

PADERNO®

WORLD CUISINE

PARTNER OF THE BEST CUISINE



2020

ICONS - SIMBOLOGIA - SYMBOLE - SYMBOLES - ICONOS

ABS Copolymer, acrylonitrile-butadiene-styrene
Copolimero, acrilonitrile-butadiene-stirene

AG Silverplated
Argentato

AQ
PVD Antique PVD

AR Natural slate
Ardesia naturale

AY Acrylic
Acrilico

B Bamboo

BC Bone china

BPA
FREE Without bisphenol A
Senza bisfenolo A

FE Metal
Metallo

HDPE High-density polyethylene
Polietilene ad alta densità

MF Melamine
Melamina

MS Methylstyrene
Metilstirene

NEW New
Novità

NSF NSF certified
Certificato NSF

PA Polyamide (nylon)
Poliammide (nylon)

PA+
plus Polyamide (nylon 6.6) with fiberglass
Poliammide (nylon 6.6) con fibra di vetro

PR Porcelain
Porcellana

PC Polycarbonate
Policarbonato

PE Polyethylene
Polietilene

PMMA Polymethylmethacrylate, plexiglass
Polimetilmetacrilato, plexiglas

PPE Phenylene ether-expanded polypropylene
Etere di polifenilene-polipropilene espanso

PP Polypropylene
Polipropilene

PS Polystyrene
Polistirene/polistirolo

PVD Physical vapor deposition
Deposizione fisica da vapore

R Natural rattan
Rattan naturale

SAN Acrylonitrile-styrene copolymer
Copolimero acrilonitrile-stirene

SS Stainless steel
Acciaio inox

VG Vintage

VG
PVD Vintage PVD

W Wood
Legno

Spare parts, index, sales terms
Ricambi, indice, condizioni di vendita
Ersatzteile, Index, Verkaufsbedingungen
Pièces de rechange, index, conditions de vente
Repuestos, índice, condiciones de venta

477





Factory

A COMPLETE RANGE FOR EVERY NEED IN THE KITCHEN. MORE THAN 10.000 ITEMS DEDICATED TO CHEFS AND PASSIONATE GOURMANDS.

From the cookware to the kitchen utensils, then knives, bakery items and tools for every kind of preparation, Paderno offers a complete selection for the best kitchens of houses and restaurants. A brand that finds its origins back in 1925 in Milan as "Alluminio Paderno", specializing in household cookware before it decided to focus on the professional cooking world. With over 90 years of history and a strong worldwide presence, Paderno is the premier choice for professionals in the catering sector. In addition to the production items, the brand offers a remarkable range of complementary articles, carefully selected and crafted by highly qualified companies.

UNA GAMMA COMPLETA PER OGNI ESIGENZA IN CUCINA. OLTRE 10.000 ARTICOLI COMPONGONO L'OFFERTA DEDICATA A CHEF E APPASSIONATI GOURMET.

Dal pentolame agli utensili cucina, passando per coltelli, articoli da pasticceria e strumenti per ogni tipo di preparazione, Paderno offre una selezione completa per le migliori cucine di case e ristoranti. Il Brand trova le sue origini nel 1925 nei pressi di Milano come Alluminio Paderno, specializzato nel settore della cucina casalinga per poi passare al settore professionale. Forte di oltre 90 anni di storia e di una presenza capillare in tutto il mondo, Paderno è il punto di riferimento per tutti i professionisti della ristorazione. Agli articoli di produzione il brand affianca un'importante gamma di prodotti complementari e affini, accuratamente selezionati e realizzati da ditte altamente qualificate.

Ho.Re.Ca.

T 0321 19 16 601

F 0321 19 16 890

horeca@paderno.it
horeca@sambonet.it

Retail

T 0321 19 16 701

F 0321 19 16 830

retail.italia@sambonet.it
retail.international@sambonet.it

Return

T 0321 19 16 635 - 759

returns@sambonet.it

www.paderno.it

www.hotel.paderno.it

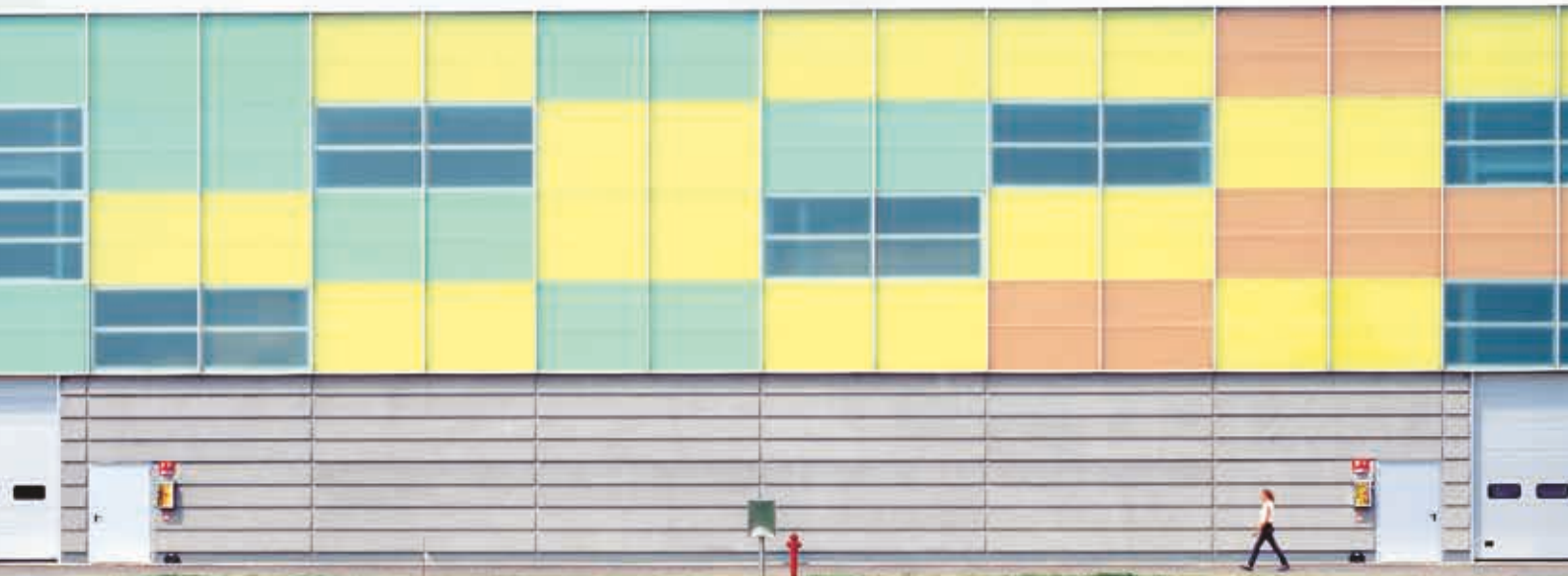

Green & Human

The respect for the environment and for the people is a relevant issue for Sambonet Paderno Industrie S.p.A. Corporate Responsibility. The commitment to sustainable growth on which the Group was founded has been maintained and permits both to guarantee adequate working conditions in order to satisfy the changing needs of the staff and to apply solutions aimed at reducing the environmental impact. From this perspective, the management of energy, electricity and water consumption focuses on:

- the use of electrical energy: clean, renewable and in harmony with the environment;
- the use of methane as the sole fuel source;
- the use of ground water for the manufacturing process, to be fully purified before being released into the environment;
- the use of an advanced energy-saving technology.

Sustainability Report

Sambonet Paderno Industrie S.p.A. strives to implement forms of measurement to assess the punctuality, the transparency and the efforts made for sustainable development. This has led to the preparation of the corporate charter of principles, 10 principles, 10 commitments, on which the Company builds its industrial future from a perspective based on preventive approach and stewardship.

Corporate Sustainability Report

corporate.sambonet.it/csr.html

The **UNI EN ISO 14001:2004** environmental certification is the recognition that the environmental policy results in a continuous improvement of environmental performance by minimising the negative impact of its operations on the environment.

The voluntary compliance with the standard **UNI EN ISO 50001:2011** demonstrates the company's commitment and vision towards responsible energy consumption, factoring in both the economic hope of reducing consumption and, above all, the desire to increase environmental awareness about reducing greenhouse gas emissions.

The **OHSAS 18001:2007** safety certification has the objective of protecting the safety of the workplace and the health of workers. Sambonet Paderno Industrie S.p.A. is the first Italian company in its sector that has obtained this certification.

Social Responsibility

Sustainability, transparency and interaction with stakeholders are the integral components that the Corporate Social Responsibility policy of Sambonet Paderno Industries S.p.A. are comprised of. The company's requirements, commitment and path taken in this area led it to obtain an SR10 certification in 2016 - the first in the sector. This important goal represents an objective guarantee in terms of attention in the interaction with stakeholders such as employees, customers, suppliers, local communities and associations in the area.

WHP Health Promoting Workplace

This socially responsible role has recently prompted the company to join the European Network for Health Promoting Workplace (WHP), establishing itself as one of the pioneers of its territory. The project foresees that the company not only implements all the measures to prevent accidents and illnesses in the workplace but - and above all - that it also undertakes to offer its workers opportunities to improve their health, through the promotion of a wholesome lifestyle mentally, physically and emotionally.

Il rispetto dell'ambiente e della persona sono temi rilevanti all'interno della responsabilità d'impresa di Sambonet Paderno Industrie S.p.A. Il Gruppo ha impostato e sviluppa tutt'oggi la propria evoluzione con un impegno di crescita sostenibile garantendo condizioni lavorative che possano soddisfare i bisogni delle persone nei differenti momenti della loro vita aziendale e applicando soluzioni volte a diminuire l'impronta ecologica. In quest'ottica, la gestione dei consumi energetici, elettrici e idrici è orientata a:

- impiegare energia elettrica pulita e rinnovabile;
- utilizzare il metano come unica fonte di combustibile;
- servirsi, per la produzione, di acqua di falda da restituire all'ambiente completamente depurata;
- usare tecnologia di risparmio energetico avanzata.

Sambonet Paderno Industrie S.p.A. lavora per attuare forme di misurazione che siano in grado di documentare la puntualità, la trasparenza e l'impegno messo in atto per uno sviluppo sostenibile. Da qui la creazione della propria carta dei principi, 10 principi, 10 impegni su cui, attraverso un approccio preventivo e una gestione responsabile, l'Azienda costruisce il proprio futuro industriale.

Bilancio di Sostenibilità dell'Azienda

corporate.sambonet.it/csr.html

UNI EN ISO 14001:2004 La certificazione ambientale garantisce i risultati di una politica ambientale volta al continuo miglioramento delle proprie performance minimizzando ogni impatto negativo delle sue attività verso l'ambiente.

UNI EN ISO 50001:2011 L'adesione volontaria alla norma UNI EN ISO 50001:2011 testimonia l'impegno e la visione dell'azienda verso l'ottimizzazione del consumo responsabile dell'energia, sia in termini economici auspicando a una riduzione dei consumi, e soprattutto verso una crescente attenzione ambientale diminuendo le emissioni di gas serra.

OHSAS 18001:2007 La certificazione ha l'obiettivo di tutelare la sicurezza e la salute dei propri lavoratori e dell'ambiente lavorativo. Sambonet Paderno Industrie S.p.A. è la prima Azienda appartenente al settore metalmeccanico ad ottenere l'attestazione.

Sostenibilità, trasparenza e interazione con gli stakeholder sono le parole chiave della politica di Corporate Social Responsibility di Sambonet Paderno Industrie S.p.A..

I requisiti, l'impegno e il percorso intrapreso dall'azienda in questo ambito, l'ha portata nel 2016 - prima nel settore - a conseguire la certificazione SR10. Questo importante traguardo rappresenta una garanzia oggettiva in fatto di attenzione nell'interazione con gli stakeholder quali dipendenti, clienti, fornitori, comunità locali e associazioni sul territorio.

Questo ruolo socialmente responsabile ha recentemente spinto l'impresa ad aderire alla Rete Europea WHP (European Network for Health Promoting Workplace) affermandosi tra le pioniere del proprio territorio. Il progetto prevede che l'azienda non solo attui tutte le misure per prevenire infortuni e malattie sul luogo di lavoro ma - e soprattutto - che si impegni anche a offrire ai propri lavoratori opportunità per migliorare la propria salute, attraverso la promozione di uno stile di vita corretto in ambito alimentare, sportivo ed emotivo.

Certifications

UNI EN ISO 22000

Sambonet Paderno Industrie is the first company in its industry that has been awarded the EN UNI ISO 22000:2005 certification. This certification attests to the highest international standard both for the Group and for the whole food and beverage industry. The implementation of its requirements, along with the implementation of HACCP (Hazard Analysis and Critical Control Points, a hygiene system that prevents contamination hazards), ensures the provision of a safe and impeccable service to customers by meticulously and scrupulously assessing the hygienic and safety conditions of activities and products. This is a guarantee not only for HoReCa professionals, but also, and foremost, for final consumers.

UNI EN ISO 9001:2015

This quality certification ensures compliance with the requirements of the international UNI EN ISO 9001:2008 standard, which guarantees the production and sale of products that fully meet customers' needs and expectations.

NSF

Some products by Sambonet Paderno Industrie S.p.A. have obtained the prestigious NSF (National Sanitation Foundation) certification for compliance with the strict standards applied in the USA to materials in contact with foodstuffs. The NSF mark is a guarantee for manufacturers, inspectors and users.

AEO

In 2008 Sambonet Paderno Industrie S.p.A. obtained the AEO Certification for Customs Simplifications and Security and Safety, valid for the EU. This programme provides a framework for governing customs regulations, guaranteeing that the company provides a reliable and secure service within the international supply chain. In addition, in 2011, Sambonet Paderno Industrie S.p.A. obtained the mutual recognition of the AEO programme with the Japanese customs administration, thus further improving customs relations with Japan.

KNOWN CONSIGNOR

The "Known Consignor" approval issued by ENAC (Italian Civil Aviation Authority) certifies that the company is an originator of cargo suitable for carriage on any aircraft, in compliance with common safety procedures and provisions.

ECCELLENZA 2006

This prestigious certificate of Excellence, awarded by Certiquality to Sambonet Paderno Industrie S.p.A. for the implementation of an integrated Quality, Environmental and Safety management system, has been granted only to few companies in Italy that have obtained the ISO 9001, ISO 140001 and BS OHSAS 18001 certifications.

AWARD FOR EXCELLENCE

In 2006 Sambonet Paderno Industrie S.p.A. received the Award for Excellence for Innovation by Confindustria (the main organization representing Italian manufacturing and services companies) with reference to the framework for innovation of the EFQM—European Foundation for Quality Management.

UNI EN ISO 22000

Prima nel suo settore Sambonet Paderno Industrie S.p.A. ha ottenuto la certificazione EN UNI ISO 22000:2005. Così come per l'intero comparto food and beverage, anche per il Gruppo la UNI EN ISO 22000:2005 rappresenta lo standard di più alto livello su scala internazionale. L'applicazione dei suoi requisiti, congiuntamente all'applicazione dell'HACCP (Hazard Analysis and Critical Control Points, sistema di autocontrollo igienico che previene i pericoli di contaminazione), garantisce alla clientela un servizio sicuro ed impeccabile attraverso una valutazione puntuale e scrupolosa delle condizioni igieniche e sanitarie delle attività e dei prodotti. Una garanzia di tutela non solo per il personale del canale professionale ma anche, e soprattutto, per il consumatore finale.

UNI EN ISO 9001:2015

La certificazione di qualità conforme ai requisiti della normativa internazionale garantisce la produzione e la commercializzazione di prodotti che soddisfino pienamente i requisiti e le aspettative del cliente.

NSF

La certificazione è stata conseguita per alcuni prodotti grazie al superamento delle rigorose norme applicate negli USA circa i materiali a contatto con gli alimenti. Il marchio NSF (National Sanitation Foundation) è sinonimo di garanzia per i costruttori, ispettori ed utilizzatori.

AEO

La certificazione comunitaria AEO Semplificazioni doganali e Sicurezza, conseguita nel 2008, garantisce un'attività disciplinata della regolamentazione doganale dell'azienda qualificandola in fatto di affidabilità e sicurezza nella catena di approvvigionamento internazionale. Nel 2011, inoltre, Sambonet Paderno Industrie S.p.A. ha ottenuto il mutuo riconoscimento del programma AEO con l'amministrazione doganale giapponese, condizione che favorisce ulteriormente i rapporti con il paese.

MITTENTE CONOSCIUTO

L'approvazione "Mittente Conosciuto" rilasciata da ENAC (Ente Nazionale Aviazione Civile) riconosce l'Azienda come sito d'origine di merce idonea al trasporto su aeromobili di qualsiasi tipo, in conformità alle procedure e disposizioni comuni di sicurezza.

ECCELLENZA 2006

Certiquality ha attribuito a Sambonet Paderno Industrie S.p.A. il Certificato di Eccellenza per aver implementato un sistema di gestione integrata di Qualità, Ambiente e Sicurezza. L'ambito riconoscimento è ottenuto da poche aziende in Italia certificate ISO 9001, ISO 140001 e BS OHSAS 18001.

AWARD FOR EXCELLENCE

Nel 2006 Sambonet Paderno Industrie S.p.A. è stata insignita dell'Award for Excellence per l'innovazione, rilasciato da Confindustria in riferimento al framework per l'innovazione dell'EFQM—European Foundation for Quality Management.





The items produced and sold by Sambonet Paderno Industrie S.p.A. not only comply with applicable regulations, but are also systematically tested. The Company can guarantee the suitability and safety of its products as it has established a specific workgroup and the ASEC Lab (Alimentary Security Control) internal laboratory, which analyses the materials intended to come into contact with foodstuffs. The laboratory is now accredited to carry out migration testing on steel, aluminum, porcelain, glass, entirely plastic materials and coloring in order to issue declarations of compliance, recognized by both national and international governments. The ASEC Lab is also accredited to determine pH levels, solvents and metals in water discharge, a guarantee for the internal analysis of the wastewater quality.

Oltre alla conformità rispetto alle norme vigenti, gli articoli prodotti e commercializzati da Sambonet Paderno Industrie S.p.A. sono controllati in maniera sistematica. Grazie alla costituzione di un gruppo di lavoro e del laboratorio interno ASEC Lab (Alimentary Security Control), specializzato nell'analisi di materiali destinati al contatto con gli alimenti, l'Azienda è in grado di garantire l'idoneità e la sicurezza dei propri prodotti. Il laboratorio è oggi accreditato per realizzare internamente test di migrazione su acciaio, alluminio, porcellana, vetro, materiali plastici e coloranti per il rilascio di dichiarazioni di conformità, riconosciute da qualsiasi ente nazionale e internazionale. ASEC Lab è inoltre accreditato per la determinazione di pH, solventi e metalli nelle acque scarico, una garanzia per le analisi interne sulla qualità delle proprie acque di scarico.



Pentolame
Cookware, pots & pans
Kochgeschirr
Batteries de cuisine
Baterías de cocina

8



GN food pans
Contentori GN
GN-Behälter
Bacs GN
Cubetas GN

49



Kitchen utensils
Utensili da cucina
Küchenzubehöre
Ustensiles de cuisine
Utensilios de cocina

80



Knives
Coltelleria
Kochmesser
Coutellerie
Cuchilleria

136



Pastry utensils
Pasticceria
Konditorei-Artikel
La pâtisserie
Pastelería

163



Ethnic cuisine
Cucina etnica
Ethnische Küche
Cuisine ethnique
Cocina étnica

248



Bar & Ice-Cream
Bar e gelateria
Bar u. Eis-Artikel
Bar et glace
Bar y heladería

269



Table top service
Tavola
Tischservice
Service de table
Servicio de mesa

311



Buffet display and presentation
Buffet e presentazione
Buffet und Präsentation
Buffet et présentation
Presentación de buffet

361



Chaffing dishes / Trolleys
Scaldavivande / Carrelli sala
Chaffing dishes / Servicewagen
Chaffing dishes / Chariots
Chaffing dishes / Carros

402



Storage, transport, cleaning
Stoccaggio, trasporto, pulizia
Lagerung, Transport, Reinigung
Stockage, transport, nettoyage
Almacenamiento, transporte, limpieza

423



Electric appliances
Apparecchi elettrici
Elektrogeräte
Appareils électriques
Aparatos eléctricos

453



SERIES 1100

STAINLESS STEEL COOKWARE
PENTOLAME INOX



Outside and inside satin polished. Top edges mirror polished. Hollow tubular stay cool handles in stainless steel, ergonomically shaped. Extra thick edges. Double thick bottom. Sandwich thermoradiant bottom (stainless steel-aluminum-stainless steel). Concave bottom when cold and flat when hot (100% heat exploiting). Perfect for use on any type of stove, whether gas, electric, glass ceramic cooking surface or induction stove. All items have an induction suited sandwich bottom.

Finitura esterna ed interna satinata, bordo lucido. Manicatura tubolare in acciaio inox, anatomica, resistente al calore. Bordo rinforzato. Doppio spessore del fondo. Fondo termodiffusore sandwich (inox-alluminio-inox). Concavo a freddo e piano a caldo (sfruttamento del calore al 100%). Ideali per ogni tipo di cottura, gas, elettrica, vetroceramica e induzione. Tutti gli articoli sono dotati di speciale fondo termodiffusore adatto anche per piastre ad induzione.



Stock pot
Pentola
Hoher Suppentopf
Marmite traiteur
Olla recta

art.	Ø cm.	h.	lt.
11101-16	16	16	3,2
11101-20	20	20	6,2
11101-24	24	24	10,0
11101-28	28	28	16,5
11101-32	32	32	24,0
11101-36	36	36	36,0
11101-40	40	40	50,0
11101-45	45	45	70,0
11101-50	50	50	100,0



Low stock pot
Pentola bassa
Gemüsetopf
Faitout
Olla recta baja

art.	Ø cm.	h.	lt.
11105-16	16	14	2,7
11105-20	20	17	5,0
11105-24	24	21	8,5
11105-28	28	23	14,5
11105-32	32	26	22,0
11105-36	36	28	29,0
11105-40	40	32	40,0



Saucepot
Casseruola alta
Fleischtopf
Brasière
Cacerola alta

art.	Ø cm.	h.	lt.
11107-16	16	11,0	2,1
11107-20	20	13,0	4,0
11107-24	24	15,0	6,5
11107-28	28	17,5	10,8
11107-32	32	19,5	15,7
11107-36	36	21,5	22,0
11107-40	40	24,5	30,8
11107-45	45	27,5	44,0
11107-50	50	32,0	63,0



Casserole pot
Casseruola bassa
Bratentopf
Sautoir
Cacerola baja

art.	Ø cm.	h.	lt.
11109-16	16	7,5	1,3
11109-20	20	8,0	2,5
11109-24	24	9,5	4,3
11109-28	28	11,0	6,7
11109-32	32	12,5	10,0
11109-36	36	14,0	14,2
11109-40	40	15,5	19,5
11109-45	45	17,0	27,0
11109-50	50	19,0	37,0



Colander for stock pot
Colapasta per pentola
Seiher für Suppentopf
Passoire pour marmite
Colador para olla recta

art.	Ø cm.	h.
11123-20	20	22,0
11123-24	24	26,5
11123-28	28	29,5

Suitable for both item 11105 and 11101.
Per art. 11105 e art. 11101.



Stock pot with tap
Pentola con rubinetto
Hochtopf mit Hahn
Marmite avec robinet
Olla con grifo

art.	Ø cm.	h.	lt.
11102-28	28	28	16,5
11102-32	32	32	24,0
11102-36	36	36	36,0
11102-40	40	40	50,0
11102-45	45	45	70,0
11102-50	50	50	100,0



Steamer pot, perforated bottom
Inserto a vapore, fondo forato
Dampf-Siebeinsatz
Casserole à vapeur, perforée
Cacerola base perforada

art.	Ø cm.	h.
11119-20	20	12,5
11119-24	24	15,0
11119-28	28	17,0
11119-32	32	19,0



11161

11119

11105



Saucepan
Casseruola alta
Stielkasserolle, hoch
Casserole haute
Cazo recto alto

art.	Ø cm.	h.	lt.
11106-14	14	8,0	1,2
11106-16	16	11,0	2,1
11106-20	20	13,0	4,0
11106-24	24	15,0	6,5
11106-28*	28	17,5	10,8
11106-32*	32	19,5	15,7
11106-36*	36	21,5	22,0

*With loop handle. – Con contromaniglia.



Sauté pan

Casseruola bassa
Stielkasserolle, niedrig
Plat à sauter
Cazo recto bajo

art.	Ø cm.	h.	lt.
11108-16	16	6,5	1,3
11108-20	20	8,0	2,5
11108-24	24	9,5	4,3
11108-28*	28	11,0	6,7
11108-32*	32	12,5	10,0
11108-36*	36	14,0	14,2

*With loop handle. – Con contromaniglia.



Sauté pan

Casseruola conica
Sauteuse
Sauteuse
Cazo cónico

art.	Ø cm.	h.	lt.
11112-16	16	6,0	1,0
11112-18	18	6,0	1,2
11112-20	20	6,5	1,6
11112-24	24	7,5	2,7



Curved sauté pan

Casseruola "bombé"
Sauteuse mit Schütterand
Sauteuse bombé
Cazo bombeado

art.	Ø cm.	h.	lt.
11113-18	18	7,0	1,7
11113-20	20	7,5	2,2
11113-24	24	8,5	3,3
11113-26	26	9,0	4,2



Frypan

Padella
Bratpfanne
Poêle à frire
Sartén

art.	Ø cm.	h.
11114-20	20	5,0
11114-24	24	5,0
11114-28	28	5,5
11114-32	32	6,0
11114-36*	36	6,0
11114-40*	40	6,0
11114-45*	45	6,5

*With loop handle. – Con contromaniglia.



Frypan, non stick coating

Padella, antiaderente
Bratpfanne mit Antihftbeschichtung
Poêle avec revêtement anti-adhésif
Sartén antiaderente

art.	Ø cm.	h.
11117-20	20	5,0
11117-24	24	5,0
11117-28	28	5,5
11117-32	32	6,0
11117-36	36	6,0
11117-40	40	6,0



French omelet pan

Tegame
Servierpfanne
Poêle à paella
Paellera

art.	Ø cm.	h.
11115-20	20	5,0
11115-24	24	5,0
11115-28	28	5,5
11115-32	32	6,0
11115-36	36	6,0
11115-40	40	6,0
11115-45	45	6,5
11115-50	50	8,0



Cover, reinforced edge

Coperchio, bordo rinforzato
Deckel mit Randverstärkung
Couvercle, bord renforcé
Tapa, borde reforzado

art.	Ø cm.
11161-12	12
11161-14	14
11161-16	16
11161-18	18
11161-20	20
11161-22	22
11161-24	24
11161-28	28
11161-32	32
11161-36	36
11161-40	40
11161-45	45
11161-50	50
11161-60	60



SERIES 2100

STAINLESS STEEL COOKWARE
PENTOLAME INOX



The serie 2100 has the same characteristics of the serie 1100. It varies only for the shape of the handles of 2 handles items. Perfect for use on any type of stove, whether gas, electric, glass ceramic cooking surface or induction stove. All items have an induction suited sandwich bottom.

La serie 2100 ha le stesse caratteristiche della serie 1100. Differisce solo per una diversa manicatura sugli articoli a 2 maniglie. Ideali per ogni tipo di cottura, gas, elettrica, vetroceramica e induzione. Tutti gli articoli sono dotati di speciale fondo termodiffusore adatto anche per piastre ad induzione.



Stock pot
Pentola
Hoher Suppentopf
Marmite traiteur
Olla recta

art.	Ø cm.	h.	lt.
12101-16	16	16	3,2
12101-20	20	20	6,2
12101-24	24	24	10,0
12101-28	28	28	16,5
12101-32	32	32	24,0
12101-36	36	36	36,0
12101-40	40	40	50,0
12101-45	45	45	70,0
12101-50	50	50	100,0



Saucepot
Casseruola alta
Fleischtopf
Brasière
Cacerola alta

art.	Ø cm.	h.	lt.
12107-16	16	11,0	2,1
12107-20	20	13,0	4,0
12107-24	24	15,0	6,5
12107-28	28	17,5	10,8
12107-32	32	19,5	15,7
12107-36	36	21,5	22,0
12107-40	40	24,5	30,8
12107-45	45	27,5	44,0
12107-50	50	32,0	63,0



Casserole pot
Casseruola bassa
Bratentopf
Sautoir
Cacerola baja

art.	Ø cm.	h.	lt.
12109-16	16	7,5	1,3
12109-20	20	8,0	2,5
12109-24	24	9,5	4,3
12109-28	28	11,0	6,7
12109-32	32	12,5	10,0
12109-36	36	14,0	14,2
12109-40	40	15,5	19,5
12109-45	45	17,0	27,0
12109-50	50	19,0	37,0

SERIES 1000

STAINLESS STEEL COOKWARE
PENTOLAME INOX



Outside and inside satin polished. Non-drip edge. Hollow tubular stay cool handles in stainless steel, ergonomically shaped. Uniform thickness in sides and bottoms. Sandwich thermoradiant bottom (stainless steel-aluminum-stainless steel). Concave bottom when cold and flat when hot (100% heat exploiting). Perfect for use on any type of stove, whether gas, electric, glass ceramic cooking surface or induction stove. All items have an induction suited sandwich bottom.

Finitura esterna ed interna satinata. Bordo a versare. Manicatura tubolare in acciaio inox, anatomica, resistente al calore. Parete e fondo a spessore uniforme. Fondo termodiffusore sandwich (inox-alluminio-inox). Concavo a freddo e piano a caldo (sfruttamento del calore al 100%). Ideali per ogni tipo di cottura, gas, elettrica, vetroceramica e induzione. Tutti gli articoli sono dotati di speciale fondo termodiffusore adatto anche per piastre ad induzione.



Stock pot

Pentola
Hoher Suppentopf
Marmite traiteur
Olla recta

art.	Ø cm.	h.	lt.
11001-16	16	16,0	3,2
11001-18	18	16,0	4,0
11001-20	20	18,0	5,5
11001-22	22	22,0	8,3
11001-24	24	24,0	10,5
11001-28	28	28,0	17,0
11001-32	32	27,5	20,4
11001-36	36	36,0	36,5
11001-40	40	40,0	50,0
11001-45	45	40,0	63,5
11001-50	50	50,0	98,0
11001-60	60	55,0	150,0



Saucepot

Casseruola alta
Fleischtopf
Brasière
Cacerola alta

art.	Ø cm.	h.	lt.
11007-16	16	9,5	1,9
11007-18	18	10,8	2,7
11007-20	20	12,0	3,8
11007-22	22	13,0	5,0
11007-24	24	14,5	6,5
11007-28	28	16,0	9,8
11007-32	32	19,5	15,4
11007-36	36	21,5	20,5
11007-40	40	24,0	30,1
11007-45	45	27,0	42,9
11007-50	50	30,0	58,0
11007-60	60	35,0	99,0



Casserole pot

Casseruola bassa
Bratentopf
Sautoir
Cacerola baja

art.	Ø cm.	h.	lt.
11009-16	16	6,5	1,3
11009-18	18	7,0	1,8
11009-20	20	7,5	2,5
11009-24	24	8,0	3,7
11009-28	28	9,5	5,8
11009-32	32	11,0	9,2
11009-36	36	13,0	13,0
11009-40	40	14,5	18,0
11009-45	45	15,5	24,6
11009-50	50	19,0	37,0
11009-60	60	25,0	70,7



Saucepan

Casseruola mezza alta
Bratentopf, mittelhoch
Casserole
Cacerola francés

art.	Ø cm.	h.	lt.
11010-16	16	8	1,6
11010-18	18	9	2,3
11010-20	20	10	3,1
11010-24	24	12	5,4



Sauté pan

Casseruola conica
Sauteuse
Sauteuse
Cazo cónico

art.	Ø cm.	h.	lt.
11012-16	16	6,0	1,0
11012-18	18	6,0	1,2
11012-20	20	6,5	1,6
11012-24	24	7,5	2,7



Curved sauté pan

Casseruola bombé
Sauteuse mit Schüttrand
Sauteuse bombé
Cazo bombeado

art.	Ø cm.	h.	lt.
11013-18	18	7,0	1,7
11013-20	20	7,5	2,2
11013-24	24	8,5	3,3
11013-26	26	9,0	4,2





Saucepan

Casseruola alta
Stielkasserolle, hoch
Casserole haute
Cazo recto alto

art.	Ø cm.	h.	lt.
11006-12	12	7,0	0,8
11006-14	14	8,0	1,2
11006-16	16	9,5	1,9
11006-18	18	10,8	2,7
11006-20	20	12,0	3,8
11006-22	22	13,0	5,0
11006-24	24	14,5	6,5
11006-28*	28	16,0	9,8
11006-32*	32	19,5	15,4
11006-36*	36	21,5	20,5

*With loop handle. – Con contromaniglia.



Saucepan

Casseruola mezza alta
Stielkasserolle, mittelhoch
Casserole
Cazo recto francés

art.	Ø cm.	h.	lt.
11011-16	16	8	1,6
11011-18	18	9	2,3
11011-20	20	10	3,1
11011-24	24	12	5,4



Sauté pan

Casseruola bassa
Stielkasserolle, niedrig
Plat à sauter
Cazo recto bajo

art.	Ø cm.	h.	lt.
11008-16	16	6,5	1,3
11008-18	18	7,0	1,8
11008-20	20	7,5	2,5
11008-24	24	8,0	3,7
11008-28*	28	9,5	5,8
11008-32*	32	11,0	9,2
11008-36*	36	13,0	13,0

*With loop handle. – Con contromaniglia.



Frypan

Padella
Bratpfanne
Poêle à frire
Sartén

art.	Ø cm.	h.
11014-20	20	5,0
11014-24	24	5,0
11014-28	28	5,5
11014-32	32	6,0
11014-36*	36	6,0
11014-40*	40	6,0
11114-45*	45	6,5

*With loop handle. – Con contromaniglia.



Frypan, non stick

Padella, antiaderente
Bratpfanne, nichttaftend
Poêle, anti-adhérente
Sartén antiadherente

art.	Ø cm.	h.
11117-20	20	5,0
11117-24	24	5,0
11117-28	28	5,5
11117-32	32	6,0
11117-36	36	6,0
11117-40	40	6,0



French omelet pan

Tegame
Servierpfanne
Poêle à paella
Paellera

art.	Ø cm.	h.
11115-20	20	5,0
11115-24	24	5,0
11115-28	28	5,5
11115-32	32	6,0
11115-36	36	6,0
11115-40	40	6,0
11115-45	45	6,5
11115-50	50	8,0



Cover

Coperchio
Deckel
Couvercle
Tapa

art.	Ø cm.
11061-12	12
11061-16	16
11061-18	18
11061-20	20
11061-22	22
11061-24	24
11061-28	28
11061-32	32
11061-36	36
11061-40	40
11061-45	45
11061-50	50
11161-60	60



SERIES 2000

STAINLESS STEEL COOKWARE
PENTOLAME INOX



The serie 2000 has the same characteristics of the serie 1000. It varies only for the shape of the handles of 2 handles items. Perfect for use on any type of stove, whether gas, electric, glass ceramic cooking surface or induction stove. All items have an induction suited sandwich bottom.

La serie 2000 ha le stesse caratteristiche della serie 1000. Differisce solo per una diversa manicatura sugli articoli a 2 maniglie. Ideali per ogni tipo di cottura, gas, elettrica, vetroceramica e induzione. Tutti gli articoli sono dotati di speciale fondo termodiffusore adatto anche per piastre ad induzione.



Stock pot

Pentola
Hoher Suppentopf
Marmite traiteur
Olla recta

art.	Ø cm.	h.	lt.
12001-16	16	16,0	3,2
12001-18	18	16,0	4,0
12001-20	20	18,0	5,5
12001-22	22	22,0	8,3
12001-24	24	24,0	10,5
12001-28	28	28,0	17,0
12001-32	32	27,5	20,4
12001-36	36	36,0	36,5
12001-40	40	40,0	50,0
12001-45	45	40,0	63,5
12001-50	50	50,0	98,0
12001-60	60	55,0	150,0



Saucepot

Casseruola alta
Fleischtopf
Brasière
Cacerola alta

art.	Ø cm.	h.	lt.
12007-16	16	9,5	1,9
12007-18	18	10,8	2,7
12007-20	20	12,0	3,8
12007-22	22	13,0	5,0
12007-24	24	14,5	6,5
12007-28	28	16,0	9,8
12007-32	32	19,5	15,4
12007-36	36	21,5	20,5
12007-40	40	24,0	30,1
12007-45	45	27,0	42,9
12007-50	50	30,0	58,0
12007-60	60	35,0	99,0



Casserole pot

Casseruola bassa
Bratentopf
Sautoir
Cacerola baja

art.	Ø cm.	h.	lt.
12009-16	16	6,5	1,3
12009-18	18	7,0	1,8
12009-20	20	7,5	2,5
12009-24	24	8,0	3,7
12009-28	28	9,5	5,8
12009-32	32	11,0	9,2
12009-36	36	13,0	13,0
12009-40	40	14,5	18,0
12009-45	45	15,5	24,6
12009-50	50	19,0	37,0
12009-60	60	25,0	70,7



Sauté pan

Casseruola conica
Sauteuse
Sauteuse
Cazo cónico

art.	Ø cm.	h.	lt.
11012-16	16	6,0	1,0
11012-18	18	6,0	1,2
11012-20	20	6,5	1,6
11012-24	24	7,5	2,7



Curved sauté pan

Casseruola bombé
Sauteuse mit Schüttrand
Sauteuse bombé
Cazo bombeado

art.	Ø cm.	h.	lt.
11013-18	18	7,0	1,7
11013-20	20	7,5	2,2
11013-24	24	8,5	3,3
11013-26	26	9,0	4,2



Saucepan

Casseruola mezza alta
Stielkasserolle, mittelhoch
Casserole
Cazo recto francés

art.	Ø cm.	h.	lt.
11011-16	16	8,0	1,6
11011-18	18	9,0	2,3
11011-20	20	10,0	3,1
11011-24	24	12,0	5,4



Asparagus-pot with lid

Pentola cuociasparagi con coperchio
Spargeltopf mit Deckel
Cuit-asperges avec couvercle
Olla espárragos con tapa

art.	Ø cm.	h.	lt.
12037-16	16	24,0	4,8



Steamer pot, perforated bottom

Inserto a vapore, fondo forato
Dampf-Siebeinsatz
Casserole à vapeur, perforée
Cacerola base perforada

art.	Ø cm.	h.
12119-20	20	12,5
12119-24	24	15,0
12119-28	28	17,0
12119-32	32	19,0



Saucepan

Casseruola alta
Stielkasserolle, hoch
Casserole haute
Cazo recto alto

art.	Ø cm.	h.	lt.
11006-12	12	7,0	0,8
11006-14	14	8,0	1,2
11006-16	16	9,5	1,9
11006-18	18	10,8	2,7
11006-20	20	12,0	3,8
11006-22	22	13,0	5,0
11006-24	24	14,5	6,5
11006-28*	28	16,0	9,8
11006-32*	32	19,5	15,4
11006-36*	36	21,5	20,5

*With loop handle. – Con contromaniglia.



Sauté pan

Casseruola bassa
Stielkasserolle, niedrig
Plat à sauter
Cazo recto bajo

art.	Ø cm.	h.	lt.
11008-16	16	6,5	1,3
11008-18	18	7,0	1,8
11008-20	20	7,5	2,5
11008-24	24	8,0	3,7
11008-28*	28	9,5	5,8
11008-32*	32	11,0	9,2
11008-36*	36	13,0	13,0

*With loop handle. – Con contromaniglia.



Frypan

Padella
Bratpfanne
Poêle à frire
Sartén

art.	Ø cm.	h.
11014-20	20	5,0
11014-24	24	5,0
11014-28	28	5,5
11014-32	32	6,0
11014-36*	36	6,0
11014-40*	40	6,0
11114-45*	45	6,5

*With loop handle. – Con contromaniglia.



Frypan, non stick

Padella, antiaderente
Bratpfanne, nichttaftend
Poêle, anti-adhérente
Sartén antiadherente

art.	Ø cm.	h.
11117-20	20	5,0
11117-24	24	5,0
11117-28	28	5,5
11117-32	32	6,0
11117-36	36	6,0
11117-40	40	6,0



French omelet pan

Tegame
Servierpfanne
Poêle à paella
Paellera

art.	Ø cm.	h.
11115-20	20	5,0
11115-24	24	5,0
11115-28	28	5,5
11115-32	32	6,0
11115-36	36	6,0
11115-40	40	6,0
11115-45	45	6,5
11115-50	50	8,0



Cover

Coperchio
Deckel
Couvercle
Tapa

art.	Ø cm.
11061-16	16
11061-18	18
11061-20	20
11061-22	22
11061-24	24
11061-28	28
11061-32	32
11061-36	36
11061-40	40
11061-45	45
11061-50	50
11161-60	60



FOR GLUTEN-FREE COOKING



AL SERVIZIO DELLA CUCINA SENZA GLUTINE



Consistently with the functional approach, which has always marked the brand, Paderno offers a complete product line and professional tools, easily recognizable in the kitchen, which can reduce possible mistakes during their use to protect people affected by celiac disease. Developed and realized in 2013 in collaboration with Associazione Italiana Celiachia Lombardia ONLUS (Italian Society for the Celiac Disease – Lombardy Section), this project makes Sambonet Paderno Industrie S.p.A. the first company in its market that offers to the HoReCa channel a complete line of items intended for gluten-free cooking.

Some distinguished special features, such as golden PVD handles for pans and pots and a special customised logo for utensils, will allow professionals to easily identify all these items in the kitchen.

This product line aims at:

- Reducing the risk of accidental food cross-contamination;
- Making it easier for professionals to work and provide services to clients with food intolerances;
- Raising awareness on the gluten-free diet issue in the industry so as to respond to the new needs of consumers.

Coerentemente all'ottica di servizio che contraddistingue da sempre il marchio, Paderno propone una linea completa di articoli e strumenti professionali facilmente identificabili in cucina, in grado di abbattere eventuali errori durante il loro utilizzo a salvaguardia del cliente celiaco e di tutti gli intolleranti. Sviluppato e concretizzato nel 2013 in collaborazione con l'Associazione Italiana Celiachia Lombardia ONLUS, questo progetto colloca Sambonet Paderno Industrie come prima azienda del settore a offrire al canale Ho.Re.Ca una linea completa di articoli da destinare alla preparazione di pietanze senza glutine.

Attraverso alcuni elementi distintivi e differenzianti, come manici in PVD oro per pentole e padelle e personalizzazione con un logo specifico per utensili, tutti gli strumenti saranno facilmente identificabili in cucina.

Questa gamma contribuisce a:

- Diminuire il rischio di accidentali contaminazioni crociate degli alimenti;
- Facilitare il professionista nell'operare e nell'offrire un servizio a favore del cliente con intolleranze alimentari;
- Sensibilizzare il settore sul tema "gluten free" di fronte alle nuove esigenze dei consumatori.

SERIES 2500 3-PLY

STAINLESS STEEL COOKWARE
PENTOLAME INOX



Paderno serie 2500 3-ply is especially designed for professional kitchens, features super heat-conductive multi-layer construction that distributes heat from bottom to rim quickly and evenly. Outside and inside satin polished. Non-drip edge. Stainless steel handles, ergonomically shaped. Uniform thickness in sides and bottoms. Energy saving on all types of cookers. Suitable for all cooking ranges, induction hobs included. induzione.

La serie Paderno 2500 3-ply concepita per l'utilizzo nelle cucine professionali è costruita in materiale multistrato che assicura una distribuzione rapida ed uniforme del calore su tutta la superficie dell'utensile. Finitura esterna ed interna satinata. Bordo a versare. Manicatura anatomica in acciaio inox. Parete e fondo a spessore uniforme. Risparmio di energia su tutti i piani di cottura. Ideali per ogni tipo di cottura inclusa l'induzione.



Saucepot

Casseruola alta
Fleischtopf
Brasière
Cacerola alta

art.	Ø cm.	h.	lt.
12507-24	24	11,5	5,0
12507-28	28	14,0	8,5



Casserole pot

Casseruola bassa
Bratentopf
Sautoir
Cacerola baja

art.	Ø cm.	h.	lt.
12509-20	20	9,5	2,8
12509-24	24	10,5	4,7
12509-28	28	11,0	6,5



Saucepan

Casseruola mezza alta
Stielkasserolle, mittelhoch
Casserole
Cazo recto francés

art.	Ø cm.	h.	lt.
12511-16	16	7,5	1,5
12511-18	18	8,0	2,0
12511-20	20	8,8	2,5
12511-24	24	10,5	4,6



Sauté pan

Casseruola bassa
Stielkasserolle, niedrig
Plat à sauter
Cazo recto bajo

art.	Ø cm.	h.	lt.
12508-24	24	5,0	2,0



Curved sauté pan

Casseruola bombé
Sauteuse mit Schütterrand
Sauteuse bombé
Cazo bombeado

art.	Ø cm.	h.	lt.
12513-16	16	6,0	1,2
12513-18	18	6,5	1,6
12513-20	20	7,0	2,0
12513-24	24	8,5	3,8



Frypan

Padella
Bratpfanne
Poêle à frire
Sartén

art.	Ø cm.	h.
12514-20*	20	3,0
12514-24	24	5,5
12514-26	26	5,5
12514-28	28	5,5
12514-32	32	4,0
12514-36	36	4,0

*Mirror finishing. – Finitura lucida.



Wok with grid and cover

Wok c/griglia e coperchio
Wok mit Rost und Deckel
Wok avec grille et couvercle
Wok con rejilla y tapa

art.	Ø cm.	h.
12529-32	32	8



Frypan, non stick coating

Padella, antiaderente
Bratpfanne mit Antihftbeschichtung
Poêle avec revêtement anti-adhésif
Sartén antiaderente

art.	Ø cm.	h.
12517-24	24	5,5
12517-26	26	5,5
12517-28	28	5,5
12517-32	32	5,5
12517-36	36	5,5



Cover

Coperchio
Deckel
Couvercle
Tapa

art.	Ø cm.
12561-16	16
12561-18	18
12561-20	20
12561-24	24
12561-26	26
12561-28	28



Saucepot with lid

Casseruola alta, con coperchio
Fleischtopf mit Deckel
Brasière avec couvercle
Cacerola alta con tapa

art.	Ø cm.	h.	lt.
12509-12*	12	6	0,7

*Mirror finishing. – Finitura lucida.



Sauté pan with double spouts

Casseruola bassa con doppio becco
Stielkasserolle, niedrig, 2 Schnabel
Plat à sauter, 2 becs
Cazo recto bajo, 2 picos

art.	Ø cm.	h.	lt.
12511-10*	10	5	0,4

*Mirror finishing. – Finitura lucida.



Sauté pan

Casseruola bassa
Stielkasserolle, niedrig
Plat à sauter
Cazo recto bajo

art.	Ø cm.	h.	lt.
12511-12*	12	6	0,7
12511-14*	14	7	1,0

*Mirror finishing. – Finitura lucida.

MISCELLANEOUS COMPLEMENTI

STAINLESS STEEL COOKWARE
PENTOLAME INOX

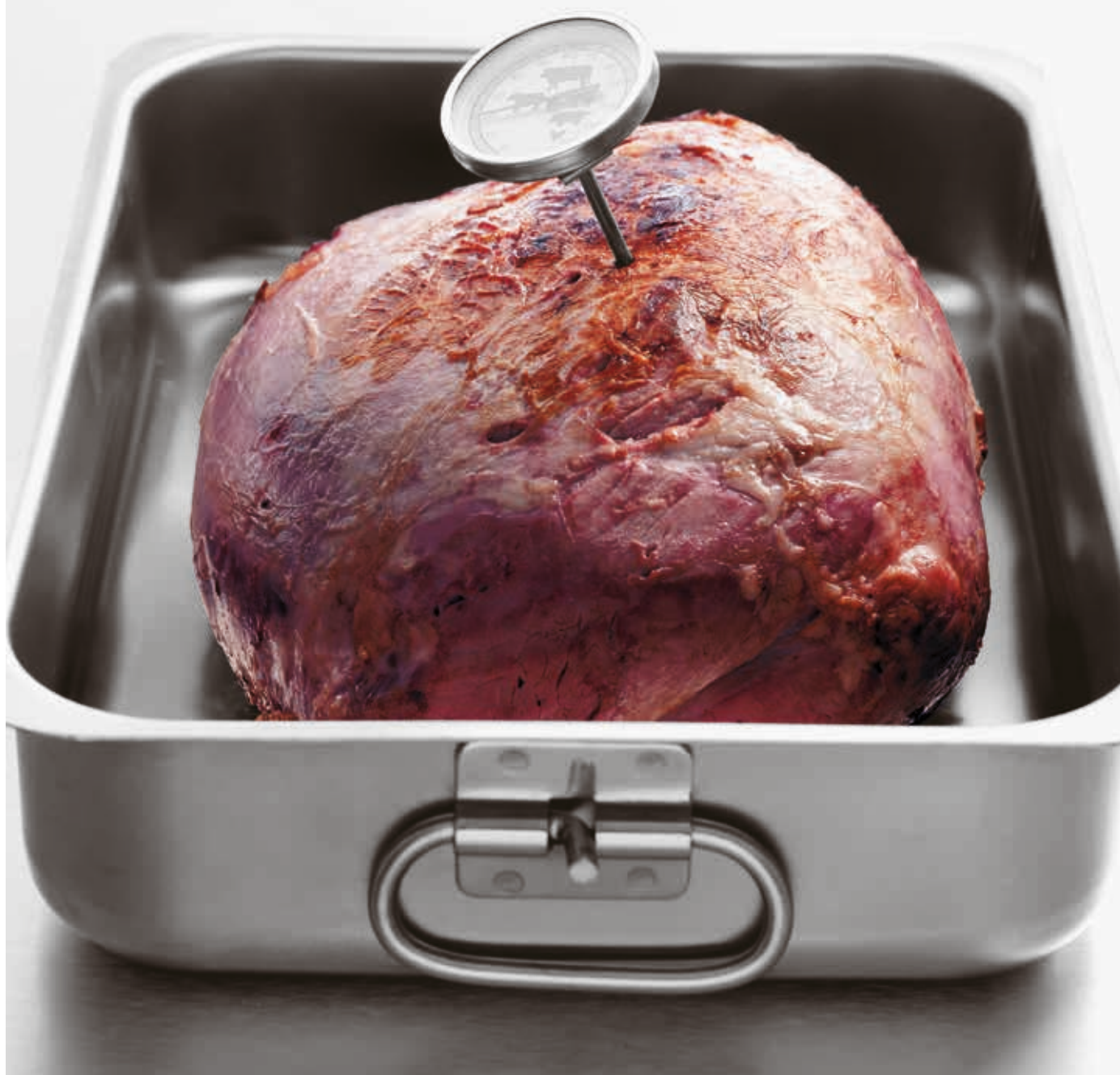



Roasting pan

Tegame
Bräter
Plaque à rôtir
Rustidera

art.	cm.	h.
11941-35	35x25	8
11941-40	40x26	9
11941-45	45x30	9
11941-50	50x30	9
11941-60	60x35	9



Heavy roasting pan

Tegame pesante
Bräter, Schwerausführung
Plaque à rôtir lourde
Rustidera pesada

art.	cm.	h.
11943-40	40x26	9
11943-45	45x30	9
11943-50	50x30	9
11943-60	60x35	9
11943-61*	61x43	9

*For 2/1 GN ovens. – Per forno GN 2/1.



Heavy roasting pan

Tegame pesante
Bräter, Schwerausführung
Plaque à rôtir lourde
Rustidera pesada

art.	cm.	h.
11944-40	40x26	9
11944-45	45x30	9
11944-50	50x30	9
11944-60	60x35	9
11944-61*	61x43	9

*For 2/1 GN ovens. – Per forno GN 2/1.



Lid

Coperchio
Deckel
Couvercle
Tapa

art.	cm.
11948-40	40x26
11948-45	45x30
11948-50	50x30
11948-60	60x35
11948-61*	61x43

*For 2/1 GN ovens. – Per forno GN 2/1.



Roasting pan with cover

Brasiera con coperchio
Brasiere mit Deckel
Braisière avec couvercle
Rustidera alta con tapa

art.	cm.	h.
11965-50	50x30	15
11965-60	60x35	15
11965-61*	61x43	15

*For 2/1 GN ovens. – Per forno GN 2/1.



Fish kettle

Pesciera
Fischkochkessel
Poissonnière
Hervidor pescado

art.	cm.	h.	lt.
11963-99	100x25	20	44

Equipped with grid and cover.
Fornita con griglia e coperchio.



Fish kettle

Pesciera
Fischkochkessel
Poissonnière
Hervidor pescado

art.	cm.	h.
41964-45	46x15,5	10,5
41964-60	61,5x18,5	11,0

Equipped with grid and cover.
Fornita con griglia e coperchio.



Whistling kettle

Bollitore
Kocher
Bouilloire à sifflet
Pava

art.	lt.
41914-03	2,8



Fry dripping tray, stainless steel

Colafritto, inox
Pommes-Frites-Seiher, Edelstahl Rostfrei
Egouttoir à friture, inox
Escurridor para fritura, inox

art.	Ø cm.	h.
41930-39	41	14

Detachable drip tray.
Vassoio raccogli liquidi removibile.



Canister

Contentitore cilindrico

Behälter

Bahut

Contenedor cilíndrico

art.	Ø cm.	h.	lt.
11913-16	16	12	2,4
11913-20	20	16	5,0
11913-24	24	20	9,0
11913-28	28	24	14,5



Bain-marie pot

Casseruola bagnomaria

Wasserbadkasserolle

Casserole bain-marie

Baño maria

art.	Ø cm.	h.	lt.
11910-12	12	14	1,4
11910-14	14	16	2,5
11910-16	16	18	3,6
11910-18	18	20	5,0
11910-20	20	22	7,0



Bain-marie pot

Bagnomaria

Behälter

Casserole bain-marie

Baño maria

art.	Ø cm.	h.	lt.
11911-12	12	14	1,4
11911-14	14	16	2,5
11911-16	16	18	3,6
11911-18	18	20	5,0
11911-20	20	22	7,0



Bain-marie, stackable

Bagno-maria impilabili

Bain-Marie, stapelbar

Bain-marie, empilables

Baño maria, apilable

art.	cm.	h.	lt.
44501-01	24x24	23,5	13,0
44501-02	24x24	16,0	9,0
44501-03	24x24	7,5	4,0



Bain-marie, stackable

Bagno-maria impilabili

Bain-Marie, stapelbar

Bain-marie, empilables

Baño maria, apilable

art.	cm.	h.	lt.
44502-01	15,5x15,5	23,5	5,0
44502-02	15,5x15,5	16,0	3,5
44502-03	15,5x15,5	7,5	1,5



Bain-marie, stackable

Bagno-maria impilabili

Bain-Marie, stapelbar

Bain-marie, empilables

Baño maria, apilable

art.	cm.	h.	lt.
44503-01	15,5x10,5	16,0	2,5
44503-02	15,5x10,5	7,5	1,0
44503-03	15,5x10,5	5,5	0,5



Bain-marie lid

Coperchio bagnomaria

Wasserbadkasserolle-Deckel

Couverte pour bain-marie

Tapa para baño maria

art.	cm.
44501-04	24x24
44502-04	15,5x15,5
44503-04	15,5x10,5



1/4-Segment colander

Colapasta 1/4

1/4 Seiher-Einsatz

Passoire cuit-pâtes, 1/4

Colador 1/4

art.	Ø cm.	h.	lt.
11922-36	36	23	5,5
11922-40	40	26	7,5

For items/Per art.: 11007-11107-12007-12107-16929.



1/4-Segment wire colander

Colapasta 1/4 a rete

1/4 Netzseiher-Einsatz

Passoire cuit-pâtes à gaze, 1/4

Colador red 1/4

art.	Ø cm.	h.
12992-36	36	23
12992-40	40	26

For items/Per art.: 11007-11107-12007-12107-16929.

PA+
plus

SERIES 6100

ALUMINUM COOKWARE
PENTOLAME ALLUMINIO



Made in heavy duty aluminum.
Hollow tubular handles in stainless steel 18/10, stay cool.
Rounded corners provide easy cleanup.
Thickness from mm 2 to mm 5,5.

Esecuzione in alluminio pesante.
Manicatura tubolare in acciaio inossidabile 18/10, resistente al calore.
Ampio raggio di raccordo fondo-parete, igienico e facile da pulire.
Spessore da mm 2 a mm 5,5.



Stock pot

Pentola
Hoher Suppentopf
Marmite traiteur
Olla recta

art.	Ø cm.	h.	lt.
16101-16	16	16,0	3,2
16101-20	20	20,0	6,2
16101-24	24	24,0	10,0
16101-28	28	28,0	16,5
16101-32	32	29,5	22,0
16101-36	36	36,0	36,0
16101-40	40	40,0	50,0
16101-45	45	45,0	70,0
16101-50	50	50,0	100,0



Saucepot

Casseruola alta
Fleischtopf
Brasière
Cacerola alta

art.	Ø cm.	h.	lt.
16107-16	16	11,0	2,1
16107-20	20	13,0	4,0
16107-24	24	15,0	6,5
16107-28	28	17,5	10,8
16107-32	32	19,5	15,7
16107-36	36	21,0	21,5
16107-40	40	24,0	30,0
16107-45	45	27,0	43,0
16107-50	50	30,0	59,0



Casserole pot

Casseruola bassa
Bratentopf
Sautoir
Cacerola baja

art.	Ø cm.	h.	lt.
16109-24	24	9,5	4,3
16109-28	28	11,0	6,7
16109-32	32	12,5	10,0
16109-36	36	14,0	14,0
16109-40	40	16,0	20,0
16109-45	45	18,0	28,5
16109-50	50	19,0	37,0
16109-60	60	21,5	60,0



Colander for stock pot

Colapasta per pentola
Seiher für Suppentopf
Passoire pour marmite
Colador para olla recta

art.	Ø cm.	h.
16926-32	32	31
16926-36	36	37
16926-40	40	40



Couscous pan

Couscoussiera
Couscoustopf
Couscoussier
Cuscusera

art.	Ø cm.	h.	lt.
46970-18	36	22+17	18
46970-25	40	25+20	25



Potato steamer pot with cover

Casseruola a vapore con coperchio
Kartoffeldämpfer mit Deckel
Marmite à pommes-de-terre avec couvercle
Cuscusera con tapa

art.	Ø cm.	h.	lt.
16923-32	32	21+15	12
16923-36	36	23+17	18
16923-40	40	25+20	25



Oval saucepan with cover

Casseruola ovale con coperchio
Ovale Kasserolle mit Deckel
Casserole ovale avec couvercle
Cacerola oval con tapa

art.	Ø cm.	h.	lt.
16938-36	36	14,5	10
16938-40	40	16,0	14
16938-45	45	17,0	19



Saucepan

Casseruola alta
Stielkasserolle, hoch
Casserole haute
Cazo recto alto

art.	Ø cm.	h.	lt.
16106-16	16	11,0	2,1
16106-20	20	13,0	4,0
16106-24	24	15,0	6,5
16106-28	28	17,5	10,8



Casserole pot

Casseruola bassa
Stielkasserolle, niedrig
Sautoir
Cacerola baja

art.	Ø cm.	h.	lt.
16108-20	20	8,0	2,5
16108-24	24	9,5	4,3
16108-28	28	11,0	6,7



Frypan
Padella
Bratpfanne
Poêle à frire
Sartén

art.	Ø cm.	h.
16114-20	20	4,0
16114-24	24	5,0
16114-28	28	5,0
16114-32	32	5,3
16114-36	36	6,0
16114-40	40	7,0



French omelet pan
Tegame
Servierpfanne
Poêle à paella
Paellera

art.	Ø cm.	h.
16115-24	24	5,5
16115-28	28	6,0
16115-32	32	6,5
16115-36	36	7,0
16115-40	40	7,5
16115-45	45	7,5



Cover
Coperchio
Deckel
Couvercle
Tapa

art.	Ø cm.
16961-16	16
16961-20	20
16961-24	24
16961-28	28
16961-32	32
16961-36	36
16961-40	40
16961-45	45
16961-50	50
16961-60	60



Casserole pot, non stick
Casseruola alta, antiaderente
Fleischtopf, nichtaftend
Brasière, anti-adhérente
Cacerola alta, antiadherente

art.	Ø cm.	h.	lt.
16127-16	16	11,0	2,1
16127-20	20	13,0	4,0
16127-24	24	15,0	6,5
16127-28	28	17,5	10,8
16127-32	32	19,5	15,7
16127-36	36	21,0	21,5
16127-40	40	24,0	30,0



Casserole pot, non stick
Casseruola bassa, antiaderente
Bratentopf, nichtaftend
Sautoir , anti-adhérente
Cacerola baja, antiadherente

art.	Ø cm.	h.	lt.
16120-24	24	9,5	4,3
16120-28	28	11,0	6,7
16120-32	32	12,5	10,0
16120-36	36	14,0	14,0
16120-40	40	16,0	20,0



French omelet pan, non stick
Tegame, antiaderente
Servierpfanne, nichtaftend
Poêle à paella, anti-adhérente
Paellera antiadherente

art.	Ø cm.	h.
16116-28	28	6,5
16116-32	32	6,5
16116-36	36	7,0
16116-40	40	7,5



Frypan, non stick
Padella, antiaderente
Bratpfanne, nichtaftend
Poêle, anti-adhérente
Sartén antiadherente

art.	Ø cm.	h.
41720-18	18	3,8
41720-20	20	3,8
41720-24	24	4,5
41720-28	28	5,4
41720-30	30	5,4
41720-32	32	5,6



Frypan, non stick
Padella, antiaderente
Bratpfanne, nichtaftend
Poêle, anti-adhérente
Sartén antiadherente

art.	Ø cm.	h.
16117-20	20	4,0
16117-24	24	5,0
16117-28	28	5,0
16117-32	32	5,3
16117-36	36	6,0
16117-40	40	7,0



Forged frypan, non stick
Padella forgiata, antiaderente
Pfanne, geschmiedet, nichtaftend
Poêle forgée, anti-adhérente
Sartén forjada, antiadherente

art.	Ø cm.	h.
11617-20	20	3,4
11617-24	24	4,2
11617-28	28	4,5
11617-32	32	5,5

**INDUCTION
READY!**



Frypan, non stick, cast iron handle
Padella bombata antiaderente, manico ferro
Bratpfanne, nichttaftend, Gusseisen-Stiel
Poêle bombé, anti-adhérente, queue fonte
Sartén antiadherente, mango hierro

art.	Ø cm.	h.
16113-20	20	5,5
16113-24	24	6,5
16113-28	28	7,0
16113-32	32	7,5
16113-36	36	8,0
16113-40	40	8,5



Frypan, non stick, cast iron handle
Padella antiaderente, manico ferro
Bratpfanne, nichttaftend, Gusseisen-Stiel
Poêle, anti-adhérente, queue fonte
Sartén antiadherente, mango hierro

art.	Ø cm.	h.
16717-20	20	4,0
16717-24	24	5,0
16717-28	28	5,0
16717-32	32	5,3
16717-36	36	6,0
16717-40	40	7,0



Crêpes pan, non stick
Padella crêpes, antiaderente
Crêpepfanne, nichttaftend
Poêle à crêpes, anti-adhérente
Sartén crêpes antiadherente

art.	Ø cm.
16118-24	24



Non-stick blinis pan
Padella per blini, antiaderente
Blinis-Pfännchen, nichttaftend
Poêle à blinis, anti-adhérente
Sartén blinis, antiadherente

art.	Ø cm.	h.
16719-12	12	2



Crêpes pan, non-stick
Padella crêpes antiaderente
Crêpes-Pfanne, nichttaftend
Tuile à crêpes anti-adhérente
Sartén para crêpes, antiadherente

art.	Ø cm.
16712-22	22
16712-26	26
16712-30	30



Bake roasting pan
Tegame
Pfanne
Plat à four
Rustidera

art.	cm.	h.
16941-40	40x26	7,5
16941-45	45x30	7,5
16941-50	50x30	8,0
16941-60	60x35	9,0
16941-61*	61x43	9,0

*For 2/1 GN ovens. – Per forno GN 2/1.



Bake roasting pan
Tegame
Pfanne
Plat à four
Rustidera

art.	cm.	h.
16943-40	40x26	7,5
16943-45	45x30	7,5
16943-50	50x30	8,0
16943-60	60x35	9,0
16943-61*	61x43	9,0

*For 2/1 GN ovens. – Per forno GN 2/1.



Bake roasting, non stick
Tegame, antiaderente
Pfanne, nichttaftend
Plat à four, anti-adhérente
Rustidera antiadherente

art.	cm.	h.
16947-40	40x26	7,5
16947-45	45x30	7,5
16947-50	50x30	8,0
16947-60	60x35	9,0
16947-61*	61x43	9,0

*For 2/1 GN ovens. – Per forno GN 2/1.



Lid for roasting pans
Coperchio per tegami
Deckel für Bräter
Couvercle pour plaques à rôtir
Tapa para rustidera

art.	cm.
16948-40	40x26
16948-45	45x30
16948-50	50x30
16948-60	60x35
16948-61	61x43



Bake roasting pan

Tegame basso

Pfanne, flach

Plat à four bas

Bandeja horno

art.	cm.	h.
16944-45	45x30	4
16944-50	50x30	4
16944-60	60x35	4



Roasting pan with cover

Brasiera con coperchio

Brasiere mit Deckel

Braisière avec couvercle

Rustidera alta con tapa

art.	cm.	h.	lt.
16965-40	40x26	15	14
16965-50	50x30	15	21
16965-60	60x35	15	30



Fish kettle

Pesciera

Fisch-Kochkessel

Poissonnière

Hervidor pescado

art.	cm.	h.	lt.
16939-50	50x15	12	9
16939-60	60x17	13	13
16939-70	70x19	14	18
16939-80	80x24	17	30

Equipped with grid and cover. – Fornita con griglia e coperchio.



Sauce-pot, aluminum

Casseruola, alluminio

Gemüsetopf, Aluminum

Braisière, alu

Cacerola, aluminio

art.	Ø cm.	h.	lt.
16929-36	36	17	17,0
16929-40	40	18	22,5

Supplied without colanders. – Fornita senza spicchi.



1/4-Segment wire colander

Colapasta 1/4 a rete

1/4 Netzseihier-Einsatz

Passoire cuit-pâtes à gaze, 1/4

Colador red 1/4

art.	Ø cm.	h.
12992-36	36	23
12992-40	40	26



Bain-marie pot

Bagnomaria

Wasserbadkasserolle

Casserole bain-marie

Baño maria

art.	Ø cm.	h.	lt.
16910-14	14	16	2,5
16910-16	16	18	3,7
16910-18	18	20	5,0
16910-20	20	22	7,0

STEEL FRYING PANS

PADELLE FERRO



Iron is ideal for cooking at high temperatures because its low capacity of heat transmission prevents temperature leaps. As it is non-stick, food does not stick to it. It withstands very high temperatures and improves its performance with use. Iron pans are perfect for fried food, omelettes or fine crêpes. Wash the black iron pan in water as little as possible and always keep it greased. Iron pans are ideal also for cooking on induction hobs.

Il ferro è ottimo per le cotture a fuoco molto vivo perché, non avendo un'alta capacità di trasmettere calore, evita improvvisi sbalzi di temperatura. Essendo un materiale antiaderente, evita l'attaccamento dei cibi. Sopporta temperature elevatissime e col tempo migliora il suo rendimento. I recipienti in ferro sono i più adatti per frittture, omelette o sottili crêpes. La padella in ferro nera va lavata con acqua il meno possibile e mantenuta sempre unta. Il ferro è il materiale ideale anche per cotture a induzione.



Blacksteel fish pan

Padella ovale
Fischeisenpfanne, oval
Coupe ovale
Sartén oval

art.	cm.	h.
41719-32	32x23	5,0
41719-36	36x26	5,0
41719-40	40x28	5,5



Blacksteel crêpes pan

Padella crêpes
Crêpes Eisenpfanne
Coupe lyonnaise à crêpes
Sartén crêpes

art.	Ø cm.	h.
11718-20	20	2
11718-22	22	2
11718-24	24	2



Blinis pan

Padella per blini
Blinis-Eisenpfännchen
Poêle à blinis
Sartén blinis

art.	Ø cm.	h.
11715-12	12	2



Heavy blacksteel frypan

Padella lionese, pesante
Schwere Eisenpfanne
Coupe lyonnaise extra-forte
Sartén honda pesada

art.	Ø cm.	h.
11714-20	20	3,8
11714-22	22	4,0
11714-24	24	4,5
11714-26	26	4,5
11714-28	28	4,5
11714-32	32	5,0
11714-36	36	5,5
11714-40	40	5,5
11714-45	45	5,5
11714-50	50	6,0



Blacksteel frypan

Padella lionese
Eisenpfanne
Coupe lyonnaise
Sartén honda

art.	Ø cm.	h.
11716-16	16	4,0
11716-20	20	4,5
11716-22	22	4,5
11716-24	24	5,0
11716-26	26	5,5
11716-28	28	5,5
11716-32	32	6,0
11716-36	36	6,5
11716-40	40	7,0
11716-45	45	8,0



Blacksteel paella pan

Padella per paella
Paella Eisenpfanne
Coupe lyonnaise à paella
Paellera

art.	Ø cm.	h.
11717-34	34	5,0
11717-37	37	5,5
11717-42	42	6,0
11717-47	47	6,5
41717-60	60	6,5
41717-80	80	9,0



Blacksteel fish pan

Padella ovale
Fischeisenpfanne, oval
Coupe ovale
Sartén oval

art.	cm.
41703-38	38x26



Wok pan

Wok
Wok-Pfanne
Poêle chinoise
Wok

art.	Ø cm.	h.
11713-32	32	10
11713-40	40	11



Chestnut pan

Padella per castagne
Kastanienpfanne
Poêle à marrons
Sartén para castañas

art.	Ø cm.
11721-28	28



Silicone sleeve

Coprimanico silicone
Silikon-Stielhülle
Revêtement manche en silicone
Cubre mango silicona

art.	Ø cm.	col.
11710-AA	20-36	●
11710-AB	40-50	●

Heat resistant up to 230°C. Resistenza al calore fino a 230°C. Suits items | Per art.: 16717, 16113, 16712, 11714, 11716, 11718, 11713, 11721.



Fry pan

Padella per friggere
Frittier-Pfanne
Tuile à frire
Sartén freidora

art.	Ø cm.	h.	lt.
41707-32	32	9,8	6,0
41707-36	36	11,0	8,8
41707-40	40	13,4	12,2
41707-45	45	15,0	17,3
41707-50	50	17,6	23,5



Wire basket, tinned

Cestello per friggere, stagnato
Frittier-Rost, verzinkt
Grille à frire, étamée
Cesta escurrefrito, estañada

art.	Ø cm.	h.
41708-32	32	11,0
41708-36	36	11,5
41708-40	40	12,4
41708-45	45	15,5
41708-50	50	16,5

SERIES 15500 3-PLY

COPPER COOKWARE
PENTOLAME RAME



Ideal for cooking and serving from the kitchen to the table. A working tool with a body made of three metals, copper, aluminum and steel. A mix for a homogenous and sweet thermal spread that ensures cooking without attacking the foods, preserving its nutritional properties and organoleptic characteristics. Inside stainless steel, practical and easy to clean. Middle layer aluminum, lightweight and a very good heat conductor. Exterior glossy copper finishing, a tradition in the kitchen, fascinating and beautiful to see. Solid brass handles assembled with strong section rivets. Suitable for use on all cooking hobs including induction.

Ideale per cucinare e servire nello stesso recipiente. Uno strumento di lavoro con un corpo formato da tre metalli, rame, alluminio e acciaio. Un mix per un'omogenea e dolce diffusione termica che assicura una cottura senza aggredire i cibi, preservandone le proprietà nutrizionali e le caratteristiche organolettiche. Lamina interna in acciaio inox, pratico e facile da pulire. Strato intermedio in alluminio, leggero e ottimo conduttore di calore. Esterno in rame finitura lucida, una tradizione in cucina, affascinante e bello da vedere. Manici e maniglie in ottone massiccio assemblati con rivetti di forte sezione. Adatto ad uso su tutti i fuochi inclusa l'induzione.



Saucepan

Casseruola alta
Stielkasserolle, hoch
Casserole haute
Cazo recto alto

art.	Ø cm.	h.	lt.
15506-16	16	8	1,6
15506-20	20	11	3,5
15506-24	24	14	6,3
15506-28	28	16	9,8



Casserole pot

Casseruola bassa
Stielkasserolle, niedrig
Sautoir
Cacerola baja

art.	Ø cm.	h.	lt.
15508-20	20	7	2,2
15508-24	24	8	3,6
15508-28	28	9	5,5



Frypan

Padella
Bratpfanne
Poêle à frirer
Sartén

art.	Ø cm.	h.	lt.
15514-20	20	4,5	1,4
15514-24	24	4,5	2,0
15514-28	28	5,5	3,4
15514-32	32	6,0	4,8



Saucepot

Casseruola alta
Fleischtopf
Brasière
Cacerola alta

art.	Ø cm.	h.	lt.
15507-16	16	8	1,6
15507-20	20	11	3,5
15507-24	24	14	6,3
15507-28	28	16	9,8



Casserole pot

Casseruola bassa
Bratentopf
Sautoir
Cacerola baja

art.	Ø cm.	h.	lt.
15509-20	20	7	2,2
15509-24	24	8	3,6
15509-28	28	9	5,5



Frypan

Padella
Bratpfanne
Poêle à paella
Paellera

art.	Ø cm.	h.	lt.
15515-20	20	4,5	1,4
15515-24	24	4,5	2,0
15515-28	28	5,5	3,4
15515-32	32	6,0	4,8



Cover

Coperchio
Deckel
Couvercle
Tapa

art.	Ø cm.
15561-20	20
15561-24	24
15561-28	28



MINI COOKWARE MINIATURE SERIES 15200 3-PLY

COPPER COOKWARE
PENTOLAME RAME



Paderno Serie 15200 3-ply, inside stainless steel satin polished, intermediate layer in aluminum, outside copper mirror polished. Thickness 1,8 mm. Stainless steel handles with PVD gold finishing, stainless steel rivets. For use on any heating element (except on induction hob).

Serie Paderno 15200 3-ply, lamina interna in acciaio inox finitura satinata, strato intermedio in alluminio, esterno rame lucido. Spessore 1,8 mm. Manicatura in acciaio inox con finitura PVD oro, rivetti inox. Adatte ad uso su tutti i fuochi (eccetto induzione).



NEW

Saucepan

Casseruola alta
Stielkasserolle, hoch
Casserole haute
Cazo recto alto

art.	Ø cm.	h.	lt.
15226-07	7	4,0	0,15
15228-10	10	4,5	0,35



Saucepan

Casseruola alta
Stielkasserolle, hoch
Casserole haute
Cazo recto alto

art.	Ø cm.	h.	lt.
15226-10	10	7	0,50
15226-12	12	8	0,85
15226-14	14	9	1,30



Frypan

Padella
Bratpfanne
Poêle à paella
Paellera

art.	Ø cm.	h.	lt.
15224-10	10	3,0	0,20
15224-12	12	3,5	0,35
15224-14	14	4,5	0,70



Saucepot

Casseruola alta
Fleischtopf
Brasière
Cacerola alta

art.	Ø cm.	h.	lt.
15227-10	10	7	0,50
15227-12	12	8	0,85
15227-14	14	9	1,30



Casserole pot

Casseruola bassa
Bratentopf
Sautoir
Cacerola baja

art.	Ø cm.	h.	lt.
15229-10	10	4,5	0,35



Omelet pan

Tegame
Servierpfanne
Poêle à paella
Paellera

art.	Ø cm.	h.	lt.
15225-10	10	3,0	0,20
15225-12	12	3,5	0,35
15225-14	14	4,5	0,70



Cover

Coperchio
Deckel
Couvercle
Tapa

art.	Ø cm.
15261-10	10
15261-12	12
15261-14	14



SERIES 15300-15400

COPPER COOKWARE
PENTOLAME RAME



Solid copper, thickness from 1,5 to 2,5 mm, the interiors are tinned over the fire by hand. Handles in highly polished solid brass, assembled with wide rivets. For use on any heating element (except on induction hob).

Rame massiccio, spessore da 1,5 a 2,5 mm internamente stagnato a mano sulla fiamma. Manici e maniglie in ottone massiccio lucidato a specchio ed assemblati con rivetti di forte sezione. Adatto ad uso su tutti i fuochi (eccetto induzione).



Oval saucepan
Casseruola ovale
Ovaler Bratentopf
Casserole ovale
Cacerola oval

art.	cm.	h.
15338-38	38x25	13



Bake roasting pan
Tegame rettangolare
Rechteckige Pfanne
Plat à four
Rustidera

art.	cm.	h.
15343-36	38x28	11



Oval pan
Tegame ovale
Ovale Bratpfanne
Plat ovale à poignées
Bandeja oval

art.	cm.	h.
15339-36	38x26	11



Fish kettle
Pesciera
Fischkochkessel
Poissonnière
Hervidor pescado

art.	cm.	h.
15438-50	50x18	11



Bain-marie
Bagnomaria
Wasserbadkasserolle
Bain-marie
Baño maria

art.	Ø cm.	h.
15403-16	16	17



Fondue set
Set fonduta
Fondue-Service
Service à fondue
Servicio para fondues

art.	Ø cm.	h.
15430-11	16	26

With porcelain. – Con porcellana.



Sugar saucepan
Casseruola per zucchero
Zuckerpfännchen
Poelon à sucre
Cacerola para azúcar

art.	Ø cm.	h.
15406-16	16	9
15406-20	20	10



Zabaione bowl
Casseruola per zabaione
Zabaionekasserolle
Poelon à zabaione
Cacerola sabayón

art.	Ø cm.
15407-16	16
15407-20	20



Foot for zabaione bowl
Base per casseruola zabaione
Fuss für Zabaionekasserolle
Base pour poelon à zabaione
Base para cacerola sabayón

art.	Ø cm.	h.
15401-51	8	4,5



Mixing bowl
Bastardella semisferica
Schnees Schlagkessel
Bassine hémisphérique
Caldero

art.	Ø cm.
15409-26	26
15409-30	30
15409-36	36



Bordelais moulds
Stampo scanalato
Bordelais-Kuchenform
Moule à cannelés Bordelais
Molde para bordelais

art.	Ø cm.	h. mm.
15415-03	5,5	5

3 pcs set. – Set 3 pezzi.



Sauté pan
Paiolo
Kasserolle
Sauteuse
Cazo cónico

art.	Ø cm.	h.
15412-25	25	13

Frosted finishing. – Finitura smerigliata.

MINI COOKWARE MINIATURE

COOKWARE
PENTOLAME



Aluminum body non-stick coated, brass handles. A range of small pots ideal for side dishes and individual servings, soufflés, baked pasta, rice creams, raclette, savory as well as sweet pastries, desserts, etc., etc.. Versatile, functional, ready to be served from the kitchen to the table. Original and yet traditional, they come from the world of haute cuisine, ideal for enhancing creations or the most simple recipes, for the sake of conviviality, to give a more playful aspect to our meals.

Corpo in alluminio con rivestimento antiaderente, manicatura in ottone. Una gamma di miniature ideali per contorni e singole porzioni, soufflé, pasta al forno, creme di riso, raclette, brioche salate e dolci, dessert, ecc., ecc.. Polivalenti, funzionali, pronte per essere servite dalla cucina alla tavola. Originali eppure tradizionali, provengono dal mondo dell'alta gastronomia, strumento ideale per valorizzare creazioni estrose o le più semplici ricette, per amore della convivialità, per donare un aspetto più ludico ai nostri pasti.



Saucepan

Casseruola alta
Stielkasserole, hoch
Casserole haute
Cazo recto alto

art.	Ø cm.	h.	lt.
16136-10	10	6	0,45



Sauté pan

Casseruola bassa
Stielkasserole, niedrig
Plat à sauter
Cazo recto bajo

art.	Ø cm.	h.	lt.
16138-10	10	4	0,3



Frypan

Padella
Bratpfanne
Poêle à frire
Sartén

art.	Ø cm.	h.	lt.
16134-12	12	4	0,4



Saucepan

Casseruola alta
Fleischtopf
Casserole haute
Cazo recto alto

art.	Ø cm.	h.	lt.
16137-10	10	6	0,45



Casserole pot

Casseruola bassa
Bratentopf
Sautoir
Cacerola baja

art.	Ø cm.	h.	lt.
16139-10	10	4	0,3



French omelet pan

Tegamino
Servierpfanne
Poêle à paella
Paellera

art.	Ø cm.	h.	lt.
16135-12	12	4	0,4



Blinis pan, non-stick aluminum
Padella blini, alluminio antiaderente
Blinis-Pfännchen, Alu-Nichttafend
Poêle à blinis, alu anti-adhérente
Sartén blinis, aluminio antiadherente

art.	Ø cm.	h.
16719-12	12	2



Blinis pan, steel
Padella blini, ferro
Blinis-Pfännchen, Eisen
Poêle à blinis, acier
Sartén blinis, hierro

art.	Ø cm.	h.
11715-12	12	2



Sauté pan with double spouts
Casseruola con due becchi, 3-ply
Stielkasserolle, niedrig, 2 Schnabel
Plat à sauter, 2 becs
Cazo recto bajo, 2 picos

art.	Ø cm.	h.	lt.
12511-10	10	5	0,4



Sauté pan
Casseruola bassa, 3-ply
Stielkasserolle, niedrig
Plat à sauter
Cazo recto bajo

art.	Ø cm.	h.	lt.
12511-12	12	6	0,7



Sauté pan
Casseruola bassa, 3-ply
Stielkasserolle, niedrig
Plat à sauter
Cazo recto bajo

art.	Ø cm.	h.	lt.
12511-14	14	7	1



Saucepot with lid
Casseruola con coperchio, 3-ply
Fleischtopf mit Deckel
Brasière avec couvercle
Cacerola alta con tapa

art.	Ø cm.	h.	lt.
12509-12	12	6	0,7



Saucepan, oval, Stoneware
Casseruola ovale
Kasserolle, oval
Casserole, ovale
Cacerola, oval

art.	cm.	h.
41210-03	13x8,2	3,9



Saucepan, Stoneware
Tegamimo
Pfännchen
Sautoir
Fuente huevo

art.	Ø cm.	h.
41210-12	13	5
41210-13	15	5
41210-14	17	5



Saucepan, rectangular, Stoneware
Casseruola rettangolare
Kasserolle, rechteckig
Casserole, rectangulaire
Cacerola, rectangular

art.	cm.	h.
41210-05	13x8,2	3,9



Piepan, Stoneware
Tortiera
Kuchenform
Ramequin
Molde tarta

art.	Ø cm.	h.
41210-10	11	3,9



Saucepan, round, Stoneware
Casseruola tonda
Kasserolle, rund
Casserole, ronde
Cacerola, redonda

art.	Ø cm.	h.
41210-01	13	3,9



Saucepan with lid, Stoneware
Casseruola con coperchio
Kasserolle mit Deckel
Casserole avec couvercle
Cacerola con tapa

art.	Ø cm.	h.
41210-07	11,5	5,5
41210-08	13,0	7,5

ENAMELLED CAST IRON GHISA SMALTATA

COOKWARE
PENTOLAME



Suitable for use on all cooking hobs (gas, electric, ceramic, induction) and ovens (gas, oil, coal or wood) except microwave. A perfect harmony of cast iron, enamel and high quality. Designed and constructed to absorb and spread the heat evenly. Cast iron is suitable for all cooking techniques, for soups, roasts, rice, desserts, for braise that require a long cooking and likewise ideal for meats and grilled vegetables as it enhances flavors and aromas like barbecue style. Cast iron also features non-stick. The high temperature of the pan sears the meat surface. All the flavor, water and nutritional values remain sealed in the food. When cooking in casseroles, the steam generated thanks to the special design of the cover condenses falling back into the food not only retaining flavors and aromas but providing the best protection for nutrients and contributing to a healthy diet. Cast iron is a material 100% recyclable and therefore environmentally friendly. Moreover, thanks to its ability to retain heat for a long time it allows a considerable saving of energy. With closed lid on the table, the pot will preserve the temperature for a second serving. Cast iron retains the heat but as well the cold... can be used to keep the food fresh. Stored for a short time in the refrigerator, keeps food cool during hot summer days, ideal for serving pasta or rice salads, etc. Practical and easy to clean. These cast iron pots and pans are dishwasher safe thanks to the special technology applied to their enameling method. Ergonomic knobs and handles made of cast iron and stainless steel, suitable for use on all heat sources and ovens except microwave. Be careful, they heat up during cooking, it is recommended to handle with a dry thick cloth.

Idonee all'uso su tutte le fonti di cottura (gas, elettriche, vetroceramica, induzione) e forni (gas, petrolio, carbone o legna) ad esclusione di microonde. Una perfetta armonia tra ghisa, smalto e alta qualità. Progettate e costruite per assorbire e diffondere il calore in modo uniforme. La ghisa è adatta a tutte le tecniche di cottura, per zuppe, arrostiti, risotti, dolci, per piatti che richiedono una lunga cottura tipo brasati e allo stesso modo ideale per carni e verdure alla griglia in quanto ne esalta sapori ed aromi in stile barbecue. La ghisa ha anche caratteristiche di antiaderenza. La temperatura elevata della padella cauterizza la superficie della carne. Tutto il sapore, l'acqua e i valori nutrizionali rimangono sigillati nel cibo. Nella cottura in casseruole, il vapore generato grazie al particolare design del coperchio si condensa ricadendo e mescolandosi nuovamente nel cibo non solo trattenendo sapori e aromi ma fornendo la miglior protezione alle sostanze nutrienti e contribuendo ad una dieta sana. La ghisa è un materiale riciclabile al 100% e quindi ecologico. Inoltre, grazie alla sua capacità di mantenere il calore per lungo tempo consente un notevole risparmio di energia permettendo di cuocere a fuoco basso. Anche a tavola mantengono in cibi in temperatura. La ghisa mantiene però il caldo come pure il freddo... può essere usata per mantenere il cibo fresco. Riposta per un breve periodo in frigorifero, mantiene il cibo fresco nelle calde giornate estive e ideale per servire insalate di pasta, riso, farro, ecc., ecc. Pratica e facile da pulire. Queste casseruole e padelle in ghisa sono lavabili in lavastoviglie, per merito della speciale tecnologia applicata al metodo di smaltatura. Manicatura e pomoli dal design ergonomico sono in ghisa e inox. Durante la cottura si raccomanda di maneggiare con un panno consistente e asciutto per evitare di scottarsi.



Saucepot round with lid

Casseruola tonda con coperchio
Fleischtopf, rund mit Deckel
Brasière avec couvercle
Cacerola redonda con tapa

art.	Ø cm.	lt.	col.
44201R10	10	0,35	●
44201V10	10	0,35	●
44201B10	10	0,35	●
44201O10	10	0,35	●
44201N10	10	0,35	●

Portion: – Porzioni: 1



Saucepot round with lid

Casseruola tonda con coperchio
Fleischtopf, rund mit Deckel
Brasière avec couvercle
Cacerola redonda con tapa

art.	Ø cm.	lt.	col.
44201R12	12	0,55	●
44201V12	12	0,55	●
44201B12	12	0,55	●
44201O12	12	0,55	●
44201N12	12	0,55	●

Portion: – Porzioni: 1



Oval saucepan with lid

Casseruola ovale con coperchio
Ovaler Bratentopf mit Deckel
Casserole ovale avec couvercle
Cacerola oval con tapa

art.	cm.	col.
44202R12	12x9x6	●
44202V12	12x9x6	●
44202B12	12x9x6	●
44202O12	12x9x6	●
44202N12	12x9x6	●

Portion: – Porzioni: 1



Saucepot stand

Supporto casseruolina
Fleischtopf-Träger
Support pour brasière
Soporte para cacerola

art.	Ø cm.
44201-01	10



Saucepot stand

Supporto casseruolina
Fleischtopf-Träger
Support pour brasière
Soporte para cacerola

art.	Ø cm.
44201-03	10



Saucepot platter

Sottopentola
Fleischtopfbrett
Planche à casserole
Tabla para cacerola

art.	Ø cm.
44201-10	10-12



Saucepot platter

Sottopentola
Fleischtopfbrett
Planche à casserole
Tabla para cacerola

art.	cm.
44202-10	12x9



Soufflé pot with wooden platter

Coppa soufflé con piatto legno
Ramekin mit Holzbrett
Ramequin avec planche bois
Fuente soufflé con tabla madera

art.	Ø cm.	lt.
44240S08	8	0,17

Portion: – Porzioni: 1



Saucepot with lid

Casseruola alta con coperchio
Fleischtopf mit Deckel
Brasière avec couvercle
Cacerola alta con tapa

art.	Ø cm.	lt.	Por.
44201R16	16	1,0	1-2
44201R20	20	2,6	2-3
44201R24	24	4,5	4-5
44201R28	28	6,7	6-8
44201R32	32	10,0	12-16



Saucepot with lid

Casseruola alta con coperchio
Fleischtopf mit Deckel
Brasière avec couvercle
Cacerola alta con tapa

art.	Ø cm.	lt.	Por.
44201N16	16	1,0	1-2
44201N20	20	2,6	2-3
44201N24	24	4,5	4-5
44201N28	28	6,7	6-8
44201N32	32	10,0	12-16



Saucepot with glass lid

Casseruola alta coperchio vetro
Fleischtopf mit Glasdeckel
Brasière avec couvercle verre
Cacerola alta con tapa vidrio

art.	Ø cm.	lt.	Por.
44203R20	20	2,6	2-3
44203R24	24	4,5	4-5
44203R28	28	6,7	6-8



Oval saucepan with lid

Casseruola ovale con coperchio
Ovaler Bratentopf mit Deckel
Casserole ovale avec couvercle
Cacerola oval con tapa

art.	Ø cm.	lt.	Por.
44202R25	25	3,3	4
44202R27	27	4,0	4-6
44202R29	29	4,8	6



Oval saucepan with lid

Casseruola ovale con coperchio
Ovaler Bratentopf mit Deckel
Casserole ovale avec couvercle
Cacerola oval con tapa

art.	Ø cm.	lt.	Por.
44202N25	25	3,3	4
44202N27	27	4,0	4-6
44202N29	29	4,8	6



Casserole pot with glass lid

Casseruola bassa coperchio vetro
Bratentopf mit Glasdeckel
Sautoir avec couvercle verre
Cacerola baja con tapa vidrio

art.	Ø cm.	lt.	Por.
44204R24	24	2,4	4
44204R28	28	3,4	4-6



Saucepan with glass lid

Casseruola alta con coperchio vetro
Stielkasserolle, hoch mit Glasdeckel
Casserole haute avec couvercle verre
Cazo recto alto con tapa vidrio

art.	Ø cm.	lt.	Por.
44239R16	16	1,0	1-2



Frypan

Padella
Bratpfanne
Poêle
Sartén

art.	Ø cm.	lt.	Por.
44205-16	16	0,42	1
44205-20	20	0,80	1-2



Frypan wooden handle

Padella manico legno
Bratpfanne mit Holz-Griff
Poêle manche bois
Sartén mango madera

art.	Ø cm.	lt.	Por.
44205-24	24	1,5	4
44205-28	28	2,5	4-6



Wok pan

Wok
Wok-Pfanne
Poêle chinoise
Wok

art.	Ø cm.	lt.	Por.
44247-38	38	5,3	4



Platter with magnetic feature

Sottopentola magnetico
Untersetzer, magnetisch
Sous-plat magnétique
Posavasos magnético

art.	Ø cm.
44207-16	16
44207-20	20
44207-24	24
44207-28	28



Grill pan

Padella grill
Grill-Pfanne
Poêle grill
Sartén grill

art.	cm.	lt.	Por.
44209R26	26x26	2,2	4
44209R32	26x32	2,6	6



Grill pan

Padella grill
Grill-Pfanne
Poêle grill
Sartén grill

art.	cm.	lt.	Por.
44210-26	26x26	2,20	4
44210-32	26x32	2,75	6



Silicone sleeves

Coprimaniglie silicone
Silikon-Griffhüllen
Revêtement en silicone pour poignées
Cubre asas de silicona

art.	col.
44208G00	●
44208R00	●



Grill pan with wooden service stand

Padella grill con tagliere a servire legno
Grill-Pfanne mit Service-Holzbrett
Poêle grill avec support à servir bois
Sartén grill con tabla madera

art.	cm.	lt.	Por.
44210S26	26x26	2,20	4
44210S32	26x32	2,75	6



Grill pan

Padella grill
Grill-Pfanne
Poêle grill
Sartén grill

art.	cm.	lt.	Por.
44210-42	31x42	4,5	8



Grill pan with wooden service stand
Padella grill con tagliere a servire legno
Grill-Pfanne mit Service-Holzbrett
Poêle grill avec support à servir bois
Sartén grill con tabla madera

art.	cm.	lt.	Por.
44210S42	31x42	4,5	8



Bake roasting dish
Tegame rettangolare
Pfanne, rechteckig
Plat rectangulaire
Rustidera

art.	cm.	Por.
44218R30	22x30	6-8
44218R40	26x40	8-12



Terrine pot
Terrina
Pasteten-Pfanne
Terrine rectangle
Fuente rectangular

art.	cm.	Por.
44219R26	8,5x26,5x6	2-4



Grill pan and wooden service stand
Padella grill con tagliere a servire legno
Grill-Pfanne mit Service-Holzbrett
Poêle grill avec plaque à servir bois
Sartén grill con tabla madera

art.	cm.	Por.
44216S16	16x16	1

Cups not included. – Ciotoline non incluse.



Grill pan with wooden platter
Padella grill con tagliere legno
Grill-Pfanne mit Holzbrett
Poêle grill avec plaque bois
Sartén grill con tabla madera

art.	cm.	Por.
44215S16	16x16	1

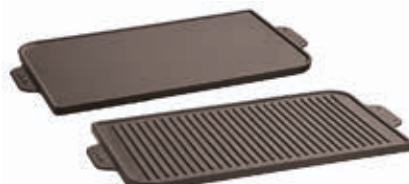

Griddle plate, dual side, reversible
Griglia reversibile
Grill-Platte, zweiseitig, reversible
Gril rectangle, reversible
Parrilla reversible

art.	cm.	Por.
44217-45	26x47	6-8



Grill pan
Bistecchiera
Grill-Pfanne
Poêle grill
Sartén grill

art.	Ø cm.	lt.	Por.
44212-30	30	2,35	4-6



Grill pan
Bistecchiera
Grill-Pfanne
Poêle grill
Sartén grill

art.	cm.	Por.
44213-24	24x24	1-2
44213-36	21x36	2-4



Grill pan
Bistecchiera
Grill-Pfanne
Poêle grill
Sartén grill

art.	Ø cm.	Por.
44214-25	25	2-3



Fish plate with wooden platter
Piatto pesce con tagliere legno
Fischplatte mit Holzbrett
Plat à poisson avec planche bois
Fuente pescado con tabla madera

art.	cm.	Por.
44220S24	15x24	1-2



Fish plate with wooden platter
Piatto pesce con tagliere legno
Fischplatte mit Holzbrett
Plat à poisson avec planche bois
Fuente pescado con tabla madera

art.	cm.	Por.
44221S30	15,5x29,5	1-2



Pizza pan
Piatto pizza
Pizza-Platte
Plat à pizza
Fuente para pizza

art.	Ø cm.	Por.
44222-20	20	1
44222-28	28	1



Pizza pan with wooden platter
Piatto pizza con tagliere legno
Pizza-Platte mit Holzbrett
Plat à pizza avec planche bois
Fuente para pizza con tabla madera

art.	Ø cm.	Por.
44222S20	20	1
44222S28	28	1



Griddle plate, dual side, reversible
Griglia reversibile
Grill-Platte, zweiseitig, reversibel
Grill rectangle, reversible
Parrilla reversible

art.	cm.	Por.
44224-22	22x15	1-2



Grill plate and wooden platter
Griglia reversibile con tagliere legno
Grill-Platte mit Service-Holzbrett
Grill avec plaque à servir bois
Parrilla con tabla madera

art.	cm.	Por.
44224S22	22x15	1-2



Table barbecue
Barbecue da tavola
Tischgrillplatte
Barbecue de table
Parrilla de mesa

art.	cm.	Por.
44225-22	22x15	1-2

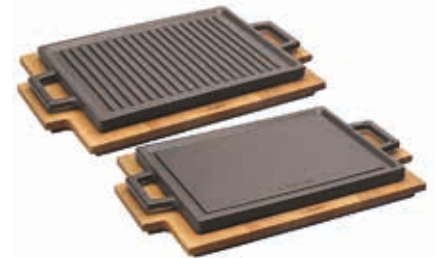

Griddle with wooden platter
Griglia con tagliere legno
Grill-Platte mit Holzbrett
Grill rectangle avec planche bois
Parrilla con tabla madera

art.	cm.	Por.
44226S30	22x30	2-3



Table barbecue
Barbecue da tavola
Tischgrillplatte
Barbecue de table
Parrilla de mesa

art.	cm.	Por.
44227-30	22x30	2-3



Fajita plate with wooden platter
Piatto fajita con tagliere legno
Fajitaplatte mit Holzbrett
Plat à fajitas avec planche bois
Fuente fajitas con tabla madera

art.	cm.	Por.
44228S23	17x23	1



Fajita plate with wooden platter

Piatto fajita con tagliere legno
Fajitaplatte mit Holzbrett
Plat à fajitas avec planche bois
Fuente fajitas con tabla madera

art.	cm.	Por.
44229S20	10x20	1



Oval plate with wooden platter

Piatto ovale con tagliere legno
Ovalplatte mit Holzbrett
Plat oval avec planche bois
Fuente ovale con tabla madera

art.	cm.	Por.
44230S10	15x10x2,5	1
44230S14	21x14x2,5	1-2



Oval plate with wooden platter

Piatto ovale con tagliere legno
Ovalplatte mit Holzbrett
Plat oval avec planche bois
Fuente ovale con tabla madera

art.	cm.	Por.
44231-14	21x14x2,5	1-2

Cups not included. – Ciotoline non incluse.



Round plate with wooden platter

Piatto tondo con tagliere legno
Platte mit Holzbrett, rund
Plat rond avec planche bois
Fuente redonda con tabla madera

art.	Ø cm.	Por.
44232S12	12	1
44232S16	16	1-2
44232S20	20	2-3



Round plate with wooden platter

Piatto tondo con tagliere legno
Platte mit Holzbrett, rund
Plat rond avec planche bois
Fuente redonda con tabla madera

art.	Ø cm.	lt.	Por.
44233-16	16	0,46	1-2
44233-20	20	0,74	3-4

Cups not included. – Ciotoline non incluse.



Round pan

Padella tonda
Pfanne, rund
Poêle ronde
Sartén grill redonda

art.	Ø cm.	Por.
44234-12	12	1
44234-16	16	1-2



Pan and wooden platter

Padella con tagliere legno
Pfanne mit Holzbrett
Poêle avec plache bois
Sartén grill con tabla madera

art.	Ø cm.	lt.	Por.
44234S12	12	0,24	1
44234S16	16	0,45	1-2



Pan and wooden platter

Padella con tagliere legno
Pfanne mit Holzbrett
Poêle avec plache bois
Sartén grill con tabla madera

art.	Ø cm.	lt.	Por.
44235-16	16	0,45	1-2

Cups not included. – Ciotoline non incluse.



Rectangular pan with wooden service stand

Tegame con tagliere a servire legno
Pfanne mit Service-Holzbrett
Poêle avec support à servir bois
Sartén con tabla madera

art.	cm.	Por.
44237S15	12x15	1-2



Rectangular pan with wooden service stand

Tegame con tagliere a servire legno
Pfanne mit Service-Holzbrett
Poêle avec support à servir bois
Sartén con tabla madera

art.	cm.	Por.
44238-15	12x15	1-2

Cups not included. – Ciotoline non incluse.



Tortillas cup

Ciotola tortillas
Tortillas-Schale
Coupe-tortillas
Copa tortillas

art.	Ø cm.
44241-19	19

W



Soufflé pot, enameled cast iron
Coppa soufflè, ghisa smaltata
Ramekin, emailiertes Gusseisen
Ramequin, fonte émaillée
Fuente soufflè, hierro fundido esmaltado

art.	Ø cm.	lt.	Por.
44240-08	8	0,15	1



PR

Sauce bowl
Coppa salsa
Saucentasse
Bol à sauce
Copa para salsa

art.	Ø cm.	h.
44242-00	6	2,7



MF

Sauce bowl
Coppa salsa
Saucentasse
Bol à sauce
Copa para salsa

art.	Ø cm.	h.
44243-00	7,1	3,5



Oval plate with wooden platter
Piatto con tagliere legno
Ovalplatte mit Holzbrett
Plat oval avec planche bois
Fuente ovale con tabla madera

art.	cm.	lt.	Por.
44223S19	12,5x19	0,23	1



Griddle plate, reversible with wooden platter
Griglia reversibile con tagliere legno
Grill-Platte, reversible mit Holzbrett
Gril reversible avec planche bois
Plancha grill reversible con tabla madera

art.	Ø cm.	Por.
44236S28	28	4
44236S34	34	6



Service dish with wooden stand
Piatto servire con tagliere legno
Servierplatte mit Holzbrett
Plat à servir avec support en bois
Plato para servir con tabla madera

art.	cm.	Por.
44245S32	32x20	1



Service dish with porcelain surface
Tagliere legno con superficie porcellanata
Servierplatte mit Porzellan-Oberfläche
Plat à servir avec surface en porcelaine
Tabla con superficie porcelana

art.	cm.	Por.
44249S30	20x30x2,5	1-2
44249S35	25x35x2,5	1-2



Service dish with porcelain surface
Tagliere legno con superficie porcellanata
Servierplatte mit Porzellan-Oberfläche
Plat à servir avec surface en porcelaine
Tabla con superficie porcelana

art.	Ø cm.	Por.
44250S30	30	1-2
44250S35	35	1-2



Plate warmer, beechwood & stainless steel
Rechaud, faggio/inox
Rechaud, Buche u. Edelstahl
Réchaud, hêtre/inox
Réchaud, madera/inox

art.	cm.
44251-01	16x16x2,5
44251-03	36x20x2,5



Service dish with porcelain surface
Tagliere con superficie porcellanata
Servierplatte mit Porzellan-Oberfläche
Plat à servir avec surface en porcelaine
Tabla con superficie porcelana

art.	cm.	Por.
44255-10	39,5x25x2,5	1

Incl. casserole Ø 10 cm with lid. Sauce cups not included. – Incl. casseruola c/cop. ø 10 cm. Coppette salsa escluse.



Service dish with porcelain surface
Tagliere con superficie porcellanata
Servierplatte mit Porzellan-Oberfläche
Plat à servir avec surface en porcelaine
Tabla con superficie porcelana

art.	cm.	Por.
44255-12	39,5x25x2,5	1

Incl. oval casserole 12 cm with lid. Sauce cups not included. – Incl. casseruola ovale c/cop. 12 cm. Coppette salsa escluse.



Service dish with porcelain surface
Tagliere con superficie porcellanata
Servierplatte mit Porzellan-Oberfläche
Plat à servir avec surface en porcelaine
Tabla con superficie porcelana

art.	cm.	Por.
44255-14	39,5x25x2,5	1
44255-16	39,5x25x2,5	1-2

Incl. skillet ø 12/16 cm. Sauce cups not included. Incl. padella ø 12/16 cm. Coppette salsa escluse.



Service dish with porcelain surface
Tagliere con superficie porcellanata
Servierplatte mit Porzellan-Oberfläche
Plat à servir avec surface en porcelaine
Tabla con superficie porcelana

art. cm. Por.
44255-15 39,5x25x2,5 1-2

Incl. dish 12x15 cm. Sauce cups not included.
Incl. tegamino 12x15 cm. Coppette salsa escluse.



Service dish with porcelain surface
Tagliere con superficie porcellanata
Servierplatte mit Porzellan-Oberfläche
Plat à servir avec surface en porcelaine
Tabla con superficie porcelana

art. cm. Por.
44255-21 39,5x25x2,5 1-2

Incl. dish 21x14 cm. Sauce cups not included.
Incl. tegamino 21x14 cm. Coppette salsa escluse.



Service dish with porcelain surface
Tagliere con superficie porcellanata
Servierplatte mit Porzellan-Oberfläche
Plat à servir avec surface en porcelaine
Tabla con superficie porcelana

art. cm. Por.
44255-22 39,5x25x2,5 1-2

Incl. pan ø16 cm. Sauce cups not included.
Incl. tegamino ø 16 cm. Coppette salsa escluse.



Plate pig with wooden platter
Piatto maiale con tagliere legno
Platte Schwein mit Holzbrett
Plat porc avec planche bois
Plato cerdo con tabla madera

art. cm. lt. Por.
44220S32 32,5x17,5 0,38 1-2



Plate fish with wooden platter
Piatto pesce con tagliere legno
Platte Fisch mit Holzbrett
Plat poisson avec planche bois
Plato pescado con tabla madera

art. cm. lt. Por.
44220S38 24,5x16,5 0,12 1



Pan with wooden platter
Tegame con tagliere legno
Pfanne mit Holzbrett
Poêle avec plache bois
Paellera con tabla madera

art. Ø cm. cm. lt. Por.
44247S16 16 23,5x18,5 0,44 1-2



Service dish with porcelain surface
Tagliere con superficie porcellanata
Servierplatte mit Porzellan-Oberfläche
Plat à servir avec surface en porcelaine
Tabla con superficie porcelana

art. cm. lt. Por.
44255-08 39,5x28x4,3 0,17 1

Incl. dish 16x25 cm. Sauce cups not included.
Incl. piatto 16x25cm. Coppette salsa escluse.



Service dish with wooden stand
Piatto servire con tagliere legno
Servierplatte mit Holzbrett
Plat à servir avec support en bois
Plato para servir con tabla madera

art. cm. Por.
44244S30 30x15 1-2
44244S36 36x24 4-6



Hot pot with wooden stand
Casseruola con tagliere legno
Schüssel mit Holzbrett
Bol avec support en bois
Bol con tabla madera

art. Ø cm. h. lt. Por.
44246S11 11 4 0,21 1
44246S14 14 4 0,32 1
44246S17 17 4 0,59 1



Platter with porcelain surface
Tagliere con superficie porcellanata
Platte mit Porzellan-Oberfläche
Plat à servir avec surface en porcelaine
Tabla con superficie porcelana

art. cm. Por.
44248S60 60x15x2,5 4



Platter with porcelain surface
Tagliere con superficie porcellanata
Platte mit Porzellan-Oberfläche
Plat à servir avec surface en porcelaine
Tabla con superficie porcelana

art. Ø cm. h. Por.
44254-30 31 2,5 1

Wood: – Legno : Iroko



Wooden service platter

Tagliere legno
Holzbrett
Planche à Servir en bois
Tabla madera

art. Por.

44258-60 4-6

Wood: – Legno : Iroko



Wooden service platter

Tagliere legno
Holzbrett
Planche à Servir en bois
Tabla madera

art. Ø cm. h. Por.

44259-29 29 2,5 1-2

Wood: – Legno : Iroko



Wooden service platter

Tagliere legno
Holzbrett
Planche à Servir en bois
Tabla madera

art. cm. Por.

44264-35 25x35x1,8 1-2

Wood: – Legno : Iroko



Wooden service platter

Tagliere legno
Holzbrett
Planche à Servir en bois
Tabla madera

art. cm. Por.

44265-35 25x35x1,8 1-2

Wood: – Legno : Iroko



Wooden service platter

Tagliere legno
Holzbrett
Planche à Servir en bois
Tabla madera

art. cm. Por.

44260-30 30x43x1,8 1-2

44260-34 34x47x1,8 2

Wood: – Legno : Iroko



Wooden service platter

Tagliere legno
Holzbrett
Planche à Servir en bois
Tabla madera

art. cm. Por.

44261-46 34x46x2,5 2

Wood: – Legno : Iroko



Wooden service platter

Tagliere legno
Holzbrett
Planche à Servir en bois
Tabla madera

art. cm. Por.

44262-42 26x42x2,5 1-2

Wood: – Legno : Iroko



Wooden service platter

Tagliere legno
Holzbrett
Planche à Servir en bois
Tabla madera

art. cm. Por.

44263-36 14x36x3,5 1-2

Wood: – Legno : Iroko



Single source pot wooden platter

Porta coppetta singolo
Schale-Träger Einzel
Support à bol simple
Soporte copa individual

art. Ø cm. cm.

44256-01 5,5 8x11x1,8

Beechwood. Without cup.
Legno di faggio. Senza Ciotoline.



Twice source pot wooden platter

Porta coppette doppio
Schale-Träger doppel
Support à bol double
Soporte copa doble

art. Ø cm. cm.

44256-02 5,5 8x20x1,8

Beechwood. Without cups.
Legno di faggio. Senza Ciotoline.



Triple source pot wooden platter

Porta coppette triplo
Schale-Träger dreifach
Support à bol triple
Soporte copa triple

art. Ø cm. cm.

44256-03 5,5 8x28x1,8

Beechwood. Without cups.
Legno di faggio. Senza Ciotoline.



Quartet source pot wooden platter

Porta coppette quadruplo
Schale-Träger quad
Support à bol quadruple
Soporte copa cuatro veces

art. Ø cm. cm.

44256-04 5,5 8x36x1,8

Beechwood. Without cups.
Legno di faggio. Senza Ciotoline.

OVEN COOKING DISHES PIROFILE FORNO

PORCELAIN
PORCELLANA



Only use in the oven or microwave oven, do not place them on direct flame.

Per uso in forni tradizionali e microonde, non mettere le porcellane a diretto contatto con la fiamma.



Oval dish, fluted

Pirofila ovale cordonata
Schale, oval, gerippt
Plat ovale, cannelé

Fuente oval borderizata

art.	cm.
44371-24	24x14x4
44371-28	28x16x4,5
44371-32	32,5x18x5
44371-36	36,5x19,5x5
44371-40	41x23x5,5
44371-44	44x26,5x5,7
44371-48	48x28,5x6,5



Round dish, fluted

Pirofila rotonda cordonata
Schale, rund, gerippt
Plat rond, cannelé

Fuente redonda borderizata

art.	Ø cm.
44372-26	26,5
44372-32	32,0
44372-36	36,0
44372-40	40,0



Rectangular dish, fluted

Pirofila rettangolare cordonata
Schale, rechteckig, gerippt
Plat rectangulaire, cannelé

Fuente rectangular borderizata

art.	cm.
44374-22	22x16x6
44374-25	25x20x7
44374-32	32x22x6
44374-36	36x24x6
44374-40	40x26x6
44374-44	44x32x6



Oval dish, high, fluted

Pirofila ovale cordonata, alta
Schale, oval, gerippt
Plat oval, cannelé

Fuente oval borderizata, alta

art.	cm.
44389-32	32x22x8,5



Rectangular dish, low, fluted

Rettangolare cordonata, bassa
Schale, rechteckig, flach, gerippt
Plat rectangulaire, cannelé

Fuente rect. borderizata, baja

art.	cm.
44376-40	40x30x4



Square dish, fluted

Pirofila quadra cordonata
Schale, quadratisch, gerippt
Plat carré, cannelé

Fuente cuadrada borderizata

art.	cm.
44375-25	25x25x6



Egg dish, fluted

Tegamino cordonato
Schale, gerippt
Plat à oeufs, cannelé

Fuente huevo borderizata

art.	cm.
44394-18	18x21,0
44394-21	21x24,5



Crepe broulée bowl

Coppetta creme broulée
Crème broulée Schale
Coupelle broulée à crème

Bol creme broulée

art.	Ø cm.	h.
44391-12	11,6	3



Egg dish, high, fluted

Tegamino fondo, cordonato
Schale, tief, gerippt
Plat oeuf, creux, cannelé

Fuente huevo borderizata, alta

art.	cm.
44395-18	18x20



Soup bowl with cover

Casseruola con coperchio
Kasserolle mit Deckel
Casserole avec couvercle
Cacerola con tapa

art.	cm.	lt.
44397-18	14x18	0,5



Ramekin, fluted

Soufflé cordonato
Ramekin, gerippt
Ramequin, cannelé

Fuente soufflé borderizata

art.	Ø cm.	h.
44390-07	7	4,0
44390-09	9	4,5
44390-11	11	6,0



Ramekin, fluted

Soufflé cordonato
Ramekin, gerippt
Ramequin, cannelé

Fuente soufflé borderizata

art.	Ø cm.	h.
44390-15	15	5,0
44390-18	18	7,5
44390-23	23	8,0

GN FOOD PANS CONTENITORI GN

STAINLESS STEEL, ALUMINUM, POLYCARBONATE, POLYPROPYLENE, MELAMINE AND PORCELAIN
INOX, ALLUMINIO, POLICARBONATO, POLIPROPILENE, MELAMINA E PORCELLANA



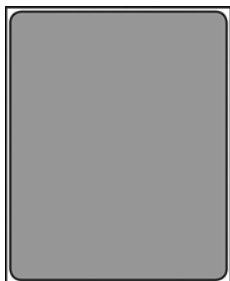

GN-containers

GN bacinelle
GN-Behälter
GN bacs
GN cubetas



art.	GN	dim. mm.	h. mm.	lt.
14101-02	2/1	650x530	20	-
14101-04	2/1	650x530	40	-
14101-06	2/1	650x530	65	19
14101-10	2/1	650x530	100	31
14101-15	2/1	650x530	150	46
14101-20	2/1	650x530	200	56



art.	GN	dim. mm.	h. mm.	lt.
14102-02	1/1	530x325	20	-
14102-04	1/1	530x325	40	-
14102-06	1/1	530x325	65	9
14102-10	1/1	530x325	100	14
14102-15	1/1	530x325	150	21
14102-20	1/1	530x325	200	28



art.	GN	dim. mm.	h. mm.	lt.
14103-02	2/3	353x320	20	-
14103-04	2/3	353x320	40	-
14103-06	2/3	353x320	65	5,5
14103-10	2/3	353x320	100	9,0
14103-15	2/3	353x320	150	13,0
14103-20	2/3	353x320	200	18,0

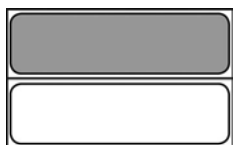

art.	GN	dim. mm.	h. mm.	lt.
14104-06	2/4	162x530	65	4,0
14104-10	2/4	162x530	100	5,6
14104-15	2/4	162x530	150	8,7



art.	GN	dim. mm.	h. mm.	lt.
14105-02	1/2	325x265	20	-
14105-04	1/2	325x265	40	-
14105-06	1/2	325x265	65	4,0
14105-10	1/2	325x265	100	6,5
14105-15	1/2	325x265	150	9,5
14105-20	1/2	325x265	200	12,5

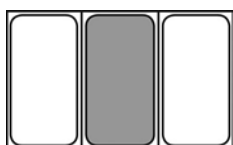

art.	GN	dim. mm.	h. mm.	lt.
14107-06	1/3	325x180	65	2,5
14107-10	1/3	325x180	100	4,0
14107-15	1/3	325x180	150	5,7
14107-20	1/3	325x180	200	7,8



art.	GN	dim. mm.	h. mm.	lt.
14108-06	1/4	265x160	65	1,8
14108-10	1/4	265x160	100	2,8
14108-15	1/4	265x160	150	4,0
14108-20	1/4	265x160	200	5,5



art.	GN	dim. mm.	h. mm.	lt.
14109-06	1/6	176x160	65	1,0
14109-10	1/6	176x160	100	1,6
14109-15	1/6	176x160	150	2,4
14109-20	1/6	176x160	200	3,4



art.	GN	dim. mm.	h. mm.	lt.
14110-06	1/9	176x110	65	0,6
14110-10	1/9	176x110	100	1,0



GN-containers, fixed handles

GN bacinelle, maniglie fisse
GN-Behälter mit festen Griffen

GN bacs, anses fixes
GN cubetas, asas fijas

art.	GN	dim. mm.	h. mm.	lt.
14112-10	1/1	530x325	100	14,0
14112-15	1/1	530x325	150	21,0
14112-20	1/1	530x325	200	28,0





art.	GN	dim. mm.	h. mm.	lt.
14115-10	1/2	325x265	100	6,5
14115-15	1/2	325x265	150	9,5
14115-20	1/2	325x265	200	12,5

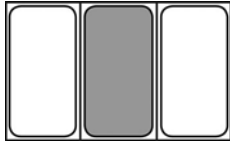

art.	GN	dim. mm.	h. mm.	lt.
14117-10	1/3	325x180	100	4,0
14117-15	1/3	325x180	150	5,7
14117-20	1/3	325x180	200	7,8



art.	GN	dim. mm.	h. mm.	lt.
14118-10	1/4	265x160	100	2,8
14118-15	1/4	265x160	150	4,0
14118-20	1/4	265x160	200	5,5



art.	GN	dim. mm.	h. mm.	lt.
14119-10	1/6	176x160	100	1,6
14119-15	1/6	176x160	150	2,4



GN-containers, internal handles
GN bacinelle, maniglie interne
GN-Behälter mit Innen Griffen
GN bacs, anses internes
GN cubetas, asas internas



art.	GN	dim. mm.	h. mm.	lt.
14142-10	1/1	530x325	100	14,0
14142-15	1/1	530x325	150	21,0
14142-20	1/1	530x325	200	28,0



art.	GN	dim. mm.	h. mm.	lt.
14145-10	1/2	325x265	100	6,5
14145-15	1/2	325x265	150	9,5
14145-20	1/2	325x265	200	12,5

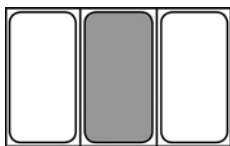

art.	GN	dim. mm.	h. mm.	lt.
14147-10	1/3	325x180	100	4,0
14147-15	1/3	325x180	150	5,7
14147-20	1/3	325x180	200	7,8



art.	GN	dim. mm.	h. mm.	lt.
14148-10	1/4	265x160	100	2,8
14148-15	1/4	265x160	150	4,0
14148-20	1/4	265x160	200	5,5

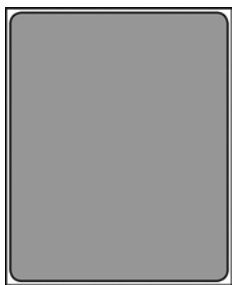

GN-containers, falling handles
GN bacinelle, maniglie rientranti
GN-Behälter mit versenkbaren Griffen
GN bacs, anses escamotables
GN cubetas, asas móviles



art.	GN	dim. mm.	h. mm.	lt.
14151-10	2/1	650x530	100	31,0
14151-15	2/1	650x530	150	46,0
14151-20	2/1	650x530	200	56,0



art.	GN	dim. mm.	h. mm.	lt.
14152-06	1/1	530x325	65	9,0
14152-10	1/1	530x325	100	14,0
14152-15	1/1	530x325	150	21,0
14152-20	1/1	530x325	200	28,0



art.	GN	dim. mm.	h. mm.	lt.
14155-10	1/2	325x265	100	6,5
14155-15	1/2	325x265	150	9,5
14155-20	1/2	325x265	200	12,5

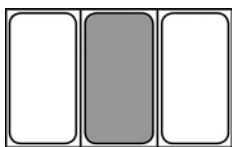

art.	GN	dim. mm.	h. mm.	lt.
14157-10	1/3	325x180	100	4,0
14157-15	1/3	325x180	150	5,7
14157-20	1/3	325x180	200	7,8



art.	GN	dim. mm.	h. mm.	lt.
14158-10	1/4	265x160	100	2,8
14158-15	1/4	265x160	150	4,0
14158-20	1/4	265x160	200	5,5



art.	GN	dim. mm.	h. mm.	lt.
14159-10	1/6	176x160	100	1,6
14159-15	1/6	176x160	150	2,4
14159-20	1/6	176x160	200	3,4



GN-containers non stick coated
GN bacinelle antiaderenti
GN-Behälter mit Antihafbeschichtung
GN-bacs avec revêtement anti-adhésif
GN-cubetas con cobertura antiadherente



art.	GN	dim. mm.	h. mm.
14162-02	1/1	530x325	20
14162-04	1/1	530x325	40
14162-06	1/1	530x325	65



art.	GN	dim. mm.	h. mm.
14165-02	1/2	325x265	20
14165-04	1/2	325x265	40
14165-06	1/2	325x265	65

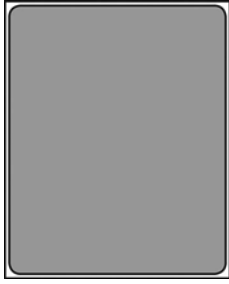

Perforated GN-containers

GN bacinelle forate
Gelochte GN-Behälter
GN bacs perforés
GN cubetas perforados



art.	GN	dim. mm.	h. mm.
14201-02	2/1	650x530	20
14201-04	2/1	650x530	40
14201-06	2/1	650x530	65
14201-10	2/1	650x530	100
14201-15	2/1	650x530	150
14201-20	2/1	650x530	200

Containers depth mm 20 and 40 only bottom perforated. – Bacinelle profondità mm 20 e 40 forate solo sul fondo.



art.	GN	dim. mm.	h. mm.
14202-02	1/1	530x325	20
14202-04	1/1	530x325	40
14202-06	1/1	530x325	65
14202-10	1/1	530x325	100
14202-15	1/1	530x325	150
14202-20	1/1	530x325	200

Containers depth mm 20 and 40 only bottom perforated. – Bacinelle profondità mm 20 e 40 forate solo sul fondo.

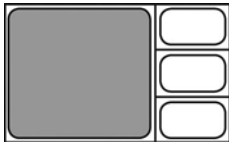

art.	GN	dim. mm.	h. mm.
14203-06	2/3	353x320	65
14203-10	2/3	353x320	100
14203-15	2/3	353x320	150
14203-20	2/3	353x320	200



art.	GN	dim. mm.	h. mm.
14205-02	1/2	325x265	20
14205-04	1/2	325x265	40
14205-06	1/2	325x265	65
14205-10	1/2	325x265	100
14205-15	1/2	325x265	150
14205-20	1/2	325x265	200

Containers depth mm 20 and 40 only bottom perforated. – Bacinelle profondità mm 20 e 40 forate solo sul fondo.



Perforated GN-containers, folding handles

GN bacinelle forate, maniglie snodate
Gelochte GN-Behälter mit Fallgriffen
GN bacs perforés, anses pliantes
GN cubetas perforados, asas plegables



art.	GN	dim. mm.	h. mm.
14252-06	1/1	530x325	65
14252-10	1/1	530x325	100
14252-15	1/1	530x325	150
14252-20	1/1	530x325	200



art.	GN	dim. mm.	h. mm.
14255-06	1/2	325x265	65
14255-10	1/2	325x265	100
14255-15	1/2	325x265	150
14255-20	1/2	325x265	200



GN-lids

GN coperchi
GN-Deckel
GN couvercles
GN tapas

art.	GN	dim. mm.
14502-00	1/1	530x325
14503-00	2/3	353x320
14504-00	2/4	162x530
14505-00	1/2	325x265
14507-00	1/3	325x180
14508-00	1/4	265x160
14509-00	1/6	176x160
14510-00	1/9	176x110



GN-lids with notched edge for handles

GN coperchi con spacco maniglie
GN-Deckel mit Griffen-Ausschnitt
GN couvercles avec encoche pour anses
GN tapas con orificio asas

art.	GN	dim. mm.
14512-00	1/1	530x325
14515-00	1/2	325x265
14517-00	1/3	325x180
14518-00	1/4	265x160
14519-00	1/6	176x160



GN-lids with notched edge for ladle

GN coperchi con spacco mestolo
GN-Deckel mit Löffel-Ausschnitt
GN couvercles avec encoche pour louche
GN tapas con orificio cacillo

art.	GN	dim. mm.
14522-00	1/1	530x325
14523-00	2/3	353x320
14525-00	1/2	325x265
14527-00	1/3	325x180
14528-00	1/4	265x160
14529-00	1/6	176x160



GN-lids with notched edge for handles/ladle

GN coperchi con spacco maniglie/mestolo
GN-Deckel mit Griffen u. Löffel-Ausschnitt
GN couvercles avec encoche pour anses/louche
GN tapas con orificio asas/cacillo

art.	GN	dim. mm.
14532-00	1/1	530x325
14535-00	1/2	325x265
14537-00	1/3	325x180
14538-00	1/4	265x160
14539-00	1/6	176x160



GN-lids with silicone seal

GN coperchi con guarnizione silicone
GN-Deckel mit Silikondichtung
GN couvercles avec joint silicone
GN tapas con junta de silicona

art.	GN	dim. mm.
14542-00	1/1	530x325
14543-00	2/3	353x320
14545-00	1/2	325x265
14547-00	1/3	325x180
14548-00	1/4	265x160
14549-00	1/6	176x160





GN-lids with notched edge for handles and seal
GN coperchi con spacco maniglie e guarnizione
GN-Deckel mit Griffen-Ausschnitt u. Silikondichtung
GN couvercles avec encoche pour anses et joint
GN tapas con orificio asas y junta



art.	GN	dim. mm.
14552-00	1/1	530x325
14555-00	1/2	325x265

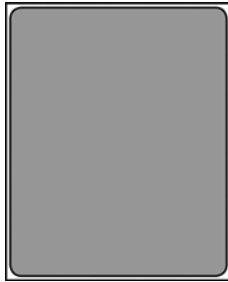

GN-baking sheets

GN-teglie
GN-Backbleche
GN-plaques
GN-bandejas



art.	GN	dim. mm.	h. mm.
14301-02	2/1	650x530	20
14301-04	2/1	650x530	40
14301-06	2/1	650x530	65



art.	GN	dim. mm.	h. mm.
14302-02	1/1	530x325	20
14302-04	1/1	530x325	40
14302-06	1/1	530x325	65

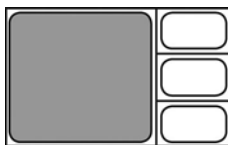

art.	GN	dim. mm.	h. mm.
14303-02	2/3	353x320	20
14303-04	2/3	353x320	40
14303-06	2/3	353x320	65



art.	GN	dim. mm.	h. mm.
14305-02	1/2	325x265	20
14305-04	1/2	325x265	40
14305-06	1/2	325x265	65



GN-baking sheets non stick coated

GN-teglie con rivestimento antiaderente
GN-Backbleche mit Antihafbeschichtung
GN-plaques avec revêtement anti-adhésif
GN-bandejas con cobertura antiadherente



art.	GN	dim. mm.	h. mm.
14362-02	1/1	530x325	20
14362-04	1/1	530x325	40
14362-06	1/1	530x325	65



art.	GN	dim. mm.	h. mm.
14365-02	1/2	325x265	20
14365-04	1/2	325x265	40
14365-06	1/2	325x265	65



GN-baking sheets, ALUMINUM

GN-teglie, ALLUMINIO
GN-Backbleche, ALUMINIUM
GN-plaques, ALUMINIUM
GN-bandejas, ALUMINIO



art.	GN	dim. mm.	h. mm.
16302-02	1/1	530x325	20
16302-04	1/1	530x325	40
16302-06	1/1	530x325	65



art.	GN	dim. mm.	h. mm.
16303-02	2/3	353x320	20
16303-04	2/3	353x320	40
16303-06	2/3	353x320	65



art.	GN	dim. mm.	h. mm.
16305-02	1/2	325x265	20
16305-04	1/2	325x265	40
16305-06	1/2	325x265	65



art.	GN	dim. mm.	h. mm.
16362-02	1/1	530x325	20
16362-04	1/1	530x325	40
16362-06	1/1	530x325	65

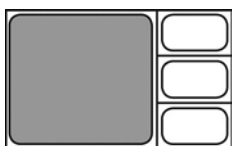

art.	GN	dim. mm.	h. mm.
16363-02	2/3	353x320	20
16363-04	2/3	353x320	40
16363-06	2/3	353x320	65



art.	GN	dim. mm.	h. mm.
16365-02	1/2	325x265	20
16365-04	1/2	325x265	40
16365-06	1/2	325x265	65



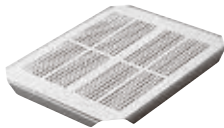

Drainer plate
Falso fondo forato
Abtropfplatte
Plateau double fond perforé
Fondo perforado

art.	GN
14402-00	1/1
14405-00	1/2
14407-00	1/3



Adaptor bar
Separatore
StegeAdapter/Zwischensteg
Barrette de composition
Adaptador

art.	GN	dim. mm.
14409-01	1/1	325
14409-02	2/1	530



Pan, enamelled
Teglia smaltata
Ofenblech, emalliert
Bac émaillé
Cubeta esmaltada

art.	GN	dim. mm.	h. mm.	lt.
44322-02	1/1	530x325	20	2,5
44322-04	1/1	530x325	40	5,0
44322-06	1/1	530x325	65	9,0

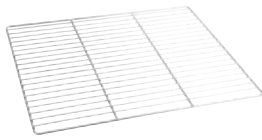

Wire grid
Griglia in filo
Gastronormrost
Grille
Rejilla

art.	GN	dim. mm.
44412-00	1/2	325x265
44423-00	2/3	353x320
44421-00	2/1	650x530



Wire grid with edge
Griglia in filo con sponda
Gastronormrost mit Seitenwand
Grille avec arrêt
Rejilla con borde

art.	GN	dim. mm.
44422-00	1/1	530x325

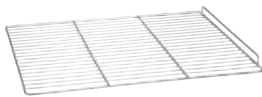

Wire grid with edge
Griglia in filo con sponda
Gastronormrost mit Seitenwand
Grille avec arrêt
Rejilla con borde

art.	GN	dim. mm.
44432-21	2/1	650x530



Fry basket
Cesta per friggere
Frittier-Korb
Panier à frire
Cesta escurrefrito

art.	GN	dim. mm.	h. mm.
11750-11	1/1	530x325	60



Grid enamelled
Griglia smaltata
Rost, emalliert
Grille émaillé
Rejilla esmaltada

art.	GN	dim. mm.
11760-11	1/1	530x325

POLYCARBONATE

POLICARBONATO

GN FOOD PANS
CONTENITORI GN



Withstands temperatures from **-40°C to +100°C**. With metric graduation.
Stackable, ideal for storage, transportation and serving display.

Termoresistenti da **-40°C a +100°C**. Con scala graduata in litri. Impilabili, sono ideali per la conservazione, trasporto ed esposizione.

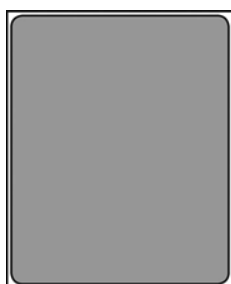

GN-containers

GN bacinelle
GN-Behälter
GN bacs
GN cubetas

art.	GN	dim. mm.	h. mm.	lt.
14561-15	2/1	650x530	150	42
14561-20	2/1	650x530	200	52



art.	GN	dim. mm.	h. mm.	lt.
14562-06	1/1	530x325	65	8,5
14562-10	1/1	530x325	100	13,0
14562-15	1/1	530x325	150	19,5
14562-20	1/1	530x325	200	26,0



art.	GN	dim. mm.	h. mm.	lt.
14565-06	1/2	325x265	65	3,9
14565-10	1/2	325x265	100	5,9
14565-15	1/2	325x265	150	8,9
14565-20	1/2	325x265	200	11,8

GN FOOD PANS CONTENITORI GN

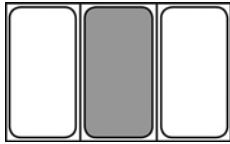

art.	GN	dim. mm.	h. mm.	lt.
14567-06	1/3	325x180	65	2,4
14567-10	1/3	325x180	100	3,6
14567-15	1/3	325x180	150	5,3
14567-20	1/3	325x180	200	7,0



art.	GN	dim. mm.	h. mm.	lt.
14568-06	1/4	265x160	65	1,7
14568-10	1/4	265x160	100	2,5
14568-15	1/4	265x160	150	3,7
14568-20	1/4	265x160	200	5,5



art.	GN	dim. mm.	h. mm.	lt.
14569-06	1/6	176x160	65	1,0
14569-10	1/6	176x160	100	1,5
14569-15	1/6	176x160	150	2,2
14569-20	1/6	176x160	200	3,4



art.	GN	dim. mm.	h. mm.	lt.
14570-06	1/9	176x110	65	0,6
14570-10	1/9	176x110	100	1,0



GN-lid without handle
GN coperchio senza traversino
GN-Deckel ohne Griff
GN couvercle sans poignée
GN tapa sin asa

art.	GN	dim. mm.
14571-00	2/1	650x530



GN-lids with handle
GN coperchi con traversino
GN-Deckel mit Griff
GN couvercles avec poignée
GN tapas con asa

art.	GN	dim. mm.
14572-00	1/1	530x325
14575-00	1/2	325x265
14577-00	1/3	325x180
14578-00	1/4	265x160
14579-00	1/6	176x160
14580-00	1/9	176x110



GN-lid with silicone seal
GN coperchio con guarnizione silicone
GN-Deckel mit Silikondichtung
GN couvercle avec joint silicone
GN tapa con junta de silicona

art.	GN	dim. mm.
14585-00	1/2	325x265



Drainer plate
Falso fondo forato
Abtropfplatte
Plateau double fond perforé
Fondo perforado

art.	GN	dim. mm.
14591-00	2/1	650x530
14592-00	1/1	530x325
14595-00	1/2	325x265
14597-00	1/3	325x180
14598-00	1/4	265x160
14599-00	1/6	176x160

POLYCARBONATE POLICARBONATO

GN FOOD PANS
CONTENITORI GN



Excellent transparency. Graduated scale according to both metric and American system. Nest for easy storage. Can be used in microwave ovens but not for prolonged times. Withstands temperatures from -40°C to +110°C. External bottom photo-etched anti-scratch. WARNING - Polycarbonate containers are not recommended for use on steam tables, avoid contact with soap. For cleaning we recommend detergents with neutral pH and, in any case less than 11.

The lids of the series 14800 polycarbonate and 14600 Tritan are interchangeable. Hermetic lids, NOT water-tight.

Eccellente trasparenza. Dotati di scala graduata sia secondo sistema metrico che americano. Impilabili, utilizzabili nel microonde ma non per tempi prolungati. Termoresistenti da -40°C a +110°C. Fondo esternamente foto-inciso anti-graffio. AVVERTENZE - I contenitori in polycarbonato non sono raccomandati per l'uso su tavole a vapore; evitare il contatto con sapone di Marsiglia. Per il lavaggio si consiglia l'utilizzo di detersivi con PH neutro o comunque inferiore a 11. I coperchi della serie 14800 polycarbonato e 14600 Tritan sono intercambiabili. Coperchi ermetici, NON a tenuta stagna.

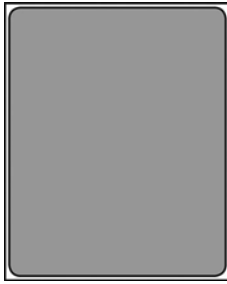

GN-containers

GN bacinelle

GN-Behälter

GN bacs

GN cubetas

art.	GN	dim. mm.	h. mm.	lt.
14801-20	2/1	650x530	200	55,5



art.	GN	dim. mm.	h. mm.	lt.
14802-06	1/1	530x325	65	9,0
14802-10	1/1	530x325	100	13,3
14802-15	1/1	530x325	150	20,0
14802-20	1/1	530x325	200	26,4



art.	GN	dim. mm.	h. mm.	lt.
14805-06	1/2	325x265	65	4,0
14805-10	1/2	325x265	100	6,1
14805-15	1/2	325x265	150	9,0
14805-20	1/2	325x265	200	11,9



art.	GN	dim. mm.	h. mm.	lt.
14807-06	1/3	325x175	65	2,5
14807-10	1/3	325x175	100	3,8
14807-15	1/3	325x175	150	5,5
14807-20	1/3	325x175	200	7,1



art.	GN	dim. mm.	h. mm.	lt.
14808-06	1/4	264x162	65	1,7
14808-10	1/4	264x162	100	2,6
14808-15	1/4	264x162	150	3,8
14808-20	1/4	264x162	200	4,8



art.	GN	dim. mm.	h. mm.	lt.
14809-06	1/6	176x162	65	1,0
14809-10	1/6	176x162	100	1,6
14809-15	1/6	176x162	150	2,3
14809-20	1/6	176x162	200	2,8



art.	GN	dim. mm.	h. mm.	lt.
14810-06	1/9	176x108	65	0,6
14810-10	1/9	176x108	100	0,9



GN-lids

GN coperchi
GN-Deckel
GN couvercles
GN tapas

art.	GN	dim. mm.
14811-00	2/1	650x530
14812-00	1/1	530x325
14815-00	1/2	325x265
14817-00	1/3	325x175
14818-00	1/4	264x162
14819-00	1/6	176x162
14820-00	1/9	176x108



GN-lids, hermetic

GN coperchi ermetici
GN-Deckel, hermetisch
GN couvercles hermétiques
GN tapas herméticas

art.	GN	dim. mm.
14832-00	1/1	530x325
14835-00	1/2	325x265
14837-00	1/3	325x175
14838-00	1/4	264x162
14839-00	1/6	176x162
14840-00	1/9	176x108



GN-lids with notched edge for ladle

GN coperchi con spacco mestolo
GN-Deckel mit Löffel-Ausschnitt
GN couvercles avec encoche pour louche
GN tapas con orificio cacillo

art.	GN	dim. mm.
14821-00	2/1	650x530
14822-00	1/1	530x325
14825-00	1/2	325x265
14827-00	1/3	325x175
14828-00	1/4	264x162
14829-00	1/6	176x162
14830-00	1/9	176x108



Drainer plate

Falso fondo forato
Abtropfplatte
Plateau double fond perforé
Fondo perforado

art.	GN	dim. mm.
14851-00	2/1	650x530
14852-00	1/1	530x325
14855-00	1/2	325x265

TRITAN BPA FREE

GN FOOD PANS
CONTENITORI GN



TRITAN - COPOLYMER - BPA FREE -40°C+90°C.
The lids of the series 14800 polycarbonate and 14600 Tritan are interchangeable. Hermetic lids, NOT water-tight.

TRITAN COPOLIMERO - BPA FREE -40°C+90°C.
I coperchi della serie 14800 polycarbonato e 14600 Tritan sono intercambiabili. Coperchi ermetici, NON a tenuta stagna.

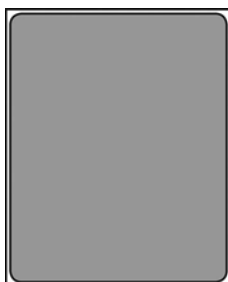

GN-containers

GN bacinelle
GN-Behälter
GN bacs
GN cubetas

art.	GN	dim. mm.	h. mm.	lt.
14661-20	2/1	650x530	200	55,5



art.	GN	dim. mm.	h. mm.	lt.
14662-06	1/1	530x325	65	9,0
14662-10	1/1	530x325	100	13,3
14662-15	1/1	530x325	150	20,0
14662-20	1/1	530x325	200	26,4



art.	GN	dim. mm.	h. mm.	lt.
14665-06	1/2	325x265	65	4,0
14665-10	1/2	325x265	100	6,1
14665-15	1/2	325x265	150	9,0
14665-20	1/2	325x265	200	11,9

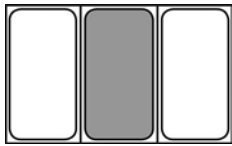

art.	GN	dim. mm.	h. mm.	lt.
14667-06	1/3	325x175	65	2,5
14667-10	1/3	325x175	100	3,8
14667-15	1/3	325x175	150	5,5
14667-20	1/3	325x175	200	7,1



art.	GN	dim. mm.	h. mm.	lt.
14668-06	1/4	264x162	65	1,7
14668-10	1/4	264x162	100	2,6
14668-15	1/4	264x162	150	3,8
14668-20	1/4	264x162	200	4,8

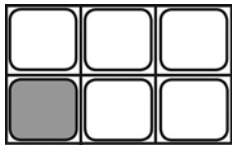

art.	GN	dim. mm.	h. mm.	lt.
14669-06	1/6	176x162	65	1,0
14669-10	1/6	176x162	100	1,6
14669-15	1/6	176x162	150	2,3
14669-20	1/6	176x162	200	2,8



art.	GN	dim. mm.	h. mm.	lt.
14670-06	1/9	176x108	65	0,6
14670-10	1/9	176x108	100	0,9



GN-lids
GN-coperchi
GN-Deckel
GN couvercles
GN tapas

art.	GN	dim. mm.
14671-00	2/1	650x530
14672-00	1/1	530x325
14675-00	1/2	325x265
14677-00	1/3	325x175
14678-00	1/4	264x162
14679-00	1/6	176x162
14680-00	1/9	176x108



GN-lids, hermetic
GN coperchi ermetici
GN-Deckel, hermetisch
GN couvercles hermétiques
GN tapas herméticas

art.	GN	dim. mm.
14682-00	1/1	530x325
14685-00	1/2	325x265
14687-00	1/3	325x175
14688-00	1/4	264x162
14689-00	1/6	176x162
14690-00	1/9	176x108



Drainer plate
Falso fondo forato
Abtropfplatte
Plateau double fond perforé
Fondo perforado

art.	GN	dim. mm.
14691-00	2/1	650x530
14692-00	1/1	530x325
14695-00	1/2	325x265

POLYPROPYLENE POLIPROPILENE

GN FOOD PANS
CONTENITORI GN



Transparent and stackable. Dish-washer safe. Do not use abrasive sponges and substances. Cold resistant up to -40°C . Heat resistant up to $+75^{\circ}\text{C}$. Graduation scale in liters. Lids tightly fitting.

Traslucide e impilabili. Lavabili in lavastoviglie con normali detersivi. Non utilizzare pagliette e sostanze abrasive. Termoresistenti da -40°C a $+75^{\circ}\text{C}$. Scala di graduazione in litri. Coperchio resistente per una perfetta chiusura stagna.



GN-containers

GN bacinelle
GN-Behälter
GN bacs
GN cubetas

art.	GN	dim. mm.	h. mm.	lt.
14702-06	1/1	530x325	65	8,5
14702-10	1/1	530x325	100	13,0
14702-15	1/1	530x325	150	19,5
14702-20	1/1	530x325	200	26,0



art.	GN	dim. mm.	h. mm.	lt.
14705-06	1/2	325x265	65	3,9
14705-10	1/2	325x265	100	5,9
14705-15	1/2	325x265	150	8,9
14705-20	1/2	325x265	200	11,8

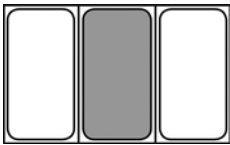

art.	GN	dim. mm.	h. mm.	lt.
14707-06	1/3	325x180	65	2,4
14707-10	1/3	325x180	100	3,6
14707-15	1/3	325x180	150	5,3
14707-20	1/3	325x180	200	7,0



art.	GN	dim. mm.	h. mm.	lt.
14708-06	1/4	265x160	65	1,7
14708-10	1/4	265x160	100	2,5
14708-15	1/4	265x160	150	3,7
14708-20	1/4	265x160	200	5,5



art.	GN	dim. mm.	h. mm.	lt.
14709-06	1/6	176x160	65	1,0
14709-10	1/6	176x160	100	1,5
14709-15	1/6	176x160	150	2,2
14709-20	1/6	176x160	200	3,4



art.	GN	dim. mm.	h. mm.	lt.
14710-06	1/9	176x110	65	1,3
14710-10	1/9	176x110	100	0,8



Drainer plate

Falso fondo forato
Abtropfplatte
Plateau double fond perforé
Fondo perforado

art.	GN	dim. mm.
14712-00	1/1	530x325
14715-00	1/2	325x265
14717-00	1/3	325x180
14718-00	1/4	265x160
14719-00	1/6	176x160



GN-lids
GN-coperchi
GN-Deckel
GN couvercles
GN tapas

art.	GN	dim. mm.	col.
14722-00	1/1	530x325	●
14722-11	1/1	530x325	●
14722-22	1/1	530x325	●
14722-33	1/1	530x325	●
14722-99	1/1	530x325	○



art.	GN	dim. mm.	col.
14725-00	1/2	325x265	●
14725-11	1/2	325x265	●
14725-22	1/2	325x265	●
14725-33	1/2	325x265	●
14725-99	1/2	325x265	○



art.	GN	dim. mm.	col.
14727-00	1/3	325x180	●
14727-11	1/3	325x180	●
14727-22	1/3	325x180	●
14727-33	1/3	325x180	●
14727-99	1/3	325x180	○



art.	GN	dim. mm.	col.
14728-00	1/4	265x160	●
14728-11	1/4	265x160	●
14728-22	1/4	265x160	●
14728-33	1/4	265x160	●
14728-99	1/4	265x160	○



art.	GN	dim. mm.	col.
14729-00	1/6	176x160	●
14729-11	1/6	176x160	●
14729-22	1/6	176x160	●
14729-33	1/6	176x160	●
14729-99	1/6	176x160	○



art.	GN	dim. mm.	col.
14730-00	1/9	176x110	●
14730-11	1/9	176x110	●
14730-22	1/9	176x110	●
14730-33	1/9	176x110	●
14730-99	1/9	176x110	○

POLYPROPYLENE POLIPROPILENE

GN FOOD PANS
CONTENITORI GN



Withstand temperatures from -40°C to $+80^{\circ}\text{C}$. With both metric and American graduated scale. **WARNING: polypropylene containers are not suitable for use on steam tables.** The lids of the series 14900 polypropylene and 15100 polypropylene IML are interchangeable. Hermetic lids, **NOT** water-tight.

Termoresistenti da -40°C a $+80^{\circ}\text{C}$. Dotati di scala graduata sia secondo sistema metrico che americano. **AVVERTENZE:** i contenitori in polipropilene non sono indicati per l'uso su tavole a vapore. I coperchi della serie 14900 polipropilene e 15100 polipropilene IML sono intercambiabili. Coperchi ermetici, **NON** a tenuta stagna.



GN-containers

GN bacinelle
GN-Behälter
GN bacs
GN cubetas

art.	GN	dim. mm.	h. mm.	lt.
14902-06	1/1	530x325	65	9,0
14902-10	1/1	530x325	100	13,3
14902-15	1/1	530x325	150	20,0
14902-20	1/1	530x325	200	26,4



art.	GN	dim. mm.	h. mm.	lt.
14905-06	1/2	325x265	65	4,0
14905-10	1/2	325x265	100	6,1
14905-15	1/2	325x265	150	9,0
14905-20	1/2	325x265	200	11,9

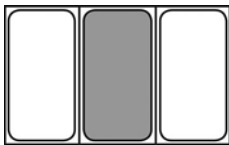

art.	GN	dim. mm.	h. mm.	lt.
14907-06	1/3	325x175	65	2,5
14907-10	1/3	325x175	100	3,8
14907-15	1/3	325x175	150	5,5
14907-20	1/3	325x175	200	7,1



art.	GN	dim. mm.	h. mm.	lt.
14908-06	1/4	264x162	65	1,7
14908-10	1/4	264x162	100	2,6
14908-15	1/4	264x162	150	3,8
14908-20	1/4	264x162	200	4,8

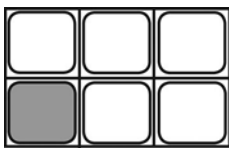

art.	GN	dim. mm.	h. mm.	lt.
14909-06	1/6	176x162	65	1,0
14909-10	1/6	176x162	100	1,6
14909-15	1/6	176x162	150	2,3
14909-20	1/6	176x162	200	2,8



art.	GN	dim. mm.	h. mm.	lt.
14910-06	1/9	176x108	65	0,6
14910-10	1/9	176x108	100	0,9



Drainer plate

Falso fondo forato
Abtropfplatte
Plateau double fond perforé
Fondo perforado

art.	GN	dim. mm.
14912-00	1/1	530x325
14915-00	1/2	325x265

GN-lids, hermetic
GN coperchi ermetici
GN-Deckel, hermetisch
GN couvercles hermétiques
GN tapas herméticas



art.	GN	dim. mm.	col.
14922-00	1/1	530x325	●
14922-11	1/1	530x325	●
14922-22	1/1	530x325	●
14922-33	1/1	530x325	●
14922-99	1/1	530x325	○



art.	GN	dim. mm.	col.
14925-00	1/2	325x265	●
14925-11	1/2	325x265	●
14925-22	1/2	325x265	●
14925-33	1/2	325x265	●
14925-99	1/2	325x265	○



art.	GN	dim. mm.	col.
14927-00	1/3	325x175	●
14927-11	1/3	325x175	●
14927-22	1/3	325x175	●
14927-33	1/3	325x175	●
14927-99	1/3	325x175	○



art.	GN	dim. mm.	col.
14928-00	1/4	264x162	●
14928-11	1/4	264x162	●
14928-22	1/4	264x162	●
14928-33	1/4	264x162	●
14928-99	1/4	264x162	○



art.	GN	dim. mm.	col.
14929-00	1/6	176x162	●
14929-11	1/6	176x162	●
14929-22	1/6	176x162	●
14929-33	1/6	176x162	●
14929-99	1/6	176x162	○



art.	GN	dim. mm.	col.
14930-00	1/9	176x108	●
14930-11	1/9	176x108	●
14930-22	1/9	176x108	●
14930-33	1/9	176x108	●
14930-99	1/9	176x108	○

IML POLYPROPYLENE POLIPROPILENE IML

GN FOOD PANS
CONTENITORI GN



With permanent in molded label. To write on the label there is a specific marker that can be removed by simply washing in the dishwasher. Withstand temperatures from -40°C to $+80^{\circ}\text{C}$. With both metric and American graduated scale. **WARNING:** polypropylene containers are not suitable for use on steam tables. The lids of the series 14900 polypropylene and 15100 polypropylene IML are interchangeable. Hermetic lids, NOT water-tight.

Con etichetta permanente costampata. Per scrivere sull'etichetta è disponibile un pennarello specifico che viene rimosso con il semplice lavaggio in lavastoviglie. Termoresistenti da -40°C a $+80^{\circ}\text{C}$. Scala graduata sia secondo sistema metrico che americano. **AVVERTENZE:** i contenitori in polipropilene non sono indicati per l'uso su tavole a vapore. I coperchi della serie 14900 polipropilene e 15100 polipropilene IML sono intercambiabili. Coperchi ermetici, NON a tenuta stagna.



GN-containers

GN bacinelle
GN-Behälter
GN bacs
GN cubetas

art.	GN	dim. mm.	h. mm.	lt.
15101-06	1/1	530x325	65	9,0
15101-10	1/1	530x325	100	13,3
15101-15	1/1	530x325	150	20,0
15101-20	1/1	530x325	200	26,4



art.	GN	dim. mm.	h. mm.	lt.
15105-06	1/2	325x265	65	4,0
15105-10	1/2	325x265	100	6,1
15105-15	1/2	325x265	150	9,0
15105-20	1/2	325x265	200	11,9

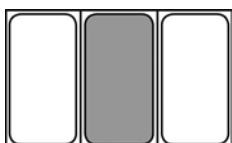

art.	GN	dim. mm.	h. mm.	lt.
15107-06	1/3	325x175	65	2,5
15107-10	1/3	325x175	100	3,8
15107-15	1/3	325x175	150	5,5
15107-20	1/3	325x175	200	7,1



art.	GN	dim. mm.	h. mm.	lt.
15108-06	1/4	264x162	65	1,7
15108-10	1/4	264x162	100	2,6
15108-15	1/4	264x162	150	3,8
15108-20	1/4	264x162	200	4,8



art.	GN	dim. mm.	h. mm.	lt.
15109-06	1/6	176x162	65	1,0
15109-10	1/6	176x162	100	1,6
15109-15	1/6	176x162	150	2,3
15109-20	1/6	176x162	200	2,8



art.	GN	dim. mm.	h. mm.	lt.
15110-06	1/9	176x108	65	0,6
15110-10	1/9	176x108	100	0,9



Clips for lids

Clips per coperchi
Clips für Deckel
Clips pour couvercles
Clips para tapas

art.	U. Pack	col.
15100-02	12	●
15100-03	12	●
15100-01	12	●
15100-04	12	●



Kit 2 markers

Set 2 pennarelli
Satz 2 Marker
Set 2 marqueurs
Juego 2 marcadores

art.
15100-AA



Melamine is suitable for hot and cold food use. Melamine is suitable for food storage at ambient or chilled temperatures for up to 24 hours. Melamine is not suitable for hot counters, displays, or heated cabinets. Do not expose melamine to direct flame or heat, including heat lamps and plate warmers. Temperature rating is between -20°C and 70°C (-4°F +158°F).

La melamina è adatta per l'uso sia con cibi caldi che freddi. La melamina è adatta per la conservazione degli alimenti a temperatura ambiente o refrigerata fino a 24 ore. La melamina non è adatta per piani caldi, espositori o armadi riscaldati. Non esporre a calore e fiamme dirette, incluse lampade alogene e scaldapiatti. Non esporre gli oggetti in melamina a temperature superiori a 70°C (-20°C +70°C).

GN-containers / Bacinelle / Behälter / Bacs / Cubetas



art.	GN	dim. mm.	h. mm.	lt.	col.
44877-11	1/1	530X325	65	7,1	○
44877B11	1/1	530X325	100	10,6	○
44878-11	1/1	530X325	65	7,1	●
44878B11	1/1	530X325	100	10,6	●



art.	GN	dim. mm.	h. mm.	lt.	col.
44877-24	2/4	160x530	65	3,0	○
44877B24	2/4	160x530	100	4,3	○
44878-24	2/4	160x530	65	3,0	●
44878B24	2/4	160x530	100	4,3	●



art.	GN	dim. mm.	h. mm.	lt.	col.
44877-12	1/2	325X265	65	3,4	○
44877B12	1/2	325X265	100	4,7	○
44878-12	1/2	325X265	65	3,4	●
44878B12	1/2	325X265	100	4,7	●

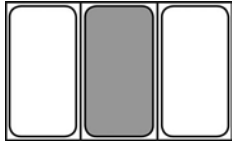

art.	GN	dim. mm.	h. mm.	lt.	col.
44877-13	1/3	325X175	65	2,0	○
44877B13	1/3	325X175	100	2,7	○
44878-13	1/3	325X175	65	2,0	●
44878B13	1/3	325X175	100	2,7	●



art.	GN	dim. mm.	h. mm.	lt.	col.
44877-14	1/4	265X160	65	1,4	○
44877B14	1/4	265X160	100	1,9	○
44878-14	1/4	265X160	65	1,4	●
44878B14	1/4	265X160	100	1,9	●



art.	GN	dim. mm.	h. mm.	lt.	col.
44877-16	1/6	175X160	65	0,8	○
44877B16	1/6	175X160	100	1,0	○
44878-16	1/6	175X160	65	0,8	●
44878B16	1/6	175X160	100	1,0	●



GN-lids, POLICARBONATE
GN-coperchi, POLICARBONATO
GN-Deckel, POLIKARBONAT
GN couvercles, POLICARBONATE
GN tapas, POLICARBONATO

PC

art.	GN	dim. mm.
44818-11	1/1	530X325
44818-12	1/2	325X265
44818-13	1/3	325X175
44818-14	1/4	265X160
44818-16	1/6	175X160



PORCELAIN PORCELLANA

GN FOOD PANS
CONTENITORI GN



GN-containers, PORCELAIN

GN bacinelle, POCELLANA, MELAMINA/MELAMINE

GN-Behälter, PORZELLAN

GN bacs, PORCELAINE

GN cubetas, PORCELANA

art.	GN	dim. mm.	h. mm.	col.
44332-03	1/1	530x325	20	○
44332-06	1/1	530x325	65	○
44382A06	1/1	530x325	65	●
44382B06	1/1	530x325	65	●
44382G06	1/1	530x325	65	●
44382O06	1/1	530x325	65	●
44382Y06	1/1	530x325	65	●
44332B06	1/1	530x325	65	●

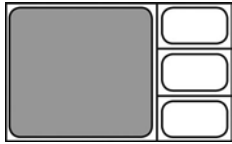

art.	GN	dim. mm.	h. mm.	col.
44333-03	2/3	353x320	20	○
44333-06	2/3	353x320	65	○
44333B06	2/3	353x320	65	●
44383O06	2/3	353x320	65	●
44383Y06	2/3	353x320	65	●

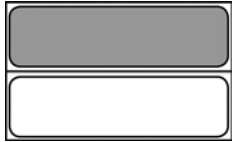

art.	GN	dim. mm.	h. mm.	col.
44334-03	2/4	162x530	20	○
44334-06	2/4	162x530	65	○
44384A06	2/4	162x530	65	●
44384O06	2/4	162x530	65	●
44384R06	2/4	162x530	65	●
44384Y06	2/4	162x530	65	●



art.	GN	dim. mm.	h. mm.	col.
44335-03	1/2	325x265	20	○
44335-06	1/2	325x265	65	○
44335B06	1/2	325x265	65	●
44385A06	1/2	325x265	65	●
44385B06	1/2	325x265	65	●
44385G06	1/2	325x265	65	●
44385O06	1/2	325x265	65	●
44385R06	1/2	325x265	65	●
44385Y06	1/2	325x265	65	●

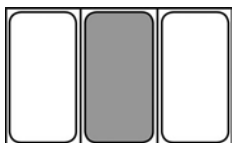

art.	GN	dim. mm.	h. mm.	col.
44337-03	1/3	325x175	20	○
44337-06	1/3	325x175	65	○
44337B06	1/3	325x175	65	●
44387A06	1/3	325x175	65	●
44387B06	1/3	325x175	65	●
44387G06	1/3	325x175	65	●
44387O06	1/3	325x175	65	●
44387R06	1/3	325x175	65	●
44387Y06	1/3	325x175	65	●



art.	GN	dim. mm.	h. mm.	col.
44338-03	1/4	265x160	20	○
44338-06	1/4	265x160	65	○



art.	GN	dim. mm.	h. mm.	col.
44339-03	1/6	176x160	20	○
44339-06	1/6	176x160	65	○

INDUCTION PORCELAIN PORCELLANA INDUZIONE

GN FOOD PANS
CONTENITORI GN





GN-containers, PORCELAIN
GN bacinelle, POCELLANA, MELAMINA/MELAMINE
GN-Behälter, PORZELLAN
GN bacs, PORCELAINE
GN cubetas, PORCELANA

art.	GN	dim. mm.	h. mm.	col.
44342-06	1/1	530x325	65	○
44312A06	1/1	530x325	65	●
44312B06	1/1	530x325	65	●
44312G06	1/1	530x325	65	●
44312O06	1/1	530x325	65	●
44312R06	1/1	530x325	65	●
44312Y06	1/1	530x325	65	●



art.	GN	dim. mm.	h. mm.	col.
44343-06	2/3	353x320	65	○
44313B06	2/3	353x320	65	●
44313G06	2/3	353x320	65	●
44313O06	2/3	353x320	65	●
44313R06	2/3	353x320	65	●
44313Y06	2/3	353x320	65	●



art.	GN	dim. mm.	h. mm.	col.
44344-06	2/4	162x530	65	○
44314A06	2/4	162x530	65	●
44314B06	2/4	162x530	65	●
44314G06	2/4	162x530	65	●
44314O06	2/4	162x530	65	●
44314R06	2/4	162x530	65	●
44314Y06	2/4	162x530	65	●



art.	GN	dim. mm.	h. mm.	col.
44345-06	1/2	325x265	65	○
44315A06	1/2	325x265	65	●
44315B06	1/2	325x265	65	●
44315G06	1/2	325x265	65	●
44315O06	1/2	325x265	65	●
44315R06	1/2	325x265	65	●
44315Y06	1/2	325x265	65	●

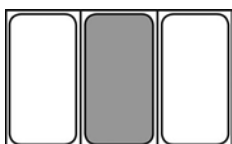

art.	GN	dim. mm.	h. mm.	col.
44347-06	1/3	325x175	65	○
44317A06	1/3	325x175	65	●
44317B06	1/3	325x175	65	●
44317G06	1/3	325x175	65	●
44317O06	1/3	325x175	65	●
44317R06	1/3	325x175	65	●
44317Y06	1/3	325x175	65	●



art.	GN	dim. mm.	h. mm.	col.
44346-06	1/4	265x160	65	○

SERIES 12900

KITCHEN UTENSILS
UTENSILI DA CUCINA

PA+
plus



A wide range of professional kitchen utensils in composite material, polyamide (nylon 6.6) with fiberglass. Dishwasher safe, can be sterilized, heat resistant up to 220°C. Safe for non-stick cookware.

Un'ampia gamma di utensili professionali per la cucina in materiale composito, poliammide (nylon 6.6) con fibra di vetro. Lavabili in lavastoviglie, sterilizzabili, resistenti fino a 220°C. Ideali per l'uso con antiaderenti.



PA+
plus

Spoon
Cucchiaione
Löffel
Mouvette
Cuchara

art.	l. cm.
12903-30	30
12903-40	38
12903-45	45



PA+
plus

Spatula
Spatola
Teigschäber
Spatule
Espátula

art.	l. cm.
12905-25	25
12905-30	30
12905-35	35
12905-40	40
12905-45	45
12905-50	50



PA+
plus

Stirring ladle
Spatola per stemperare
Rühr-u. Temperierlöffel
Spatule à délayer
Espátula para diluir

art.	l. cm.
12907-07	35
12907-08	35



PA+
plus

Spatula
Spatola
Stielschäber
Spatule
Espátula

art.	l. cm.
12915-25	25
12915-26	28
12915-35	35
12915-45	45



PA+
plus

Spatula
Spatola
Teigschäber
Spatule
Espátula

art.	l. cm.
12916-25	25
12916-33	33



PA+
plus

Spatula
Spatola triangolare
Dreieck-Stielschäber
Spatule trilon
Espátula triangular

art.	l. cm.
12917-25	25



PA+
plus

Bevelled spatula
Spatola smussata
Teigschäber
Spatule plate biseautée
Espátula blanda

art.	l. cm.
12906-35	35



PA+
plus

Spatula
Spatola
Teigschäber
Spatule
Espátula

art.	l. cm.
12908-30	30
12908-35	35
12908-40	40



PA+
plus

Angular spatula
Paletta angolare
Winkelpalette
Spatule angulaire
Espátula

art.	l. cm.
12909-12	12
12909-23	23



PA+
plus

Spatula, perforated
Paletta forata
Teigschäber, perforiert
Spatule ajourée
Espátula perforada

art.	l. cm.
12921-01	30



PA+
plus

Spatula, perforated
Paletta forata
Teigschäber, perforiert
Spatule ajourée
Espátula perforada

art.	l. cm.
12921-05	30



PA+
plus

Spatula
Paletta
Teigschäber
Spatule
Espátula

art.	l. cm.
12921-10	32



PA+
plus

Fish & chips spatula

Paletta fritti
Fischheber
Pelle à friture
Espátula fritura

art.	l. cm.
12921-15	35



PA+
plus

Ladle

Mestolo
Schöpfplößel
Louche
Cacillo

art.	Ø cm.	l. cm.
12920-01	9	31



PA+
plus

Skimmer

Schiumarola
Schaumlöffel
Ecumoire
Espumadera

art.	Ø cm.	l. cm.
12920-05	11	35



PA+
plus

Spatula

Paletta
Teigschäber
Spatule
Espátula

art.	cm.	l. cm.
12920-10	9x10	35



PA+
plus

Fish & chips spatula

Paletta fritti
Fischheber
Pelle à friture
Espátula fritura

art.	cm.	l. cm.
12920-11	9x10	35



PA+
plus

Spoon

Cucchiaione
Giesslöffel
Cuillère
Cucharón

art.	l. cm.
12920-15	35



PA+
plus

Perforated spoon

Cucchiaione forato
Giesslöffel, perforiert
Cuillère perforée
Cucharón perforado

art.	l. cm.
12920-16	35



PA+
plus

Salad tong

Molla insalata
Salatzange
Pince à salade
Pinza ensalada

art.	l. cm.
12930-51	25
12930-52	32



PA+
plus

Bread and pastry tong

Molla per pane e pasticceria
Brot-/Gebäckzange
Pince à pain et pâtisserie
Pinza para pan y pasteleria

art.	l. cm.
12930-62	18
12930-63	23



PA+
plus

Serving tong

Molla tutto servire
Servierzange
Pince à servir
Pinza servir

art.	l. cm.
12930-68	20
12930-69	25



PA+
plus

Spaghetti tong

Molla spaghetti
Spaghettizange
Pince à spaghetti
Pinza espagueti

art.	l. cm.
12930-74	24



PA+
plus

Toast and pastry tong

Molla per toast e dolci
Toast-/Gebäckzange
Pince à toast et tarte
Pinza para tostadas y dulces

art.	l. cm.
12930-77	21
12930-78	25



PA+
plus

Meat ball plier
Forbice per polpette
Fleischkugelzange
Pince à boulettes
Pinza albóndigas

art.	l. cm.
12931-51	17



PA+
plus

Quenelle plier
Forbice per chenelle
Quenellezange
Pince à quenelles
Pinza quenelles

art.	l. cm.
12931-53	19



PA+
plus

Perforated ladle
Mestolo forato
Schöpföffel, gelocht
Louche perforée
Cacillo perforado

art.	Ø cm.	l. cm.
12967-06	6,5	30
12967-10	10,0	37,5



PA+
plus

Ladle
Mestolo
Schöpföffel
Louche
Cacillo

art.	Ø cm.	l. cm.
12970-06*	6,5	30,0
12970-08	8,0	33,5
12970-10	10,0	37,5
12970-12	12,0	40,0

* With spout. – * Con becco.



PA+
plus

Pizza ladle, flat bottom
Mestolo pizza, fondo piatto
Schöpföffel
Louche
Cacillo

art.	Ø cm.	l. cm.
12968-10	10	27



PA+
plus

Ladle, short handle
Mestolo, manico corto
Schöpföffel mit kurzen Stiel
Louche, manche court
Cacillo, mango corto

art.	Ø cm.	l. cm.
12969-10	10	27



PA+
plus

Ladle, short handle
Mestolo, manico corto
Schöpföffel mit kurzen Stiel
Louche, manche court
Cacillo, mango corto

art.	Ø cm.	l. cm.
12969-06	6,5	24



PA+
plus

Spoon
Cucchiaione
Löffel
Cuillère
Cuchara

art.	l. cm.
12986-38	37,5



PA+
plus

Spoon, short handle
Cucchiaione, manico corto
Löffel mit kurzen Stiel
Cuillère, manche court
Cuchara, mango corto

art.	l. cm.
12986-01	23



PA+
plus

Skimmer
Schiumarola
Schaumlöffel
Ecumoire
Espumadera

art.	Ø cm.	l. cm.
12971-10	10	31
12971-12	12	37



PA+
plus

Spatula
Paletta liscia
Backschaufel
Spatule
Espátula lisa

art.	cm.	l. cm.
12972-10	10	36,5
12972-12	12	38,0



PA+
plus

Perforated spatula
Paletta forata
Backschaufel, perforiert
Spatule perforée
Espátula perforada

art.	cm.	l. cm.
12973-10	10	36,5
12973-12	12	38



PA+
plus

Conical colander

Colatutto tronco conico
Gemüsesieher
Passoire à légumes
Colador cónico

art.	Ø cm.	h.	lt.
12950-32	32	16	8
12950-40	40	20	12



SS
PA+
plus

Strainer

Colatutto
Sieb
Passoire
Colador multiuso

art.	cm.	l. cm.
12932-22	22x18,5	44
12932-26	26x21	47



SS
PA+
plus

Soup strainer

Colino a rete
Suppensieb
Passe-bouillon
Colador a red

art.	Ø cm.	l. cm.
12941-07	7	12
12941-10	10	12
12941-12	12	17
12941-14	14	17
12941-16	16	17
12941-18	18	17
12941-20	20	17
12941-23	23	27
12941-26	26	27



SS
PA+
plus

Wire whip, 8 silicone wires

Frusta, 8 fili silicone
Rührbesen, 8 Drähte aus Silikon
Fouet, 8 fils en silicone
Batidor, 8 varillas de siliconea

art.	l. cm.
12926-35	35



SS
PA+
plus

Wire whip, 8 wires

Frusta, 8 fili
Rührbesen, 8 Drähte
Fouet, 8 fils
Batidor, 8 varillas

art.	l. cm.
12928-25	25
12928-30	30
12928-35	35
12928-40	40
12928-45	45
12928-50	50
12928-55	55
12928-60	60



SS
PA+
plus

Egg whisk, 11 wires

Frusta media, 11 fili
Schneebeesen, 11 Drähte
Fouet, 11 fils
Batidor, 11 varillas

art.	l. cm.
12929-25	25
12929-30	30
12929-35	35
12929-40	40
12929-45	45



SS
PA+
plus

Balloon whisk

Frusta balloon
Schneebeesen
Fouet à blancs
Batidor tipo globo

art.	l. cm.
12927-35	35
12927-45	45

Water-tight, dishwasher safe. – Perfetta tenuta stagna, lavabile in lavastoviglie.

Water-tight, dishwasher safe. – Perfetta tenuta stagna, lavabile in lavastoviglie.

SERIES 48280 - 48278

KITCHEN UTENSILS
UTENSILI DA CUCINA



A wide range of professional kitchen utensils. These are essential tools to make original decorations as well as to ease the preparation of your recipes. All items are made of 18/10 stainless steel while their ergonomic handles are available both in stainless steel and Polypropylene. They are all hangable and can be cleaned in dishwasher. They boast a modern, functional design and are very easy to use.

Un'ampia gamma di utensili professionali per la cucina, indispensabili per creare decorazioni originali e fantasiose, ma utili anche per svolgere le più semplici operazioni in modo preciso e veloce. Tutti i pezzi sono realizzati in acciaio inox 18/10, mentre la manichatura ergonomica è prevista nella versione acciaio inox o polipropilene. Tutti gli articoli sono dotati di un foro sul manico per essere appesi. Lavabili in lavastoviglie. Il design è moderno e funzionale per il massimo comfort d'utilizzo.



Pizza knife

Coltello per pizza
Pizza-Messer
Couteau à pizza
Cuchillo pizza

art. l. cm.
48280-45 23,5

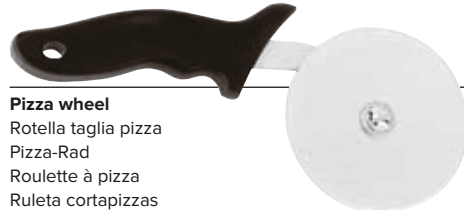

Pizza wheel

Rotella taglia pizza
Pizza-Rad
Roulette à pizza
Ruleta cortapizzas

art. Ø cm. l. cm.
18324-10 10 24



Pastry wheel

Rotella taglia pasta
Teig-Rad
Roulette à pâte
Ruleta cortapasta

art. Ø cm. l. cm.
48280-32 4 18



Double pastry wheel

Rotella taglia pasta doppia
Teig-Rad, doppel
Roulette à pâte double
Ruleta cortapasta doble

art. Ø cm. l. cm.
48280-39 4 18



Vegetables knife

Coltello verdure
Gemüsemesser
Couteau à crudités
Cuchillo verduras

art. l. cm.
48280-48 19



Parsley knife

Falcetta prezzemolo
Petersilie-Wiegemesser
Hachinette persil
Cuchillo perejil

art. Ø cm. l. cm.
48280-20 11 17



Cheese knife

Coltello grana
Käsemesser
Couteau à fromage
Cuchillo queso

art. l. cm.
48280-04 20



Oyster knife

Coltello apriostriche/cozze
Austernmesser
Couteau à huîtres
Cuchillo ostras

art. l. cm.
48280-05 20,5



Chestnut knife

Coltello castagne
Kastanienmesser
Couteau à marrons
Cuchillo castañas

art. l. cm.
48280-21 16



Fish scaler

Squamapesce
Fischentschupper
Ecailleur à poisson
Escamador

art. l. cm.
48280-38 23,5



Double fish scaler
Squamapesce doppio
Fischentschupper, doppel
Ecailleur à poisson double
Escamador doble

art. cm.
48280-37 22,5x3,5

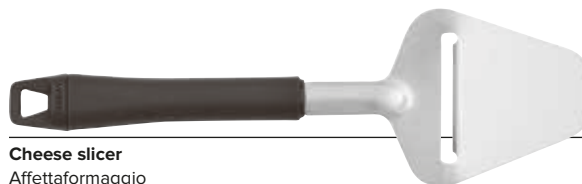

Cheese slicer
Affettaformaggio
Käsemesser
Couteau à fromage
Cuchillo para cortar queso

art. cm.
48280-41 25x7,6



Cheese cleaver
Mannaietta per formaggio
Käsemesser
Couteau à fromage
Hacha para queso

art. cm.
48280-49 21x4

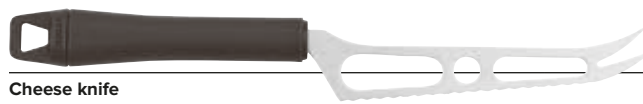

Cheese knife
Coltello formaggio
Käsemesser
Couteau à fromage
Cuchillo para queso

art. l. cm.
48280-59 27



Parmesan knife
Coltello grana
Käsemesser
Couteau à fromage
Cuchillo para queso parmesano

art. l. cm.
48280-46 24



Butter spreader
Spalmaburro
Butterstreicher
Couteau à tartiner
Cuchillo para untar

art. l. cm.
48280-75 21,5



Pie pan knife
Coltello tortiera
Tortenring-Messer
Couteau à manqué
Cuchillo para tartas

art. l. cm.
48280-22 21



Vegetable sharpener
Temperino per verdure
Gemüsefedermesser
Taille crayon légumes
Afilador para vegetales

art. Ø cm.
48280-12 4,5
48280-13 7,0



Pastry brush, silicone
Pennello silicone
Kuchenpinsel, Silikon
Pinceau, silicone
Pincel pastelería, silicona

art. cm.
48280-09 25,5x4



Pastry brush
Pennello
Kuchenpinsel
Pinceau
Pincel pastelería

art. cm.
48280-94 22,5x3,5



Ceddar/cheese grater

Grattugia formaggio
Käsereibe
Râpe à fromage
Rallador queso

art. l. cm.
48280-06 24



Bottle opener

Apribottiglie
Flaschenöffner
Décapsuleur
Abrebotellas

art. l. cm.
48280-02 19



Can opener

Apriscatole
Dosenöffner
Ouvre boîtes
Abrelatas

art. cm.
48280-03 22x4,6



Melon baller

Scavino
Kugelausstecher
Cuillère parisienne
Cortador bolas

art.	Ø cm.	l. cm.
48280-24	1,0	19,0
48280-30	1,5	19,0
48280-31	2,0	19,0
48280-35	2,3	19,5
48280-36	3,0	19,5



Double melon baller

Scavino doppio
Kugelausstecher, doppel
Cuillère parisienne, double
Cortador bolas, doble

art. Ø cm. l. cm.
48286-67 2,2-3,0 17



Oval melon baller

Scavino ovale
Kugelausstecher, oval
Moule à pommes, ovale
Cortador oval

art. Ø cm. l. cm.
48280-26 1,9 19,5



Zucchini corer, dented

Scavazucchine, seghettato
Gemüseausstecher
Vide-courgettes
Vaciador de zucchini

art. l. cm.
48280-54 24,5



Pineapple coring tool

Svuota ananas
Ananasausstecher
Vide ananas
Vacía corazón piña

art. l. cm.
48280-10 25



Asparagus peeler
Pelasparagi
Spargelschäler
Eplucheur à asperges
Pelador de espárrago
art. l. cm.
48280-85 23,5



Tomato peeler
Pelapomodori
Tomatenschäler
Eplucheur à tomates
Pelador de tomates
art. l. cm.
48280-08 18



Y-shaped swivel peeler
Sbucciatore a Y
Pendelschäler
Eplucheur
Pelador forma Y
art. l. cm.
48280-53 18,5
48280-52 21,0



Melon peeler
Sbuccia melone
Melonenschäler
Eplucheur à melon
Pelador de melon
art. Ø cm. l. cm.
48280-60 8,0 20
48280-61 9,0 21
48280-62 10,5 22
48280-63 12,0 23



Potato peeler
Pelapatate
Sparschäler
Eplucheur
Pelador de patatas
art. l. cm.
48280-34 19,5



Orange peeler
Pelarance
Orangenschäler
Eplucheur à oranges
Pelador de naranjas
art. l. cm.
48280-96 20



Grapefruit knife
Coltello per pompelmo
Grapefruitmesser
Couteau à pamplemousse
Cuchillo para pomelo
art. l. cm.
48280-47 21,5



Citrus knife
Coltello agrumi
Zitrus-Messer
Couteau à agrumes
Cuchillo para cítricos
art. l. cm.
48280-97 23



Fruit scoop
Porzionatore macedonia
Fruchtportionierer
Cuiller à fruits
Raciondor de ensalada de frutas
art. l. cm.
48280-15 20



Butter curler
Arricciaburro
Butter Lockenwickler
Coquilleur à beurre
Rizador de mantequilla
art. l. cm.
48280-11 22,5



Fruit decorating knife

Coltello decora frutta
Dekoriermesser
Denteleur
Cuchillo para decorar fruta

art. l. cm.
48280-91 23



Decorator

Decoratore
Ziseliermesser
Canneleur
Decorador

art. l. cm.
48280-95 16,5



Lemon striper

Decora limoni
Zesteur
Canneleur
Decorador de limones

art. l. cm.
48280-92 17



Lemon striper

Rigalimoni
Zesteur
Canneleur
Acanalar de limones

art. l. cm.
48280-90 17



Apple corer

Levatorisoli
Entkerner
Vide-pommes
Descorazonador

art. Ø cm. l. cm.
48280-25 1,2 21



Vegetable cutter

Tagliaverdure ondulato
Wellenschneider
Découpoir à lame ondulée
Cortador de verduras ondulado

art. l. cm.
48280-23 11,5



Whisk

Frusta
Rührbesen
Fouet
Batidor

art. Ø cm. l. cm.
48278-24 5 26,5



Pizza wheel

Rotella taglia pizza
Pizza-Rad
Roulette à pizza
Ruleta cortapizzas

art. Ø cm. l. cm.
48278-33 7 21



Pastry wheel

Rotella taglia pasta
Teig-Rad
Roulette à pâte
Ruleta cortapasta

art. Ø cm. l. cm.
48278-32 4 18



Double pastry wheel

Rotella taglia pasta doppia
Teig-Rad, doppel
Roulette a pâte double
Ruleta cortapasta doble

art. Ø cm. l. cm.
48278-39 4 18



Fish scaler

Squamapesce
Fischentschupper
Ecailleur à poisson
Escamador

art.	l. cm.
48278-38	22



Paring knife

Spelucchino
Spickmesser
Couteau d'office
Cuchillo moldeador

art.	l. cm.
48278-55	22,5



Conical colander

Colino conico
Suppensieb
Passe-bouillon
Colador cónico

art.	Ø cm.	l. cm.
48278-13	16	35



Soup strainer

Colino
Suppensieb
Passe-bouillon
Colador

art.	Ø cm.	l. cm.
48278-12	8	27



Vegetables knife

Coltello verdure
Gemüsemesser
Couteau à crudités
Cuchillo de verduras

art.	l. cm.
48278-48	19



Cheese slicer

Affettaformaggio tenero
Käsemesser
Couteau à fromage
Cortador de queso suave

art.	cm.
48278-42	20x7,5



Cheese cleaver

Mannaietta per formaggio
Käsemesser
Coutau à fromage
Hachita para queso

art.	cm.
48278-49	21x4



Cheese knife

Coltello parmigiano
Käsemesser
Coutau à fromage
Cuchillo para queso

art.	l. cm.
48278-46	23,5



Cheese slicer

Affettaformaggio
Käsereibe
Couteau à fromage
Cortador de queso

art.	l. cm.
48278-41	25



Potato masher

Pressapatate
Kartoffelpresse
Presse-purée
Prensador de patatas

art.	cm.	l. cm.
48278-87	8x7	27



Potato masher

Pressapatate
Kartoffelpresse
Presse-purée
Prensador de patatas

art. cm.
48278-31 27x8



Butter spreader

Spalmaburro
Buttermesser
Couteau à beurre
Cuchillo mantequilla

art. l. cm.
48278-75 21



Grater

Grattugia
Reibe
Râpe
Rallador

art. cm.
48278-20 25,5x5,5

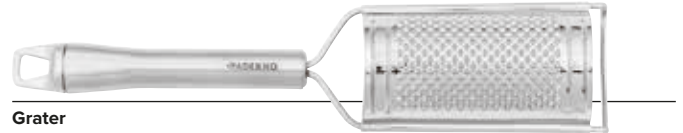

Grater

Grattugia
Reibe
Râpe
Rallador

art. cm.
48278-21 25,5x5,5



Oyster/cheese knife

Coltello apristriche/grana
Austern-/Käsemesser
Couteau à huîtres/fromage
Cuchillo para ostras/queso

art. l. cm.
48278-45 20



Spatula

Spatola per glassa
Palette
Spatule
Espátula

art. l. cm.
48278-77 27,5



Pastry brush

Pennello pasticceria
Kuchenpinsel
Pinceau à cuisine
Pincel pastelería

art. l. cm.
48278-94 22



Garlic press

Spremiaglio
Knoblauchpresse
Presse-ail
Prensador de ajo

art. cm.
48278-37 19x5

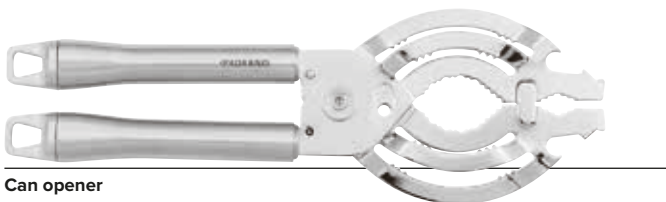

Can opener

Apribarattoli
Deckelöffner
Ouvre-boîtes
Abrelatas

art. cm.
48278-01 25,5x8,5



Bottle opener

Apribottiglie
Flaschenöffner
Ouvre-bouteilles
Abrebotellas

art. cm.
48278-02 19x3,7



Can opener

Apriscatole
Dosenöffner
Ouvre-boîtes
Abrelatas

art. cm.
48278-03 22x4,6



Potato peeler

Pelapatate
Kartoffelschäler
Eplucheur
Pelador de patatas

art. l. cm.
48278-34 19,5



Melon baller

Scavino sferico
Kugelausstecher
Moule à pommes
Vaciador

art. Ø cm. l. cm.
48278-35 3 18



Orange peeler

Pelarence
Orangenschäler
Eplucheur à pamplemousse
Pelador de naranja

art. l. cm.
48278-96 20



Grapefruit knife

Coltello per pompelmo
Orangenschäler
Couteau à pamplemousse
Cuchillo para pomelo

art. l. cm.
48278-47 21,5



Ice cream scoop

Porzionatore gelato
Eisportionierer
Cuillère à glace
Racionador de helado

art. Ø cm. l. cm.
48278-95 4 21



Zucchini corer, dented

Scavazucchine, seghettato
Gemüseausstecher
Vide-courgettes
Vaciador de zucchini, dentado

art. l. cm.
48278-54 25



Swivel peeler

Sbucciatore a lama mobile
Pendelschäler
Eplucheur
Pelador a cuchilla mobile

art. l. cm.
48278-52 21



Y-shaped swivel peeler

Sbucciatore a Y
Pendelschäler
Eplucheur
Pelador forma Y

art. l. cm.
48278-53 18,5



Apple corer

Levatoroli
Entkerner
Vide-pomme
Descorazonador

art. Ø cm. l. cm.
48278-25 1,6 21,5



Potato fork

Forchettina 3 punte
Gabelchän
Petite fourchette
Tenedor tre puntas

art. l. cm.
48278-17 16,5



Coffee measuring spoon

Dosa caffè
Maßlöffel
Cuillère à mesure
Porcionador de café

art. Ø cm. l. cm.
48278-16 3,5 20



Egg separator

Separauova
Eier-Trenner
Sépare oeufs
Separador de huevos

art. Ø cm. l. cm.

48278-36 5,5 20,5



Decorating knife

Coltello decora frutta
Dekoriermesser
Couteau à décorer
Cuchillo para decorar frutas

art. l. cm.

48278-91 22,5



Cocktail spoon

Cucchiaio cocktail
Cocktailöffel
Cuiller à cocktail
Cuchara cóctel

art. Ø cm. l. cm.

48278-15 6 28



Lemon striper

Decora limoni
Zesteur
Canneleur
Decorador de limones

art. l. cm.

48278-92 16,5



Butter curler

Arricciaburro
Buttermesser
Couteau à beurre
Ruzador de mantequilla

art. l. cm.

48278-11 21,5



Smell-remover soap

Saponetta toglì odori
Geruchentferner-Seife
Savonette enlève odeurs
Jabon quita odores

art. cm.

48278-99 7,5x5,5



Sauce ladle

Mestolino salsa
Saucenlöffel
Louche à sauce
Cacillo salsa

art. Ø cm. l. cm.

48278-68 7 29



Ladle

Mestolo
Schöpflöffel
Louche
Cazo

art. Ø cm. l. cm.

48278-69 9 32

48278-66 6 29



Salad fork

Forchetta insalata
Saltgabel
Fourchette à salade
Tenedor para ensaladas

art. Ø cm. l. cm.

48278-64 5 25,5



Salad spoon

Cucchiaio insalata
Salatlöffel
Cuiller à salade
Cuchara para ensaladas

art. Ø cm. l. cm.
48278-62 5 25



Perforated spoon

Cucchiaio forato
Giesslöffel, perforiert
Cuiller perforé
Cuchara perforada

art. cm.
48278-61 34x6



Slotted turner

Paletta forata
Küchenwender
Pelle ajourée
Espátula perforada

art. cm.
48278-71 34,5x8,5

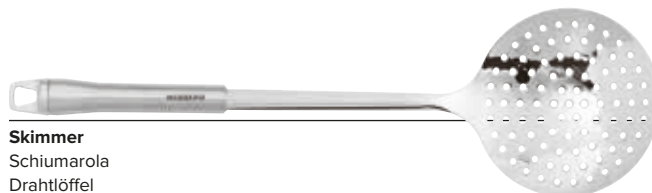

Skimmer

Schiumarola
Drahtlöffel
Ecumoir
Espumadera

art. Ø cm. l. cm.
48278-73 11 37

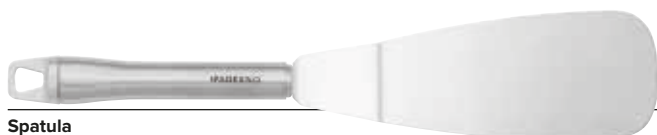

Spatula

Spatola
Palette
Spatule
Espátula

art. cm.
48278-76 28,5x5,6



Pie server

Pala torta
Tortenheber
Pelle à gâteau
Paleta para tartas

art. cm.
48278-93 26x5,8

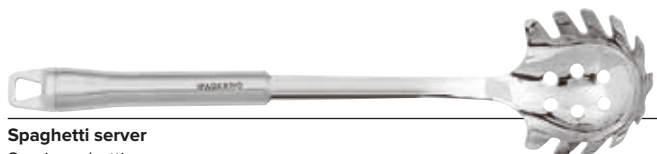

Spaghetti server

Servispaghetti
Spaghettilöffel
Cuiller à spaghetti
Servidor para espagueti

art. Ø cm. l. cm.
48278-74 7 30,5



Fork

Forchettone
Gabel
Fourchette
Tenedor

art. l. cm.
48278-65 32,5



Rice spoon

Cucchiaio risotto
Reislöffel
Rice spoon
Cuchara para risotto

art. l. cm.
48278-63 27



Lasagne spatula

Pala pasticcio
Palette
Pelle
Pala para pastel

art. cm.
48278-27 29x4,5



Skimmer
Schiumarola
Drahtlöffel
Ecumoir
Espumadera

art.	Ø cm.	l. cm.
48278-88	11	36,5



Ladle
Mestolo
Schöpflöffel
Louche
Cazo

art.	Ø cm.	l. cm.
48278-84	9,5	32,5



Rice spoon
Cucchiaio riso
Giesslöffel
Cuiller
Cuchara

art.	cm.
48278-82	33x6,5



Perforated spoon
Cucchiaio forato
Giesslöffel, perforiert
Cuiller ajouré
Cuchara perforada

art.	cm.
48278-81	33x6,5



Spaghetti server
Servispaghetti
Spaghettillöffel
Cuiller à spaghetti
Servidor para espagueti

art.	cm.
48278-89	32x6,5



Meat fork
Forchettone
Gabel
Fourchette
Tenedor

art.	l. cm.
48278-83	32,5



Silicone spoon
Cucchiaio silicone
Löffel aus Silikon
Cuiller en silicone
Cucharón de silicona

art.	cm.	l. cm.
48278-14	5,5x8	26,5



Perforated turner
Paletta forata
Küchenwender, perforiert
Pelle ajourée
Pala perforada

art.	cm.
48278-85	33x8,5



Silicone turner
Paletta silicone
Palette aus Silikon
Pelle en silicone
Paleta de silicona

art.	cm.	l. cm.
48278-28	5x9	28,5

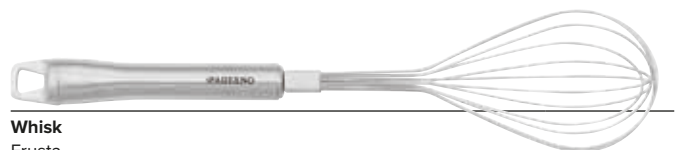

Whisk
Frusta
Rührbesen
Fouet
Batidor

art.	l. cm.
48278-18	24,5
48278-19	29,5

TURNERS SPATOLE

KITCHEN UTENSILS
UTENSILI DA CUCINA

SS PP



Stainless steel turners with polypropylene handle.

Spatole in acciaio inox con manico in polipropilene.



Perforated spatula

Paletta forata
Kuchenpalette, geschlitzt
Palette perforée
Paleta perforada

art. cm.
18510-07 13,5x7



Perforated spatula

Spatola forata
Kuchenpalette, geschlitzt
Palette perforée
Paleta perforada

art. cm.
18509-01 16x7,5
18509-02 15,6x5



Perforated spatula, flexible

Paletta forata, flessibile
Palette, geschlitzt, flexibel
Palette perforée, flexible
Paleta perforada, flexible

art. cm.
18509-03 15,6x8,7



Pizza turner

Spatola per pasticcio e pizza
Pizzawender
Palette à pizza
Espátula pizza

art. cm.
18511-15 15,5x8,7



Hamburger turner

Spatola hamburger
Hamburgerspachtel
Palette à hamburger
Espátula hamburger

art. cm.
18512-15 19x13,8



Lasagne spatula

Spatola lasagne
Lasagneheber
Palette à lasagne
Espátula lasagna

art. cm.
18515-16 16,8x7,2



Cleaning spatula

Spatola triangolare
Bratenspachtel
Spatule
Espátula triangular

art. cm.
18520-04 12x4
18520-06 12x6
18520-08 12x8
18520-10 12x10
18520-12 12x12



Hamburger turner

Spatola hamburger
Bratenwender
Grand palette
Espátula hamburger

art. cm.
18516-24 24x7,2



Perforated hamburger turner

Spatola hamburger, forata
Bratenspachtel, gelocht,
Grand palette perforée
Espátula hamburger, perforada

art. cm.
18517-24 24x7,2



Angular spatula

Spatola cuoco con scalino
Confiseriepalette
Palette coudée
Espátula chef angular

art. cm.
18518-22 22x3,4
18518-26 25x3,7
18518-30 30x4,3



Spatula

Spatola cuoco
Palette
Palette
Espátula chef

art. cm.
18519-15 15,5x3
18519-22 22x3,4
18519-26 26x3,7
18519-30 31x4,3
18519-35 36x5



Pastry spatula

Paletta dolci
Gebäckpalette
Palette à gâteau
Pala pasteles

art. cm.
18513-14 14,5x6,5



Pastry spatula

Spatola dolce
Kuchenpalette
Palette à pâtissier
Espátula dulces

art. cm.
18514-17 16,3x5,8



Pie knife

Coltello torta
Tortenmesser
Couteau à gâteau
Cuchillo pasteles

art. cm.
18514-18 17,3x5,8



Farinata knife

Coltello per farinata
Farinata Messer
Couteau à farinata
Cuchillo farinata

art. l. cm.
42830-08 8

LADLES MESTOLI

KITCHEN UTENSILS
UTENSILI DA CUCINA



The PADERNO ladle.
Handle-cup connection (one piece ladle). Thicker handle with rounded border.
Diameter and capacity stamped on the handle.

Il mestolo PADERNO.
Accoppiamento manico-coppa (mestolo unipiece). Manico con spessore maggiorato con bordi arrotondati. Indicazione sul manico del diametro e della capacità.



One piece ladle

Mestolo unipezzo
Schöpflöffel, fugenlos
Louche monobloc
Cacillo monobloc

art.	Ø cm.	l. cm.	lt.
11970-06	6,5	30	0,07
11970-08	8,0	32	0,12
11970-09	9,0	33	0,20
11970-10	10,0	37	0,25
11970-11	11,0	38	0,33
11970-12	12,0	40	0,50
11970-14	14,0	44	0,75
11970-16	16,0	47	1,00



Ladle, tube handle

Mestolo con manico a tubo
Schöpflöffel mit Rohrstiel
Louche avec manche tubulaire
Cacillo con mango tubolar

art.	Ø cm.	l. cm.	lt.
11968-18	18	75	1,5
11968-20	20	75	2,0
11968-24	24	75	4,0



One piece perforated ladle

Mestolo forato unipezzo
Gelochter Schöpflöffel, fugenlos
Louche monobloc perforée
Cacillo monobloc perforado

art.	Ø cm.	l. cm.	lt.
11967-06	7	30	0,07
11967-08	8	32	0,12
11967-09	9	33	0,20
11967-10	10	37	0,25
11967-12	12	40	0,50
11967-14	14	44	0,75
11967-16	16	47	1,00



Perforated ladle, tube handle

Mestolo forato con manico a tubo
Schöpflöffel, gelocht mit Rohrstiel
Louche perforée, manche tubulaire
Cacillo perforado mango tubolar

art.	Ø cm.	l. cm.	lt.
11967-18	18	75	1,5
11967-20	20	75	2,0
11967-24	24	75	4,0



One piece side basting spoon

Mestolo becco a versare unipezzo
Saucenkelle quer, fugenlos
Cuillère à arroser monobloc
Cacillo monobloc para versar

art.	Ø cm.	l. cm.	lt.
11969-06	6,5	30	0,07
11969-37*	6,5	30	0,07

*Left handed. – Per mancini.



One piece basting spoon

Cucchiaione unipezzo
Giesslöffel, fugenlos
Cuillère monobloc
Cucharón monobloc

art.	l. cm.
11982-38	38



One piece perforated spoon

Cucchiaione forato unipezzo
Giesslöffel perforiert, fugenlos
Cuillère perforée monobloc
Cucharón perforado monobloc

art.	l. cm.
11984-38	38



One piece spoon, crosswise

Cucchiaione obliquo unipezzo
Giesslöffel quer, fugenlos
Cuillère oblique monobloc
Cucharón obliquo monobloc

art.	l. cm.
11983-38	38
11983-37*	38

*Left handed. – Per mancini.



One piece meat fork, 3 prongs

Forchettone 3 denti unipezzo
Fleischgabel 3 Zacken, fugenlos
Fourchette 3 dents, monobloc
Tenedor 3 dientes, monobloc

art.	l. cm.
11974-50	50
11974-70	70



NSF
SS

One piece meat fork, 2 prongs
Forchettone 2 denti unipezzo
Fleischgabel 2 Zacken, fugenlos
Fourchette 2 dents, monobloc
Tenedor 2 dientes, monobloc

art.	l. cm.
11975-50	50
11975-99	100



NSF
SS

One piece spatula
Paletta liscia unipezzo
Backschaufel, fugenlos
Spatule monobloc
Espátula lisa monobloc

art.	cm.	l. cm.
11972-10	10	36
11972-12	12	39



NSF
SS

One piece perforated spatula
Paletta forata unipezzo
Backschaufel perforiert, fugenlos
Spatule perforée monobloc
Espátula perforada monobloc

art.	cm.	l. cm.
11973-10	10	36
11973-12	12	39



NSF
SS

Perforated slice
Pala a ridurre
Reduzierspatel
Spatule à réduire
Espátula para reducir

art.	cm.	l. cm.
11976-50	12x15	50
11976-99	12x15	100



NSF
SS

One piece fish spatula
Paletta pesce unipezzo, forata
Fischwender, fugenlos
Pelle à poisson monobloc
Pala pescado, monobloc

art.	cm.	l. cm.
11985-34	15x20	42



NSF
SS

One piece skimmer
Schiumarola unipezzo
Schaumlöffel, fugenlos
Ecumoire monobloc
Espumadera monobloc

art.	Ø cm.	l. cm.
11971-08	8	29,0
11971-10	10	32,0
11971-12	12	35,0
11971-14	14	38,0
11971-16	16	41,0
11971-18	18	42,5
11971-20	20	44,5



NSF
SS

One piece skimmer, tube handle
Schiumarola unipezzo, manico a tubo
Schaumlöffel, fugenlos, mit Rohrstiel
Ecumoire monobloc, manche tubulaire
Espumadera monobloc, mango tubolar

art.	Ø cm.	l. cm.
11971-25	25	75



NSF
SS

One piece ladle
Mestolo unipezzo
Schöpföffel, fugenlos
Louche monobloc
Cacillo monobloc

art.	Ø cm.	l. cm.	lt.
11970-01	8	23	0,12

Short handle. – Manico corto.



NSF
SS

Side basting spoon
Mestolo con becco a versare
Saucenkelle mit seitlichem Ausguß
Cuillère à arroser
Cacillo para versar

art.	Ø cm.	l. cm.	lt.
11969-02	6,5	23	0,07

Short handle. – Manico corto.



NSF
SS

One piece spoon
Cucchiaione unipezzo
Giesslöffel, fugenlos
Cuillère monobloc
Cuchara monobloc

art.	l. cm.
11982-01	23,5

Short handle. – Manico corto.



NSF
SS

One piece meat fork
Forchettone unipezzo
Fleischgabel, fugenlos
Fourchette monobloc
Tenedor monobloc

art.	l. cm.
11975-01	26

Short handle. – Manico corto.



NSF
SS

One piece perforated spatula
Paletta forata unipezzo
Backschaufel perforiert, fugenlos
Spatule perforée monobloc
Espátula perforada monobloc

art.	cm.	l. cm.
11973-01	8x9,5	24

Short handle. – Manico corto.



NSF
SS

One piece skimmer
Schiumarola unipezzo
Schaumlöffel, fugenlos
Ecumoire monobloc
Espumadera monobloc

art. Ø cm. l. cm.
11971-01 9 26

Short handle. – Manico corto.



SS

Ladle
Mestolo
Schöpflöffel
Louche
Cacillo

art. Ø cm. l. cm. lt.
41670-06 6 30 0,03
41670-09 9 32 0,13



SS

Skimmer
Schiumarola
Schaumlöffel
Ecumoire
Espumadera

art. Ø cm. l. cm.
41671-11 11 32



SS

Slotted turner
Paletta forata
Küchenwender, geschlitzt
Pelle ajourée
Espátula perforada

art. l. cm.
41672-00 32



SS

Spaghetti spoon
Cucchiaio per spaghetti
Spaghettilöffel
Cuillère à spaghetti
Tenedor espaguetitis

art. l. cm.
41673-00 32



SS

Meat fork
Forchettone
Fleischgabel
Fourchette
Tenedor

art. l. cm.
41674-00 32



SS

Basting spoon
Cucchiaione
Giesslöffel
Cuillère
Cuchara

art. l. cm.
41675-00 32



SS

Perforated spoon
Cucchiaione forato
Schöpfkelle, gelocht
Cuillère percée
Cuchara perforada

art. l. cm.
41676-00 32



SS

Sauce ladle
Cucchiaione salse
Saucenkelle
Cuillère à sauce
Cuchara salsas

art. l. cm.
41677-00 32



SS

Whisk
Frusta
Schneebesen
Fouet
Batidor

art. l. cm.
41678-00 30



SS

Wall rack
Asta
Aufhängungstange
Tringle de cuisine
Asta para utensilios

art. l. cm.
41670-AA 40
41670-AB 60



SS

Mesh skimmer
Schiumarola a rete stirata
Schaumlöffel
Ecumoire
Espumadera

art. Ø cm. l. cm.
11990-16 16 40



SS

Mesh skimmer
Schiumarola a rete passabrodo
Schaumlöffel
Ecumoire
Espumadera

art. Ø cm. l. cm.
11991-16 16 40

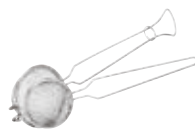

SS

Bird nest fryer
Colafritto
Nestbacklöffel
Nid à friture
Molde nido

art. Ø cm. l. cm.
42623-10 10 26



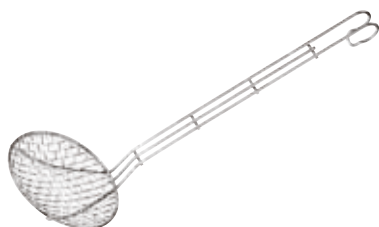

SS

Wire skimmer
Schiumarola a filo
Drahtlöffel
Araignée
Araña

art.	Ø cm.	l. cm.
12640-14	14	40
12640-16	16	40
12640-18	18	40
12640-20	20	50
12640-24	24	50
12640-28	28	50

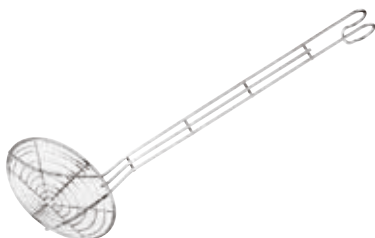

SS

Wire skimmer
Schiumarola a filo
Drahtlöffel
Araignée
Araña

art.	Ø cm.	l. cm.
12641-14	14	40
12641-16	16	40
12641-18	18	40
12641-20	20	50
12641-24	24	50
12641-28	28	50



SS

Wire skimmer
Schiumarola a filo
Drahtlöffel
Araignée
Araña

art.	Ø cm.	l. cm.
12642-28	28	85



SS

French fry scoop
Pala per patate fritte
Frittenschaufel
Pelle à frites
Pala chips

art.	cm.
41929-00	20x23



NEW

ABS

French fry scoop
Pala per patate fritte
Frittenschaufel
Pelle à frites
Pala chips

art.
41929-02

Ambidextrous. – Ambidestro.



W

Spatula
Spatola
Schäber
Spatule
Espátula

art.	l. cm.
42907-01	25
42907-02	30
42907-03	35
42907-04	40
42907-06	50
42907-07	60
42907-08	80
42907-09	100
42907-10	120



W

Mixing spoon
Cucchiaione
Löffel
Cuillère
Cuchara

art.	l. cm.
42901-20	20
42901-25	25
42901-30	30
42901-35	35
42901-40	40



W

Spatula
Spatola
Schäber
Spatule
Espátula

art.	l. cm.
42907-30	30
42907-35	35
42907-40	40



W

Crepe spreader, 5 pcs
Spatole crêpes, 5 pz
Crêpe-Paletten, 5 Stk
Rateau à crêpes/raclettes, 5 pcs
Espátula crêpes, 5 pz

art.	cm.
42900-15	18x18
42900-24	18x24

Beachwood. – Faggio.



SS

Baster tube
Pompetta per sugo
Soft-Spritze
Pompe à jus
Bomba para jugo

art.	l. cm.
42863-00	20



SS

Fish-bone remover
Pinza togli lische
Grätenentkerner
Pince à arêtes
Pinza para espinas

art.	l. cm.
42592-01	12
42592-02	12

01 thin bones, 02 thick bones.
01 lische fini, 02 lische grosse.



SS

Cooking tong
Pinza
Kochzange
Pince
Pinza

art.	l. cm.
42904-01	16



SS

Cooking tong
Pinza
Kochzange
Pince
Pinza

art.	l. cm.
42904-02	16



SS

Cooking tong
Pinza
Kochzange
Pince
Pinza

art.	l. cm.
42904-03	15



SS

Sausage tongs
Pinza per grill
Grill-und Wurstzange
Pince à saucisses
Pinza para barbacoa

art.	l. cm.
41697-00	38



SS

Cooking tong
Pinza
Kochzange
Pince
Pinza

art.	l. cm.
42902-31	30



SS

Cooking tong
Pinza
Kochzange
Pince
Pinza

art.	l. cm.
42902-30	30



SS

Grill tweezer
Molla per grill
Grillzange
Pince à grill
Pinza para barbacoa

art.	l. cm.
41698-22	22,5
41698-30	30,0
41698-40	40,0



SS

Serving tong
Pinza a servire
Servierzange
Pince à servir
Pinza para servir

art.	l. cm.
42854C25	25
42854C30	30



SS

Serving tong
Pinza a servire
Servierzange
Pince à servir
Pinza para servir

art.	l. cm.
42854B25	25
42854B30	30



SS

Serving tong
Pinza a servire
Servierzange
Pince à servir
Pinza para servir

art.	l. cm.
42854Y25	25
42854Y30	30



SS

Serving tong
Pinza a servire
Servierzange
Pince à servir
Pinza para servir

art.	l. cm.
42854K25	25
42854K30	30



SS

Serving tong
Pinza a servire
Servierzange
Pince à servir
Pinza para servir

art.	l. cm.
42854R25	25
42854R30	30



SS

Serving tong
Pinza a servire
Servierzange
Pince à servir
Pinza para servir

art.	l. cm.
42854G25	25
42854G30	30



Cooking tong, silicone

Pinza, silicone
Kochzange aus Silikon
Pince en silicone
Pinza de silicona

art.	l. cm.
42903-29	29



Barbecue brush

Spazzola grill
Grill-Bürste
Brosse à grille
Cepillo para barbacoa

art.	cm.	l. cm.
41773-00	5,5x11	27

Brass bristles. – Setole in ottone.



SS

Whisk for basin

Frusta gigante
Kesselbesen
Fouet à bassine
Batidor gigante

art.	l. cm.
41980-99	125



Food-grade resin spatula

Spatola in resina alimentare
Rührspaten für Speisenzubereitung
Spatule en résine pour aliments
Espátula de resina para alimentos

art.	cm.	l. cm.
44061-08	15,7x10,8	80
44061-09	23,5x10,8	90
44061-12	23,5x10,8	117
44061-14	23,5x10,8	137



SS

Speed rack

Rastrelliera
Flaschenregal
Rack à bouteilles
Rack de botellas

art.	cm.	h.	bot.
44060-50	56x10,5	15,5	6
44060-80	81x10,5	15,5	8



SS

Hat pin for tickets

Spillone portascontrini
Kassenscheine-Aufstecknadel
Pique-addition
Pinchanotas

art.	Ø cm.	h.
12504-20	9	20



W

Hat pin for tickets

Spillone portascontrini
Kassenscheine-Aufstecknadel
Pique-addition
Pinchanotas

art.	cm.	l. cm.
42504-09	9x5,5	10,5



SS

Tickets-holder

Asta portascontrini
Bons-/Zettelhalter
Porte-fiches à billes
Barra de notas

art.	l. cm.
42509-25	25
42509-50	50



SS

Tab-grabber

Asta porta scontrini
Bons-/Zettelhalter
Porte-fiches
Barra de notas

art.	l. cm.
42509-60	60
42509-99	100



SS

Roll holder

Porta rotolo
Rollenhalter
Derouleur papier
Portarollos

art.	l. cm.
42512-35	30



SS

Wall film box

Supporto murale, porta pellicola
Wand-Folien-Abreißgerät
Dérrouleur de film mural
Soporte de pared para film

art.	l. cm.
42513-30	30
42513-45	45

Roll max ø cm 13. – Rotolo ø max. cm 13.



PP

Additional plate stand

Anello distanziatore
Gestell für Zusatzteller
Support assiette supplémentaire
Soporte distancidor

art.	Ø cm.	h.
47605-23	19-21	6



PP

Plate cover

Copripiatto
Tellerlocke
Cloche
Cubreplatos

art.	Ø cm.	h.
47603-25	25	6,5
47603-27	27	6,5
44998-31	31	6,5



PC

Plate cover

Copripiatto
Tellerlocke
Cloche
Cubreplatos

art.	Ø cm.	h.
44997-22	21	6,8
44997-24	23	6,8
44997-26	26	6,8
44997-28	28	6,8



SS

Plate cover

Copripiatto
Tellerlocke
Cloche
Cubreplatos

art.	Ø cm.	h.
41683-26	26,5	4,3



SS

Funnel

Imbuto
Trichter
Entonnoir
Embudo

art.	Ø cm.
42562-12	12
42562-14	14
42562-16	16
42562-18	18
42562-20	20
42562-25	25
42562-30	30



PP

Funnel

Imbuto
Trichter
Entonnoir
Embudo

art.	Ø cm.
47604-08	8
47604-10	10
47604-12	12
47604-15	15
47604-18	18
47604-20	20
47604-24	24
47604-30	30



PP

Measuring jug

Caraffa graduata
Messbecher
Pichet gradué
Jarra de medidas

art.	Ø cm.	h.	lt.
47608-02	19	12	2,2



PP

Measuring jug

Caraffa graduata
Messbecher
Pichet gradué
Jarra de medidas

art.	Ø cm.	h.	lt.
47606-02	8,5	10,0	0,25
47606-05	10,5	10,5	0,50
47606-10	12,5	14,5	1,00
47606-20	13,5	17,0	2,00
47606-30	15,5	21,0	3,00
47606-50	19,0	24,0	5,00



PP

Measuring jug

Caraffa graduata
Messbecher
Pichet gradué
Jarra de medidas

art.	Ø cm.	h.	lt.
47607-10	12,5	14,5	1
47607-20	13,5	17,0	2

Lt. and ml. scale. Heat resistant up to 95°C.
Scala in lt e ml. Resistente fino a 95°C.



SS

Graduated measure jug

Misurino graduato
Messbecher, graduert
Mesure graduée
Jarra de medidas

art.	Ø cm.	h.	lt.
42581-01	7,5	5	0,1
42581-03	10,0	7	0,3
42581-05	11,5	11	0,5
42581-10	15,0	13	1,0
42581-15	15,5	15	1,5
42581-20	17	19	2,0



SS

Measuring spoons, 4 pcs

Misurini set 4 pz
Messlöffel Set 4-tlg.
Cuillères à mesurer 4 pcs
Cucharas medidoras 4 pz

art.	ml.
42615-04	1-2,5-5-15



SS

Measuring cups, 4 pcs

Misurini set 4 pz
Messlöffel Set 4-tlg.
Cuillères à mesurer 4 pcs
Cucharas medidoras 4 pz

art.	ml.
42616-04	60-80-125-250



SS

Lever dispenser

Dosatore
Hebeldosierspender
Distributeur à manette
Dispensador

art.	Ø cm.	h.
41528-21	21	22,5
41528-22	22	18,0

Suitable for 5 kg bucket. – Per bidone da kg 5.



AY

Dispenser

Dosatore
Dosierspender
Doseur
Dispensador

art.	ml.
47609-02	250
47609-03	350
47609-09	950
47609-13	1350



AY

Dispenser

Dosatore
Dosierspender
Doseur
Dispensador

art.	ml.
47609-04	375
47609-07	750
47609-12	1250
47609-16	1650



PE

Squeeze bottle

Flacone dosatore
Quetschflasche
Flacon doseur
Frasco dosificador

art.	ml.	col.
41526-R1	240	●
41526-R2	360	●
41526-R3	720	●



PE

Squeeze bottle

Flacone dosatore
Quetschflasche
Flacon doseur
Frasco dosificador

art.	ml.	col.
41526-B1	240	○
41526-B2	360	○
41526-B3	720	○



PE

Squeeze bottle

Flacone dosatore
Quetschflasche
Flacon doseur
Frasco dosificador

art.	ml.	col.
41526-G1	240	●
41526-G2	360	●
41526-G3	720	●



PE

Squeeze bottle, 4 pcs

Flacone dosatore, 4 pz
Quetschflasche, 4 Stk
Flacon doseur, 4 pcs
Frasco dosificador, 4 pz

art.	Ø cm.	h.	ml.
41526-01	3	8,5	30



Squeeze bottle, 4 pcs
Flacone dosatore, 4 pz
Quetschflasche, 4 Stk
Flacon doseur, 4 pcs
Frasco dosificador, 4 pz

art.	Ø cm.	h.	ml.
41526-02	3,5	9,5	50



Squeeze bottle
Flacone dosatore
Quetschflasche
Flacon doseur
Frasco dosificador

art.	Ø cm.	h.	ml.
41526-05	5,0	18	200
41526-06	5,5	19	350



Triple nozzle squeeze bottle
Flacone dosatore, triplo ugello
Quetschflasche mit Dreifachdüse
Flacon doseur à trois becs
Frasco dosificador 3 boquillas

art.	ml.	col.
41520-08	235	○
41520-12	355	○
41520-16	470	○
41520-24	700	○



Decorating spoons 2 pcs
Cucchiai decorazione 2 pz
Dekoration-Löffel 2 Stk
Cuillères pour décorer 2 pcs
Cucharas para decoración 2 pz

art.	l. cm.
47831-02	19-23



Flour scoop
Sessola tonda
Mehlschaufel
Pelle à farine
Librador

art.	lt.
42609-10	0,10
42609-15	0,40
42609-20	1,00
42609-23	1,70
42609-25	2,80



Flour scoop
Sessola
Mehlschaufel
Pelle à farine
Librador

art.	cm.	lt.
17610-01	20x7	0,10
17610-02	27,5x9,5	0,25
17610-05	32,5x12	0,50
17610-10	39x15	1,00



Flour scoop
Sessola
Mehlschaufel
Pelle à farine
Librador

art.	cm.	lt.
12940-02	27,5x9,5	0,25
12940-05	32,5x12	0,50
12940-10	39x15	1,00
12940-20	48x18	2,00
12940-25	50x19,5	2,50



Sieve with spare gauzes
Setaccio rete intercambiabile
Sieb mit auswechselbarem Siebeinsatz
Tamis avec toiles de rechange
Cernidor con red intercambiabile

art.	Ø cm.	Ø mm.
42590-01	30	*1,4
42590-02	30	*1,1
42590-03	30	*0,9

*Mesh. – Rete.



SS

Spare gauzes

Rete intercambiabile
Auswechselbarem Siebeinsatz
Toiles de rechange
Red intercambiabile

art.	Ø cm.	Ø mm.
42590R01	30	*1,4
42590R02	30	*1,1
42590R03	30	*0,9

*Mesh. – Rete.



SS

Bread sieve

Setaccio pane
Brotsieb
Tamis à pain
Cernidor para pan

art.	Ø cm.	h.
12604-22	22	8
12604-30	30	8
12604-34	34	8
12604-40	40	8

8 eye per inch. – 8 fori per 2,5 cm2.



SS

Flour sieve

Setaccio farina
Mehlsieb
Tamis à farine
Cernidor para harina

art.	Ø cm.	h.
12605-22	22	8
12605-30	30	8
12605-34	34	8
12605-40	40	8

20 eye per inch. – 20 fori per 2,5 cm2.



SS

Sieve

Setaccio infarina pesce
Sieb
Tamis
Cernidor

art.	Ø cm.	h.
12606-30	30	8
12606-34	34	8

4 eye per inch. – 4 fori per 2,5 cm2.



SS

Sieve

Setaccio rete pasticceria
Sieb
Tamis
Cernidor

art.	Ø cm.	h.
12607-22	22	8
12607-30	30	8
12607-34	34	8

10 eye per inch. – 10 fori per 2,5 cm2.



SS

Kitchenbowl, with handles

Bacinella conica con maniglie
Schüssel mit Griffen
Bassine conique avec anses
Caldero cónico con asas

art.	Ø cm.	h.	lt.
11955-32	32	16,0	8,8
11955-36	36	18,5	12,8
11955-40	40	20,0	17,0
11955-45	45	22,5	24,5
11955-50	50	24,0	32,5



SS

Conical colander

Colapasta tronco conico
Gemüseseiher
Passoire à légumes
Colador cónico

art.	Ø cm.	h.	lt.
11930-24	24	12,0	3,5
11930-28	28	14,0	5,5
11930-32	32	16,0	8,8
11930-36	36	18,5	12,8
11930-40	40	20,0	17,0
11930-45	45	22,5	24,5
11930-50	50	24,0	32,5



SS

Conical colander

Colapasta tronco conico
Gemüseseiher
Passoire à légumes
Colador cónico

art.	Ø cm.	h.	lt.
11927-24	24	12,0	3,5
11927-28	28	14,0	5,5
11927-32	32	16,0	8,8
11927-36	36	18,5	12,8
11927-40	40	20,0	17,0
11927-45	45	22,5	24,5
11927-50	50	24,0	32,5



SS

Hemispherical mixing bowl

Bacinella semisferica
Schüssel
Bassine demi-ronde
Caldero semiesférico

art.	Ø cm.	lt.
11957-20	20	2,0
11957-25	25	3,7
11957-30	30	7,2
11957-35	35	10,5
11957-40	40	15,6



NSF
SS

Kitchenbowl low

Bacinella conica bassa
Schüssel, flach
Bassine
Caldero cónico

art.	Ø cm.	h.	lt.
12582-13	13,2	6,0	0,5
12582-17	16,5	7,5	1,0
12582-22	22,0	7,5	2,0
12582-24	24,0	9,5	3,0
12582-32	30,5	11,5	6,0
12582-34	32,5	14,0	8,0
12582-38	38,0	13,5	11,0
12582-40	40,0	15,0	14,0



NSF
SS

Kitchenbowl high

Bacinella conica alta
Tiefe Schüssel
Bassine haute
Caldero cónico alto

art.	Ø cm.	h.	lt.
12580-11	11,7	7,0	0,5
12580-17	15,5	9,0	1,0
12580-21	19,0	11,5	2,0
12580-24	22,0	12,0	3,0
12580-29	27,0	13,5	5,0
12580-30	29,0	15,0	6,0
12580-31	30,5	17,0	8,0
12580-36	35,5	18,5	11,0
12580-40	40,0	20,0	17,0
12580-45	45,0	22,0	25,0
12580-50	50,0	24,0	33,0



PA+
plus

Conical colander

Colatutto tronco conico
Gemüsesieher
Passoire à légumes
Colador cónico

art.	Ø cm.	h.	lt.
12950-32	32	16	8
12950-40	40	20	12



Conical colander, aluminium

Colapasta tronco conico, alluminio
Gemüsesieher, Aluminium
Passoire à légumes, alu
Colador cónico, aluminio

art.	Ø cm.	h.	lt.
16927-32	32	16,0	8,8
16927-36	36	18,5	12,8
16927-40	40	20,0	17,0
16927-45	45	22,5	24,5
16927-50	50	24,0	32,5



SS

Colander

Colapasta con cerchio
Gemüsesieher
Passoire à légumes
Colador con base

art.	Ø cm.	h.	lt.
11928-32	32	18,0	9,5
11928-36	36	19,0	12,0
11928-40	40	21,0	14,5



SS

Strainer

Colapasta semisferico
Stielsieb
Passoire hémisphérique
Colador semiesférico

art.	Ø cm.	h.	lt.
11926-22	22	12	2,7
11926-26	26	14	4,0



SS

Strainer

Colapasta
Stielsieb
Passoire
Colador

art.	Ø cm.	h.	lt.
11924-18	18	11	2,8
11924-20	20	12	3,6
11924-22	22	13	5,0
11924-24	24	14	6,5
11924-28	28	15	9,3



Strainer, aluminium

Colapasta, alluminio
Stielsieb, Aluminium
Passoire, alu
Colador, aluminio

art.	Ø cm.	h.	lt.
16924-20	20	11	3,2
16924-24	24	13	6,0
16924-28	28	15	9,3



PP

Strainer

Colapasta
Stielsieb
Passoire
Colador

art.	Ø cm.
47610-22	22
47610-26	26
47610-30	30



PP

Strainer
Colapasta
Stielsieb
Passoire
Colador

art.	Ø cm.
47610-18	18



PE

Graduated bucket
Secchio graduato
Eimer mit Skala
Seau gradué
Cubo con medidas

art.	Ø cm.	h.	lt.
49889-09	27	26,2	9
49889-12	29	29,0	12
49889-15	31	30,8	15

With spout. – Con becco.



SS

Graduated bucket
Secchio graduato
Eimer mit Skala
Seau gradué
Cubo con medidas

art.	Ø cm.	h.	lt.
41960-08	28,5	20,5	8
41960-10	30,0	25,0	10
41960-12	31,0	27,0	12
41960-15	32,5	31,0	15



SS

Graduated bucket with bottom ring
Secchio graduato con base
Eimer mit Fuss u. Skala
Seau gradué avec base
Cubo con medidas y base

art.	Ø cm.	h.	lt.
41961-10	30,0	26,5	10
41961-12	31,0	28,5	12
41961-15	32,5	32,5	15



SS

Lid for bucket
Coperchio per secchio
Deckel für Eimer
Couvercle pour seau
Tapa para cubo

art.	Ø cm.
41962-10	30,0
41962-12	31,0
41962-15	32,5



PE

Mixing bowl
Bacinella tonda
Schüssel
Bassine ronde
Caldero semiesférico

art.	Ø cm.	h.	lt.
47600-16	16	7,0	0,9
47600-20	20	8,5	1,6
47600-24	24	10,0	2,8
47600-28	28	11,0	4,5
47600-32	32	12,5	6,5
47600-36	36	14,0	10,0
47600-40	40	15,5	13,5



PP

Mixing bowl
Bacinella tonda
Schüssel
Bassine ronde
Caldero semiesférico

art.	Ø cm.	h.	lt.
47611-01	19,0	7,9	1,0
47611-03	24,0	11,5	2,5
47611-05	28,0	13,5	4,5
47611-06	32,5	14,7	6,0
47611-09	36,0	16,5	9,0
47611-13	40,0	18,5	13,0



PP

Lid
Coperchio
Deckel
Couvercle
Tapa

art.	Ø cm.
47611-11	19,0
47611-14	24,0
47611-15	28,0
47611-16	32,5
47611-19	36,0
47611-23	40,0



SS

Mixing bowl
Bastardella semisferica
Schnees Schlagkessel
Bassine hémispherique
Caldero con asas

art.	Ø cm.	h.	lt.
11952-22	22	12,0	2,7
11952-26	26	14,0	4,0
11952-32	32	18,0	9,5
11952-36	36	20,5	14,0
11952-40	40	21,5	18,0



SS

Mixing bowl without handles

Bastardella senza maniglie
Schneeschlackessel ohne Griffe
Bassine hémispherique sans anses
Caldero sin asas

art.	Ø cm.	h.	lt.
11951-22	22	12,0	2,7
11951-26	26	14,0	4,0
11951-32	32	18,0	9,5
11951-36	36	20,5	14,0
11951-40	40	21,5	18,0



SS

Foot for mixing bowl

Base per bastardella
Fuss für Schneeschlackessel
Base pour bassine hémispherique
Base para caldero

art.	Ø cm.	for/per Ø
11953-16	16	22-26
11953-22	22	32-36-40



SS

Kettle for mixing machines

Bacinella per planetaria
Schlagmaschinenkessel
Bol pour mélangeurs
Caldero para batidera

art.	Ø cm.	h.	lt.
11954-26	26	20,0	10,0
11954-30	30	25,0	16,0
11954-32	32	30,0	20,0
11954-36	36	28,5	25,0
11954-37	36	35,0	32,0
11954-40	40	35,5	40,0



SS

Kitchenbowl with handle

Tazzone con manico
Schlagschüssel mit Rohrstiel
Bol avec manche
Cazo bombeado

art.	Ø cm.	h.	lt.
41916-10	15	8,0	1,0
41916-15	17	9,0	1,2
41916-20	19	10,0	2,0



Manual salad spinner

Centrifuga manuale per verdura
Salatschleuder
Essoreuse manuelle à salade
Centrifugadora de ensalada

art.	Ø cm.	h.	lt.
49888-10	33	43	12
49888-20	43	52	25



SS

Soup strainer

Colino a rete
Suppensieb
Passe-bouillon
Colador a red

art.	Ø cm.	l. cm.
12622-07	7	12
12622-10	10	12
12622-12	12	17
12622-14	14	17
12622-16	16	17
12622-18	18	17
12622-20	20	17
12622-23	23	27
12622-26	26	27



SS

Strainer, double mesh

Colapasta doppia rete
Passiersieb, doppelnetz
Passoire, maille double
Colador doble red

art.	Ø cm.	l. cm.
12633-16	16	17
12633-18	18	17
12633-20	20	17
12633-23	23	27
12633-26	26	27



SS

Strainer

Colatutto
Sieb
Passoire
Colador multiuoso

art.	cm.	l. cm.
12630-22	22x18	19



NEW

SS

Strainer

Colino
Sieb
Passoire
Colador

art.	Ø cm.
41570-10	8



SS

Strainer, reinforced
Colapasta rinforzato
Grossküchensieb mit Verstärkung
Passoire renforcé
Colador reforzado

art.	Ø cm.	l. cm.
12635-23	23	27
12635-26	26	27
12635-30	30	44
12635-35	35	44



SS

Vegetable sieve
Passaverdura
Passiergerät
Mini hache-tout
Pasa verdura

art.	Ø cm.
12638-20	20



SS

Strainer
Colatutto gigante
Grossküchensieb
Passoire géant
Colador multiuso gigante

art.	Ø cm.	l. cm.
12636-32	32	60



SS

Chinese colander
Cornetto cinese
Spitzsieb
Passoire chinois
Colador chino

art.	Ø cm.
41925-14	14
41925-16	16
41925-18	18
41925-20	20
41925-22	22
41925-24	24
41925-26	26



SS

Chinese colander stand
Supporto per cornetto cinese
Träger für Spitzsieb
Support chinois
Soporte para colador chino

art.	Ø cm.	h.
41933-18	18	28



SS

Colander with wire gauze
Cornetto cinese a rete
Gazensieb
Chinois à gaze
Colador chino a red

art.	Ø cm.
11929-20	20
11929-24	24



SS

Chinese colander with wire protection
Cornetto con protezione
Spitzsieb mit Verstärkung
Chinois à gaze avec renfort
Colador chino con protección

art.	Ø cm.
11932-20	20
11932-24	24



SS

Chinese soup strainer
Colino conico a rete
Suppen-Spitzsieb
Passe-bouillon chinois
Colador cónico a red

art.	Ø cm.
41931-08	8
41931-14	14
41931-16	16
41931-18	18



Bouillon cloth
Panno passabrodo
Bouillonstoffsieb
Etamine passe-bouillon
Paño para pasar caldo

art.	cm.	U. Pack
41932-05	87x70	5

Twisted cotton cloth with seam.
Tela di cotone ritorto, orlata.



ABS

Rice scoop

Porzionatore
Reis-Portionierer
Portionneur
Racionador

art.	h.	gr.
42653-04	4,5	120-130



PA+
plus

Portion ring

Anello per impiattare
Portionierspeisering
Cercle portionneur
Anillo porcionador

art.	Ø cm.	h.
12943-03	3	3,5
12943-05	5	3,5
12943-07	7	3,5
12943-08	8	3,5
12943-10	10	3,5
12943-12	12	3,5



PA+
plus

Portion ring

Anello per impiattare
Portionierspeisering
Cercle portionneur
Anillo porcionador

art.	Ø cm.	h.
12944-03	3	3,5
12944-05	5	3,5
12944-07	7	3,5
12944-08	8	3,5
12944-10	10	3,5
12944-12	12	3,5



PP

Bag clip

Clip chiudi sacco
Verschluss-Clip
Clip ferme sachet
Pinza cierra bolsas

art.	l. cm.	pcs/pz
42908-14	14	3
42908-24	24	1

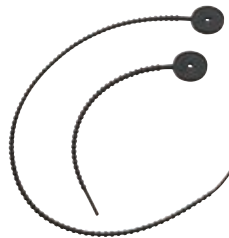

Foodloops, silicone, 6 pcs

Laccetti da cucina, silicone, 6 pz
Silikonbänder, 6 Stk
Lacets de cuisson, silicone, 6 pcs
Lazos de silicona de cocina, 6 pz

art.	l. cm.
51595B44	22
51595B45	53



Presse canard, bronze

Presse canard, bronzo
Presse canard, Bronze
Presse à canard, bronze
Prensador para canard, bronze

art.	h.	Kg.
49845-01	52	16

Tinned. – Stagnato.



SS

Octopus-press

Pressapolipo
Krake-Press
Presse à poulpe
Prensador para pulpo

art.	Ø cm.	h.
49760-00	10,5	20,5



SS

Mini-guitar

Mini-chitarra
Mini-Guitare
Mini-guitare
Mini guitarra

art.	cm.	Kg.
49839-00	45x23x15	4,9

For products with tender and homogeneous consistency. Cut width 14,5 cm, thickness 5 mm.
Per prodotti teneri ma di consistenza omogenea.
Larghezza taglio 14,5 cm, spessore 5 mm.



SS

Cube cutter
Taglia cubi
Würfel-Schneidergerät
Coupe-cubes
Cortador en dados

art.	cm.	Kg.
49821-08	35,5x26x66	4

Dice thickness 8 mm. – Spessore taglio 8 mm.



SS

Tomato cutter
Affetta pomodori
Tomatenschneidergerät
Coupe-tomates
Cortador tomates

art.	cm.	Kg.
49837-05	30x14x18	2

Slice thickness 5,5 mm. – Spessore taglio 5,5 mm.



ABS

Tomato cutter
Affetta pomodori
Tomatenschneidergerät
Coupe-tomates
Cortador tomates

art.	cm.	Kg.
49837-01	28,5x13x16	0,8

Slice thickness 5,5 mm. – Spessore taglio 5,5 mm.



SS

Vegetable cutter
Taglia verdure
Gemüseschneider
Machine à tourner les légumes
Cortador de verduras

art.	cm.	Kg.
49842-00	21x17,5x19	3,2

To make chateau potatoes, cocottes and fondants lenght from 4 to 8 cm. 3 position adjustable blade. – Per patate chateau, cocotte e fondenti di lunghezza da 4 a 8 cm. Lama con 3 regolazioni. di taglio.



SS

Fruit cutter
Trancia spicchi
Früchteschneider
Coupe-ruits
Cortador tomates

art.	cm.	Kg.
49838-08	38x26x58	3,3

8 wedges, for vegetables and fruits without stone. – 8 spicchi, per ortaggi e frutta senza nocciolo.



Apple corer/wedger set of blades
Set lame levatorisolo e trancia spicchi
Apfelentkerner-/Schneidmesser
Lames évideur/coupe-pommes
Saca corazón y cortador para manzanas

art.
49838-98



Epoxy peeler on stand
Pela carote/verdure supporto epossidico
Gemüseschäler, Epoxidfuß
Éplucheur sur pied epoxy
Pelador sobre pie epoxy

art.	cm.	Kg.
49819-00	21,5x14x51	1,8

Equipped with ø 4,5 cm. – Dotazione ø 4,5 cm.

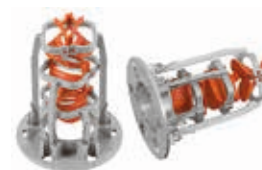

Additional peeling heads
Accessori opzionali per pela verdure
Schälkopf-Zusatzteile
Têtes supplémentaires pour éplucheur
Cabezas suplementarios para pelador

art.	Ø cm.
49819-01	4,5
49819-02	6,0



SS

Pineapple-peeler/corer

Pela/svuota ananas
Ananasschälmaschine
Epluche-ananas
Pelador de piña

art.	cm.	Kg.
49818-00	45x39x72	18

Blade and pusher ø 89 mm.

Lama e pressatore ø 89 mm.



Additional pushers and blades

Pressatori e lame opzionali
Zusätzliche Presse und Messer
Poussoirs et couteaux supplémentaires
Empujador y cuchilla suplementarios

art.	Ø cm.
49818-AC	7,4
49818-AD	7,4
49818-AE	10,2
49818-AF	10,2

AC, AE: blade - AD, AF: pusher

AC, AE: lama - AD, AF: pressatore



SS

Pineapple slicer

Taglia ananas
Ananasteiler
Coupe-ananas en rondelle
Cortador de piña en rondajas

art.	Ø cm.	l. cm.
48218-00	2,5	24



SS

Pineapple coring tool

Svuota ananas
Ananasausstecher
Vide ananas
Saca corazón de piña

art.	Ø cm.	l. cm.
48280-10	2,5	24



Electric peeler

Pelatrice elettrica
Elektr. Schälmaschine
Eplucheur électrique
Pelador eléctrico

art.	cm.	Kg.
49750-00	25x16x21,5	2



Professional apple peeler

Pela mele professionale
Profi-Apfelschäler
Pèle-pommes, professionnel
Pelador de manzanas, profesional

art.	cm.	Kg.
49834-00	32x14x10	1,9



Orange peeler with screw

Pela arance con morsetto
Orangenschäler, Tischklemme
Pèle-orange, socle serre-joint
Pelador de naranjas, fijación brida

art.	cm.
49817-00	30x10x15



Apple peeler with screw

Pela mele con morsetto
Apfelschäler, Tischklemme
Pèle-pommes, socle serre-joint
Pelador de manzanas, fijación brida

art.	cm.
49835-00	30x10x17



Apple peeler, vacuum-power base

Pela mele con ventosa
Apfelschäler, Vakuum-Fuss
Pèle-pommes, socle vacuum
Pelador de manzanas, fijación ventosa

art.	cm.
49836-00	30x10x13



SS

Potato twist cutter

Tagliaverdure ghirlanda
Kartoffeln-Spiralschneider
Machine à brochette
Coratador de verduras

art. cm. Kg.
49843-00 33x13x45 3,4

Slice thickness 2,5 mm. – Spessore taglio 2,5 mm.



SS

Apple corer/wedger

Trancia spicchi per mela
Apfelentkerner-/Schneider
Lames évideur/coupe-pommes
Cortador y descoronador manzanas

art. Ø cm.
48289-10 10



SS

Egg wedger

Taglia uova
Eierteiler
Tranche-oeufs
Cortahuevos

art. Ø cm. l. cm.
42597-00 6,5 21



SS

Egg knocker

Apriuovo
Eierköpfer
Toque oeuf
Abridor de huevos

art. Ø cm. l. cm.
42595-01 3,2 11



Egg-slicer, aluminum

Taglia uova, alluminio
Eierteiler, Aluminium
Tranche-oeufs rondelle, aluminium
Cortahuevos guitarra, aluminio

art. cm.
42588-01 13,5x8x4,5



Egg-slicer duo

Taglia uova doppio
Eierteiler 2 in 1
Tranche-oeufs 2 emplacements
Cortahuevos doble

art. cm.
42588-00 21x8x4,5



Egg container

Contentitore per uova
Eier-Behälter
Porte-oeufs
Contenedor para huevos

art. cm.
47093-24 30x21,5x6,5



AY

Egg container

Contentitore per uova
Eier-Behälter
Porte-oeufs
Contenedor para huevos

art. cm.
44947-07 15x20x5



SS

Egg rings 2 pcs

Anelli per uova 2 pz
Eierringe, 2 Stk
Ronds à oeufs, 2 pcs
Anillos para huevos, 2 pz

art. Ø cm. h.
42596-02 8 1,5



Egg ring, non stick

Anello per uova, antiaderente
Eierring, beschichtet
Rond à oeufs, anti-adhésif
Anillo para huevos, antiadherente

art. Ø cm. h.
42650-10 10 1,5



Egg ring, non stick

Anello per uova, antiaderente
Eierring, beschichtet
Rond à oeufs, anti-adhésif
Anillo para huevos, antiadherente

art. Ø cm. h.
42650-11 11 1,5



SS

Mushroom cutter

Taglia funghi
Pilze-Teiler
Tranche-champignons
Cortador de hongos

art.	Ø cm.	l. cm.
42598-00	7,6	20,7



SS

Avocado peeler and slicer

Pela/taglia avocado
Avocadoschäler-/Teiler
Pèle et tranche avocat
Pelador y cortador de aguacete

art.	l. cm.
48286-62	18,5



SS

Mango cutter

Taglia mango
Mangoteiler
Coupe mangue
Cortador de mangos

art.	cm.	h.
48286-66	10,5x10	17,5



SS

Large vegetable slicer

Pelaverdure
Gemüeschäler
Eplucheur à légumes
Pelador de verduras

art.	cm.
48286-64	22x10



Potato peeler

Pelapatate
Sparschäler
Eplucheur
Pelador de patatas

art.	cm.
42589-00	5x4



SS

Potato ricer with 3 discs

Schiacciapatate, 3 griglie
Kartoffelpresse, 3 Roste
Presse-purée, 3 grilles
Pasapurés, 3 discos

art.	Ø cm.	cm.
42566-03	8,5	30x10x11

Discs/Dischi: ø 2,4 - 4,4 - 6,5 mm.



SS

French fry cutter

Taglia patate
Kartoffelschneidgerät
Coupe-frites
Cortador de patatas fritas

art.	cm.	Kg.
49832-10	24x44x34	11

Cutting knife/Quadro di taglio: 10 mm.



SS

French fry cutter

Taglia patate
Kartoffelschneidgerät
Coupe-frites
Cortador de patatas fritas

art.	cm.	Kg.
49832-02	26x9x12,5	1,2

Cutting knives/Quadri di taglio: 9x9 - 12x12 mm.



Herb scissors 5 blades

Forbice per erbe, 5 lame
Kräuterschere 5 Klingen
Ciseaux à herbes 5 lames
Tijeras hierbas 5 cuchillas

art.	l. cm.
18277-00	10



Cheese rotary grater

Grattugia formaggio rotatoria
Drehe-Käse-Raffel
Frisette à fromage
Ralladora giratoria para queso

art.	Ø cm.	h.
48281-22	22	16

Wood base. – Base legno.



Rotary grater cover

Cloche per grattugia rotatoria
Käse-Raffel-Haube
Cloche à frisette
Tapa para ralladora

art.	Ø cm.	h.
48281-23	15,5	11



SS

Tortillas wedger

Taglia tortillas
Tortillasteiler
Coupe-tortillas
Corta tortillas

art.	Ø cm.
42599-06	25
42599-08	25

Wedges/Spicchi: 6 - 8.



Grater, automatic

Grattugia automatica
Reibe, automatisch
Râpe automatique
Rallador automático

art.	cm.
48295-10	20x5,4

Hermetic container, removable, with lid, 2 blades.
Ideal for cheese, nuts, chocolate, etc.
Recipiente ermetico, removibile, con cop., 2 lame.
Ideale per formaggio, noci, cioccolato, ecc.



SS

Cheese wire cutter

Lira per formaggi
Käse Drahtschneider
Lyre à fromage
Lira para quesos

art.	cm.
48282-21	20,5x26,7



SS

Garlic press

Spremiaglio
Knoblauchpresse
Presse-ail
Prensador de ajo

art.	Ø cm.
42565-00	2,7



Olive seed remover, chromed

Snocciolatore, cromato
Olivenentsteiner, verchromt
Dénoyauteur, chromé
Quita pepa/hueso, cromado

art.	l. cm.
42563-00	17



Cherry core stripper

Snocciolatore
Kirschenentsteiner
Dénoyauteur de cerises
Quita pepa/hueso

art.	Ø cm.	h.
42563-44	10	34

Equipped with 7 interchangeable blades.
Dotato di 7 lame intercambiabili.



SS

Mandoline

Mandolino
Gemüsehobel Mandoline
Mandoline
Mandolina

art.	cm.	Kg.
49829-11	39x12,5x5,5	1,7

Equipped with 7 interchangeable blades.
Dotato di 7 lame intercambiabili.



SS

Slicer Mandoline, Grand Gourmet

Mandolino Grand Gourmet
Gemüsehobel Grand Gourmet
Mandoline Grand Gourmet
Mandolina Grand Gourmet

art.	cm.	Kg.
49830-60	40x12x28	1,6

38 blades, 10 mm. – 38 lame, 10 mm.



SS

Mandoline

Mandolino
Gemüsehobel Mandoline
Mandoline
Mandolina

art.	cm.	Kg.
49752-00	33,5x11x2,3	0,6

3 interchangeable blades of 2-3-6 mm.
3 lame intercambiabili da 2-3-6 mm.



ABS

Japanese Mandoline slicer

Mandolino giapponese
Japanese Gemüsehobel
Mandoline japonaise
Mandolina japonesa

art.	cm.	Kg.
49753-06	11x31,5x3	0,3
49753-09	15x35x3,3	0,5

1 plain blade and 3 blades of 1-2-3 mm.
1 lama liscia e 3 lame da 1-2-3 mm.



SS

Cutter/corer

Intaglia verdure
Ausstechforme
Découpoir
Sacabocados

art.	cm.
48286-70	3,7x8,5x9

Cutting ø 3,4 cm. – Taglio ø 3,4 cm.



SS

Cutter turn'up

Tagliaverdura turn'up
Ausstechforme Turn'Up
Découpoir pour fonds à garnir
Descorazonador-vaciador turn'up

art.	Ø cm.	h.
48285-04	4	14,5
48285-05	5	14,5



Spiral vegetable slicer, plastic

Taglia verdure, plastica
Gemüeschneider, Kunststoff
Coupe légumes, plastique
Cortador de verduras, plástico

art.	Ø cm.	h.
49825-05	8	15



Spiral vegetable slicer 3-blade, plastic

Taglia verdure 3 lame, plastica
 Gemüseschneider, Kunststoff
 Coupe légumes, plastique
 Cortador de verduras, plástico

art. cm.
 49827-99 30x14x22

3 interchangeable s/s blades (3 - 6 mm. and 1 straight blade for ribbon cuts). Ideal for julienne cuts, chips, spiral shapes, rings and plain slices of vegetables and fruits. – 3 lame inox intercambiabili (3 - 6 mm. e 1 lama dritta per taglio a nastro). Ideale per julienne, chips, riccioli, anelli e fette sottili di verdura e frutta.



Turning slicer 4-blade, plastic

Taglia verdure 4-lame, plastica
 Gemüseschneider, Kunststoff
 Coupe légumes, plastique
 Cortador de verduras, plástico

art. cm.
 49826-99 15,5x25x15

**4 blades: 2,5 - 3x3 - 4x6 - 1,2x2 mm.
 4 lame: 2,5 - 3x3 - 4x6 - 1,2x2 mm.**



Strip slicer

Taglia verdure
 Gemüseschneider
 Coupe-lanières
 Cortador de verduras japonés

art. cm. Kg.
 49823-00 20x20x25 1,9

Width of cut 15 cm. Max vegetables length 11 cm. and ø 17 cm. – Larghezza taglio 15 cm. Lunghezza max verdura 11 cm. e ø 17 cm.



Strip slicer

Taglia verdure
 Gemüseschneider
 Coupe lanière
 Cortador de verduras

art. cm.
 49823-89 28x25x16,5

**Width of cut 13 cm. Thickness 0,5 mm.
 Larghezza taglio 13 cm. Spessore 0,5 mm.**



Strip & spaghetti slicer

Taglia verdure
 Gemüseschneider
 Coupe lanière et spaghetti
 Cortador de verduras japonés

art. cm.
 49823-99 28x25x16,5

**Width of cut 13 cm. 2 blades 130x0,5 - 1x1,2 mm.
 Larghezza taglio 13 cm. 2 lame 130x0,5 - 1x1,2 mm.**



Vegetable cutter LE ROUET GOURMET

Taglia verdure
Gemüseschneider
Coupe légumes
Cortador de verduras

art.	cm.	Kg.
49827-03	13,5x36x24,3	2,4

Cutting blocks 1-2-4 mm. Cutting thickness blade guirlandes 1>4 mm. – Pettini taglio 1-2-4 mm. Spessore taglio lama guirlandes 1>4 mm.

ABS

SS



Vegetable decorating tool

Decora verdure, spirale
Dekoriergerät
Decò spiral
Decorador espiral

art.	Ø cm.	l. cm.
48283-00	1,3	23,5
48283-01	1,0	23,5
48283-02	0,7	23,5

SS



Vegetable decorating tool

Decora verdure, spirale
Dekoriergerät
Decò spiral
Decorador espiral

art.	l. cm.
48283-03	23,5
48283-04	23,5
48283-05	23,5

SS



Vegetable decorating tool

Decora verdure, ghirlanda
Dekoriergerät
Decò guirlande
Decorador guirlanda

art.	l. cm.
48284-00	15,5

SS



Decorations tools 18 pcs

Attrezzi decoro, 18 pz
Dekoriersatz, 18-Tlg.
Outils de décor 18 pcs
Herramientas decoración 18 pz

art.
48286-03

SS



Decorations tools 22 pcs

Attrezzi decoro, 22 pezzi
Dekoriersatz, 22-Tlg.
Outils de décor 22 pcs
Herramientas decoración 22 pz

art.	cm.
48286-13	38,5x29

SS



Fluted chisel set 4 pcs

Attrezzi decoro kit 4 pz
Dekoriersatz, 4-Tlg.
Gouges cannelées 4 pcs
Cinceladores estriados 4 pz

art.
48286-05

SS



SS

Decoration tools 45 pcs
 Attrezzi decoro, 45 pezzi
 Dekoriersatz, 45-Tlg.
 Outils de décor 45 pcs
 Herramientas decoración 45 pz

 art. cm.
 48286-18 40x32x10,5



SS

Thai knife
 Stiletto thailandese
 Thai-Messer
 Stylet thai
 Cuchillo thai

 art. l. cm.
 48286-08 16



SS

Decoration tools 26 pcs
 Attrezzi decoro, 26 pezzi
 Dekoriersatz, 26-Tlg.
 Outils de décor 26 pcs
 Herramientas decoración 26 pz

 art. cm.
 48286-01 32,5x27,5



Ice knife
 Coltello ghiaccio
 Eis-Messer
 Couteau à glace
 Cuchillo para hielo

 art. l. cm. Kg.
 47885-01 25 0,12



Chisel V shape
 Scalpello ghiaccio a V
 Eismeissel
 Ciseau à glace
 Cinsel a V para hielo

 art. l. cm. Kg.
 47885-02 31,5 0,28



Chisel flat medium
 Scalpello ghiaccio 3 lati smussati
 Eismeissel
 Ciseau à glace
 Cinsel para hielo

 art. l. cm. Kg.
 47885-03 50 0,45



Chisel flat big
 Scalpello ghiaccio 1 lato smussato
 Eismeissel
 Ciseau à glace
 Cinsel para hielo

 art. l. cm. Kg.
 47885-04 74,5 0,78



Ice chisel set 4 pcs

ScalPELLI ghiaccio 4 pz
Eismeissel 4 Stk
Ciseaux à glace 4 pcs
Cinseles para hielo 4 piezas

art.

47885-05



Butter churn

Mantecatore per burro
Butterfaß
Baratte à beurre
Mantquera

art.

cm.

lt.

48294-01 11,5x11,5x40 1,6



Butter mold

Stampo per burro
Butterform
Moule à beurre
Molde para mantequilla

art.

cm.

gr.

48294-02 12,2x6,6x4,3 80



Butter mold

Stampo per burro
Butterform
Moule à beurre
Molde para mantequilla

art.

cm.

gr.

48294-03 15,8x9x5 125



Butter mold

Stampo per burro
Butterform
Moule à beurre
Molde para mantequilla

art.

cm.

gr.

48294-04 21x9,4x5,8 250



Grater, non-slip handle

Grattugia, manico antiscivolo
Reibe, Rutschfestes Griff
Râpe queue antidérapant
Rallador mango antiderrapante

art.

cm.

l. cm.

42560-01 4x22 38,5



Grater, non-slip handle

Grattugia, manico antiscivolo
Reibe, Rutschfestes Griff
Râpe queue antidérapant
Rallador mango antiderrapante

art.

cm.

l. cm.

42560-02 4x22 38,5



Grater, non-slip handle

Grattugia, manico antiscivolo
Reibe, Rutschfestes Griff
Râpe queue antidérapant
Rallador mango antiderrapante

art.

cm.

l. cm.

42560-03 4x22 38,5



Grater, non-slip handle
 Grattugia, manico antiscivolo
 Reibe, Rutschfestes Griff
 Râpe queue antidérapant
 Rallador mango antiderrapante

art. cm. l. cm.

42560-04 7,7x13,3 30



Grater, non-slip handle
 Grattugia, manico antiscivolo
 Reibe, Rutschfestes Griff
 Râpe queue antidérapant
 Rallador mango antiderrapante

art. cm. l. cm.

42560-05 7,7x13,3 30



Grater, non-slip handle
 Grattugia, manico antiscivolo
 Reibe, Rutschfestes Griff
 Râpe queue antidérapant
 Rallador mango antiderrapante

art. cm. l. cm.

42560-06 7,7x13,3 30



Grater, non-slip handle
 Grattugia, manico antiscivolo
 Reibe, Rutschfestes Griff
 Râpe queue antidérapant
 Rallador mango antiderrapante

art. cm. l. cm.

42560-07 7,7x13,3 30



Grater, non-slip handle
 Grattugia, manico antiscivolo
 Reibe, Rutschfestes Griff
 Râpe queue antidérapant
 Rallador mango antiderrapante

art. cm. l. cm.

42560-08 7,7x13,3 30



Grater, non-slip handle
 Grattugia, manico antiscivolo
 Reibe, Rutschfestes Griff
 Râpe queue antidérapant
 Rallador mango antiderrapante

art. cm. l. cm.

42560-09 7,7x13,3 30



Spätzle sieve
 Grattugia per spätzle
 Spätzle-Reibe
 Grille à spätzle
 Rallador para spätzle

art. cm.

49844-01 31x10,5x6



Nutmeg grater
 Grattugia noce moscata
 Muskatreibe
 Râpe à muscade
 Rallador nuez moscada

art. cm.

42556-00 4,5x14



4-ways grater
 Grattugia 4 tagli
 Vierkantreibe
 Râpe 4 faces
 Rallador 4 caras

art. cm.

42569-04 10x8x23



PP

Dumplin maker

Stampo panzerotti
Knödel-Form
Moule à chaussons
Molde para empanadillas

art.	mm.
49843-05	62, 82, 104, 177



Safety can opener

Apriscatole sicuro
Sicherheitsdosenöffner
Ouvre-boîte de sûreté
Abrelatas de seguridad

art.	cm.
48222-01	12,5x8



Universal can opener

Apriscatole universale, nichelato
Universal-Dosenöffner
Ouvre-boîte, universel
Abrelatas universal

art.	cm.
48220-00	8x7



Can opener, PP handle

Apriscatole, impugnatura PP
Dosenöffner, Griffe aus PP
Ouvre-boîte, poignées PP
Abrelatas, mango PP

art.	l. cm.
48280-03	21



SS

Electric sieve

Passaverdura elettrico
Elektropassiergerät
Moulin électrique
Molino eléctrico

art.	Ø cm.	h.	kg./H	Kg.
49879-37	37	108	300	23,5

Equipped with 3 mm disc. – Griglia 3 mm.



Sieve on tripod, tinned

Passaverdura stagnato con supporto
Passiergerät, verzinkt, mit Träger
Moulin étamé sur pied
Molino estañado sobre pie

art.	Ø cm.	h.	Kg.
42577-39	39	80	14

Equipped with 3 mm disc. – Griglia 3 mm.



Tomato juicer sieve

Passapomodori, professionale
Profi-Tomatenpassiergerät
Moulin à tomates professionnel
Molino para tomates, profesional

art.	Ø cm.	h.
42576-00	21	50

Equipped with 1 mm disc. – Griglia 1 mm.



SS

Herb mill

Macinaerbe
Kräutermühle
Moulin fines herbes
Molino de hierbas finas

art.	cm.
42558-00	7x22



SS

Sieve, 3 discs

Passaverdura, 3 griglie
 Passiergerät, 3 Roste
 Moulin inox, 3 grilles
 Molino inox, 3 rejillas

art.	Ø cm.	h.	Kg.
42571-20	19	16,5	0,46
42572-24	24	16,5	0,82

Discs: 1,5 - 2 - 4 mm. – Griglie: 1,5 - 2 - 4 mm.



SS

Sieve, 3 discs

Passaverdura, 3 griglie
 Passiergerät, 3 Roste
 Moulin inox, 3 grilles
 Molino inox, 3 rejillas

art.	Ø cm.	h.	Kg.
42570-32	31	25	1,4

Discs: 1,5 - 2,5 - 4 mm. – Griglie: 1,5 - 2,5 - 4 mm.



Sieve, tinned, 3 discs

Passaverdura stagnato, 3 griglie
 Passiergerät, verzinkt, 3 Roste
 Moulin étamé, 3 grilles
 Molino estañado, 3 rejillas

art.	Ø cm.	h.	Kg.
42573-31	31	25	1,4

Discs: 1,5 - 2,5 - 4 mm. – Griglie: 1,5 - 2,5 - 4 mm.



SS

Sieve, 1 disc

Passaverdura, 1 griglia
 Passiergerät, 1 Rost
 Moulin inox, 1 grille
 Molino inox, 1 rejilla

art.	Ø cm.	h.	Kg.
42574-37	37	32	3,5

Equipped with 3 mm disc. – Griglia 3 mm.



Sieve, tinned, 1 disc

Passaverdura stagnato, 1 griglia
 Passiergerät, verzinkt, 1 Rost
 Moulin étamé, 1 grille
 Molino estañado, 1 rejilla

art.	Ø cm.	h.	Kg.
42575-37	37	32	3,5

Equipped with 3 mm disc. – Griglia 3 mm.



42570 - 42573



42574 - 42575

42577 - 49879





Table top can opener

Apriscatole da banco
Tisch-Dosenöffner
Ouvre-boîte
Abrelatas

art.	cm.	Kg.
49813-00	25x25x57	3,1

Can size up to ø 330mm, height from 40 to 320 mm. – Formati scatola fino a ø 330 mm, h da 40 a 320 mm.



Table top can opener

Apriscatole da banco
Tisch-Dosenöffner
Ouvre-boîte
Abrelatas

art.	l. cm.
19810-00	56

Can size up to height 45 cm. Clamp base and bar in die-cast aluminum, steel head. Table fixing either with screws or clamp. – Altezza scatola fino a 45 cm. Corpo in alluminio pressofuso, testa in acciaio, fissaggio a viti o morsetto.



Table top can opener, steel

Apriscatole da banco, acciaio
Tisch-Dosenöffner, Stahl
Ouvre-boîte, acier
Abrelatas, acero

art.	l. cm.
49811-00	40

Can size up to height 30 cm. Table fixing with clamp base. – Altezza scatola fino a 30 cm. Fissaggio a morsetto.



Table top can opener

Apriscatole da banco
Tisch-Dosenöffner
Ouvre-boîte
Abrelatas

art.	l. cm.
49812-00	55

Can size up to height 40 cm. Table fixing with clamp base. – Altezza scatola fino a 40 cm. Fissaggio a morsetto.



Table top can opener

Apriscatole da banco
Tisch-Dosenöffner
Ouvre-boîte
Abrelatas

art.	l. cm.
49861-00	56

Can size up to height 40 cm. Clamp base and bar in stainless steel, cast iron head. Table fixing with clamp. – Altezza scatola fino a 40 cm. Corpo e asta in acciaio inox, testa in acciaio, fissaggio con morsetto.



Table top can opener

Apriscatole da banco
Tisch-Dosenöffner
Ouvre-boîte
Abrelatas

art.	l. cm.
49861-10	55

Clamp model. For uses up to 15-20 cans per day, max height 43 cm. – Con morsetto. Ideale per 15-20 lattine al giorno di h. 43 cm max.



Electric can opener

Apriscatole elettrico
Elektrodosenöffner
Ouvre-boîte électrique
Abrelatas eléctrico

art.	cm.	Kg.
49814-00	44x25x75	13

Dual speed motor. Opens all can shapes from 50 to 270 mm height. – Motore a 2 velocità. Per tutti i formati di scatola da 50 a 270 mm di altezza.



Electric can opener

Apriscatole elettrico
Elektrodosenöffner
Ouvre-boîte électrique
Abrelatas eléctrico

art.	cm.	Kg.
49862-00	11x16x28	6,5

Dual speed heavy motor. Cans max height 17 cm. – Motore a 2 velocità. Altezza max scatole 17 cm.



Cleaning brush

Spazzola di pulizia
Reinigungsbürste
Brosse de nettoyage
Cepillo para limpieza

art.
49861-01

THERMOMETERS TERMOMETRI

KITCHEN UTENSILS
UTENSILI DA CUCINA





SS

Meat roasting thermometer
Termometro arrostiti
Braten-Thermometer
Thermomètre à rôtir
Termómetro asado

art. Ø cm. scala range
49705-00 4,5 1°C 0+120°C

Penetration probe 13 cm. – Sonda l. 13 cm.



SS

Meat roasting thermometer
Termometro arrostiti
Braten-Thermometer
Thermomètre à rôtir
Termómetro asado

art. Ø cm. range
19705-00 5 +54+88°C



SS

Cooking & frying thermometer
Termometro fritti
Back-Thermometer
Thermomètre à friture
Termómetro frituras

art. Ø cm. scala range
19706-00 5 10°C +38+205°C



Sugar thermometer
Termometro per zucchero
Zuckerthermometer
Thermomètre à sucre
Termómetro azúcar

art. l. cm. scala range
47843-00 30 1°C +80+200°C

Stainless steel housing. – Guaina inox.



Baker's thermometer
Termometro per panettiere
Bäckerthermometer
Thermomètre boulanger
Termómetro panadero

art. l. cm. scala range
49712-00 30 1°C -10+60°C

Plastic housing. – Guaina plastica.



SS

Oven thermometer
Termometro per forno
Ofenthermometer
Thermomètre à four
Termómetro horno

art. Ø cm. scala range
19709-00 7 10°C +38+316°C



ABS

Fridge/freezer thermometer
Termometro frigo/freezer
Kühlschrankthermometer
Thermomètre à réfrigérateur
Termómetro congelador

art. Ø cm. scala range
49885-02 7 1°C -50+50°C



SS

Fridge/freezer thermometer
Termometro frigo/freezer
Kühlschrankthermometer
Thermomètre à réfrigérateur
Termómetro congelador

art. Ø cm. scala range
19702-00 6 1°C -29+27°C



ABS

Digital thermometer
Termometro digitale
Digitalthermometer
Thermomètre digitale
Termómetro digital

art. scala range
49887-00 0,1°C -50+70°C

Dim. cm. 1,5x5x7



Room/wall thermometer
Termometro da muro
Wandthermometer
Thermomètre à mur
Termómetro de pared

art. scala range
49702-00 1°C -30+50°C

Dim. cm. 20,5x4. Without mercury.
Senza mercurio.



Pocket thermometer
Termometro da tasca
Taschenthermometer
Thermomètre à poche
Termómetro digital

art. l. cm. scala range
19701-00 15 0,1°C -50+150°C



Digital thermometer
Termometro digitale
Digitalthermometer
Thermomètre digitale
Termómetro digital

art. scala range
49710-00 1°C -50+300°C

Probe 135 mm. ø 2,5 mm.
Sonda 135 mm. ø 2,5 mm.



Pocket thermometer

Termometro da tasca
Taschenthermometer
Thermomètre à poche
Termómetro digital

art. scala range
49701-00 0,1°C -50+200°C

Probe 125 mm. ø 3,5 mm.
Sonda 125 mm. ø 3,5 mm.



Digital thermometer

Termometro digitale
Elektronisches Thermometer
Thermomètre digital
Termómetro digital

art. scala range
49715-00 0,1°C -50+300°C

Probe 125 mm. ø 3,5 mm.
Sonda 125 mm. ø 3,5 mm.



Digital thermometer

Termometro digitale
Elektronisches Thermometer
Thermomètre digital
Termómetro digital

art. scala range
49716-00 0,1°C -50+300°C

Dim. cm. 1,9x7x15,2. Countdown/up 99h-59m.



Digital thermometer

Termometro digitale
Elektronisches Thermometer
Thermomètre digital
Termómetro digital

art. scala range
49883-00 0,1°C -50+300°C

Dim. cm. 13x5,5x2,5. ABS case contains "Biomaster", additive. Probe 13 cm.
Involucro ABS con "Biomaster". Sonda 13 cm.



Multi-function thermometer

Termometro multifunzione
Multifunktions-Thermometer
Thermomètre multifonction
Termómetro multifunción

art. scala range
49988-00 0,1°C -49,9+149,9°C

Dim. cm. 3,2x8,6x11,6. Probe 125 mm. ø 3,5 mm.
Sonda 125 mm. ø 3,5 mm.



Infrared thermometer

Termometro a infrarossi
Infrarot-Thermometer
Thermomètre infrarouge
Termómetro infrarrojo

art. scala range
49986-00 0,1°C -49,9+349,9°C

Dim. cm. 2,5x5,2x10



Infrared thermometer

Termometro a infrarossi
Infrarot-Thermometer
Thermomètre infrarouge
Termómetro infrarrojo

art. scala
49884-08 0,1/1°C

Dim. cm. 4x6,6x15,5. Range infrared-Infrarossi: -60 to 500°C – Range probe-Sonda: -64 to 1370°C.



Infrared thermometer

Termometro a infrarossi
Infrarot-Thermometer
Thermomètre infrarouge
Termómetro infrarrojo

art. scala range
49717-00 1°C -50+400°C

Dim. cm. 17,5x4x7,2



Infrared thermometer

Termometro a infrarossi
Infrarot-Thermometer
Thermomètre infrarouge
Termómetro infrarrojo

art. scala range
49987-00 0,1°C -50+330°C

Dim. cm. 3,6x8,8x13,1



Digital thermometer
Termometro digitale
Elektronisches Thermometer
Thermomètre digital
Termómetro digital

art.	scala	range	col.
49880-10	0,1/1°C	-49,9+299,9°C	●
49880-11	0,1/1°C	-49,9+299,9°C	●
49880-12	0,1/1°C	-49,9+299,9°C	●

Dim. cm. 1,9x5x15,7. S/s probe Ø 3,3 x 115 mm. folds back through 180°.



Digital thermometer
Termometro digitale
Elektronisches Thermometer
Thermomètre digital
Termómetro digital

art.	scala	range	col.
49880-13	0,1/1°C	-49,9+299,9°C	●
49880-14	0,1/1°C	-49,9+299,9°C	●
49880-15	0,1/1°C	-49,9+299,9°C	○

Sonda inox Ø 3,3 x 115 mm. pieghevole a 180°.



Spatula with thermometer
Spatola con termometro
Rührspaten mit Thermometer
Spatule avec thermomètre
Espátula con termómetro

art.	range
49729-00	-50+300°C

Dim. cm. 26x4x1,8



Sous vide cooking thermometer
Termometro per sottovuoto
Vakuüm-Koch-Thermometer
Thermomètre pour cuisson sous-vide
Termómetro cocción al vacío

art.	scala	range
49881-01	0,1°C	-99,9+299,9°C 1°C +300+1372°C

Kit: thermometer, Sous-Vide needle probe 60 mm., one metre foam/tape, zip pouch, free traceable certificate of calibration.

Kit: termometro, sonda per sottovuoto 60 mm., 1 metro di nastro adesivo, astuccio con zip, certificato di calibrazione tracciabile.



Digital oven thermometer
Termometro digitale da forno
Ofen-Digitalthermometer
Thermomètre à four digital
Termómetro horno digital

art.	Ø cm.	scala	range
49719-00	8	1°C/F	-50+300°C

Loud 70dB audible temperature alarm. 114 mm probe with 1,2 metre s/s braided lead that allows the probe to remain in the food during cooking. Water/dust resistance: IP65 protection.
Allarme acustico 70dB. Sonda 114 mm., cavo inox 1,2 metri che permette l'utilizzo durante la cottura. Resistenza acqua/polvere. IP65.



Oven timer, cooking thermometer
Timer, termometro da forno
Digitalkochalarm
Minuterie digitale
Reloj, termómetro digital

art.	scala	range
49718-00	1°C	0+300°C

Dim. cm. 13x7,5x2. Count down/up from/to 23h 59m 59sec. High temperature probe cm 15 Ø 4 mm. S/s braided lead 2 metres.

Timer 23h 59min 59sec. Sonda ad alta temperatura 15 cm Ø 4 mm. Cavo 2 metri.



Waterproof digital timer

Timer digitale a tenuta stagna
Wasserdichte Digitaltimer
Timer digital étanche
Reloj digital impermeable

art. Ø cm. h.
49733-00 8 17

99M-99S. Dust and flour proof. Sound and flashing alarms. Hanging hook and suction cup.

A prova di polvere e farina. Suono e allarme lampeggiante. Gancio e ventosa.



Digital timer

Timer digitale
Digitalkochalarm
Minuterie digitale
Reloj digital

art. cm.
49720-00 7x5,5

Timer 23H-59M-59S. Clock 12H AM/PM. Count down. 80dB audible alarm. Magnetic pad.

Orologio 12H AM/PM. Cronometro. Allarme acustico 80dB. Attacco magnetico.



Digital timer

Timer digitale
Digitalkochalarm
Minuterie digitale
Reloj digital

art. cm.
49734-00 9x4,7x4,5

Count-down/up: 23H 59M 59S



Digital timer jumbo

Timer digitale gigante
Digitalkochalarm jumbo
Minuterie digitale géante
Reloj digital gigante

art. cm.
49735-00 13,5x9,5x16



Syrup density meter

Pesa sciroppo, densimetro
Sirup-Hydrometer
Pèse-sirop
Aerómetro

art. l. cm.
49703-00 12,5

g/ml/°Bé: 1.100-1.400/15-40 - °C20
Div.: 0,010 g/ml/2°Bé.



Hydrometer for brine and salt

Densimetro per salamoia e sale
Hydrometer für Sole und Salz
Densimètre pour saumure et sel
Hidrómetro salmuera y sal

art. l. cm.
49730-20 19,5

g/ml/°Bé: 1.000-1.250/0-30 - °C20
Div.: 0,001 g/ml/2°Bé.



Salt manager and thermometer

Salinometro e termometro
Salzgehalt-Meter u. Thermometer
Testeur de salinite et thermometer
Salinometro y termómetro

art. cm.
49730-00 3,2x1,6x22,5



NEW

Cooking oils tester

Test degradazione oli di frittura
Kontrollsystem für Bratenöle
Test des huiles
Controlador de aceite de frituras

art.
49731-10

Consisting of two reagents that are not harmful to health and environmentally friendly. For 20 tests. ATTENTION: works with all types and brands of frying oil, (except with palm oil).

Composto da due reagenti non nocivi per la salute e rispettosi dell'ambiente. Per 20 test. ATTENZIONE: funziona con tutti i tipi e le marche di olio di frittura, (tranne che con l'olio di palma).



- NEW OIL <9% of polar compounds**
OLIO NUOVO <9% di composti polari
- GOOD OIL from 10 to 16% of polar compounds**
OLIO BUONO da 10 a 16% di composti polari
- DETERIORATED OIL from 17 to 23% of polar compounds**
OLIO DETERIORATO da 17 a 23% di composti polari
- OIL TO CHANGE >24% of polar compounds**
OLIO DA CAMBIARE >24% di composti polari



NEW

Solvable labels 6 rolls x250 pcs
Etichette dissolvibili 6 rotoli x250 pz
Lösbare Etiketten 6 Rollen X250 Stück
Etiquettes solubles 6 rouleaux x250 pcs
Etiquetas solubles 6 rollos x250 pcs

art. cm. pcs/pz
44630-01 7,5x4 1500

Dissolvable in less than 20 seconds. Suitable for any type of surface. – Dissolvibili in meno di 20 secondi. Adatte a qualsiasi tipo di superficie.



NEW

Labels 14 allergens 6 rolls x500 pcs
Etichette 14 allergeni 6 rotoli x500 pz
Etiketten 14 Allergene 6 Rollen X500 Stück
Etiquettes 14 allergènes 6 rouleaux x500 pcs
Etiquetas 14 alergenos 6 rollos x500 pcs

art. cm. pcs/pz
44630-02 7,5x4 3000

Labels with all 14 allergens pre-printed.
Etichette con tutti i 14 allergeni pre-stampati.



NEW

Express labels 7 days x250 pcs
Etichette express 7giorni x250 pz
Etiketten Express 7 Tage X250 Stück
Etiquettes express 7 jours x250 pcs
Etiquetas 7 días x250 pcs

art. cm. pcs/pz
44630-03 3x2,5 1750

Different colors based on the day of the week. Data to be written: product description; date of production or expiry date.
Diversi colori in base al giorno della settimana. Dati da inserire: descrizione del prodotto; data di produzione o data di scadenza



Wall clock ORION
Orologio da parete
Wanduhr
Horloge à paroi
Reloj de pared

art. Ø cm.
41380-01 29

Satin alloy. – Metallo satinato.



ABS



Wall clock SILENT
Orologio da parete
Wanduhr
Horloge à paroi
Reloj de pared

art. Ø cm.
41380-02 30,5

Silent clock. – Movimento silenzioso.



ABS

SS

Digital scale
Bilancia digitale
Präzisionswaage
Balance digitale
Balanza digital

art. cm. Kg. scala
49865-06 21,6x17,1x6,3 6 1g

Antimicrobial protection. Portion count. Removable platform cm 14,6x16,5. AC adapter/ batteries supply. – Protezione antimicrobica. Conteggio porzioni. Piattaforma cm 4,6x16,5. Adattatore AC/batterie.



Digital scale
Bilancia digitale
Präzisionswaage
Balance digitale
Balanza digital

art. cm. Kg. scala
49865-70 30,5x31,8x5,7 68 100g

Platform cm 30,5x30,5. Remote LCD wall mount display. Electric or batteries supply.
Piattaforma cm 30,5x30,5. Schermo LCD rimovibile per montaggio a parete. Alimentazione corrente/ batteria.





SS

Mechanical scale
Bilancia meccanica
Waage
Balance
Balanza

art.	Ø cm.	Kg.	scala
49864-03	20	3	10g
49864-05	20	5	20g



SS

Mechanical scale
Bilancia meccanica
Waage
Balance
Balanza

art.	Ø cm.	Kg.	scala
49864-20	25	20	100g



SS

Digital kitchen scale
Bilancia digitale da cucina
Digital-Küchenwaage
Balance de cuisine
Balanza digital de cocina

art.	cm.	Kg.	scala
49773-05	21,5x13	5	1g



Pocket scale
Bilancia tascabile
Taschenwaage
Balance de poche
Balanza de bolsillo

art.	cm.	Kg.	scala
49771-00	15x10x2,5	0,25	0,1 g



ABS

SS

Digital scale
Bilancia digitale
Digitalwaage
Balance digitale
Balanza digital

art.	cm.	Kg.	scala
49775-05	24,5x31x9,5	5	1g
49775-10	24,5x31x9,5	10	1g



ABS

SS

Digital scale
Bilancia digitale
Digitalwaage
Balance digitale
Balanza digital

art.	cm.	Kg.	scala
49777-50	29x33,5x11	50	1g

Unit: Kg/lb.

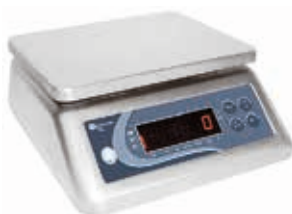

SS

Digital scale
Bilancia digitale
Digitalwaage
Balance digitale
Balanza digital

art.	cm.	Kg.	scala
49776-15	24x29x11	15	1g
49776-30	24x29x11	30	2g



ABS

SS

Digital scale with platform
Bilancia digitale con piattaforma
Digitalwaage mit Plattform
Balance digitale avec plate-forme
Balanza digital con plataforma

art.	cm.	Kg.	scala
49779-15	50x40x84	150	20g
49779-30	60x50x84	300	50g

SERIES 18100

FORGED KNIVES
COLTELLI FORGIATI



A deep study and computerised tests of ergonomics, movement and posture have allowed Paderno to create a professional knives line, that is the synthesis of comfort and cutting precision. Handle made of plastic specially developed for the food processing sector, ergonomic design with soft edges, perfect grip to ensure precise guidance. The forged blade realised in special steel and molybdenum/vanadium, thanks to a peculiar hardening process, guarantees to the product a perfect cut and a long life of the blade's edge.

Uno studio approfondito e prove computerizzate di ergonomia, movimento e postura hanno permesso a Paderno di creare una linea di coltelli professionali, sintesi perfetta tra comfort e perfezione del taglio. Manico realizzato in speciale materiale plastico sviluppato per il settore alimentare, design ergonomico con bordi arrotondati, presa perfetta per garantire un taglio di precisione. Lama forgiata realizzata in lega di speciale acciaio, molibdeno e vanadio con particolare processo di tempra che garantisce al prodotto un ottimo taglio ed una perfetta e lunga tenuta di filo.



Cook's knife

Coltello cucina
Kochmesser
Couteau cuisine
Cuchillo de cocinero

art.	cm.
18100-16	16
18100-20	20
18100-24	24
18100-30	30
18100-36	36



Butcher's knife

Coltello francese
Kochmesser
Couteau de chef
Cuchillo de carnicero

art.	cm.
18102-16	16
18102-20	20
18102-26	26
18102-30	30



Oriental cook's knife

Coltello cucina orientale
Japanisches Kochmesser
Couteau de chef style japonais
Cuchillo cocinero japoné

art.	cm.
18103-18	18



Oriental cook's knife, dimpled ground

Coltello cucina orientale, alveolato
Japanisches Kochmesser mit Kullenschliff
Couteau de chef style japonais alveolé
Cuchillo cocinero japonés, con alvéolos

art.	cm.
18104-18	18



Slicer

Coltello affettare
Fleischmesser
Tranchelard
Cuchillo para filetear

art.	cm.
18106-15	15
18106-20	20
18106-25	25
18106-30	30



Ham knife

Coltello prosciutto
Schinkenmesser
Trancheur à rôti
Cuchillo para jamón

art.	cm.
18109-26	26
18109-30	30
18109-36	36



Ham knife, dimpled ground

Coltello prosciutto, alveolato
Schinkenmesser mit Kullenschliff
Couteau à rôti alvéolé
Cuchillo para jamón, con alvéolos

art.	cm.
18110-26	26
18110-30	30
18110-36	36



Salmon knife

Coltello salmone
Lachsmesser
Couteau à saumon
Cuchillo para salmón

art.	cm.
18111-30	30



Salmon knife, dimpled ground

Coltello salmone, alveolato
Lachsmesser mit Kullenschliff
Couteau à saumon alvéolé
Cuchillo para salmón, con alvéolos

art.	cm.
18112-30	30



Carving knife

Coltello trinciante
Filiermesser
Couteau à découper
Cuchillo para trinchar

art.	cm.
18114-20	20



Filleting, flexible

Coltello filettare, flessibile
Filiermesser, flexibel
Filet de sole, flexible
Cuchillo para filetear, flexible

art.	cm.
18115-20	20
18115-25	25



Boning knife

Coltello disosso
Ausbeinmesser
Couteau à désosser
Cuchillo para deshuesar

art.	cm.
18116-14	14
18116-18	18



Steak knife

Coltello bistecca
Steakmesser
Couteau à steak
Cuchillo para steak

art.	cm.
18122-12	12



Paring knife

Spelucchino
Spickmesser
Couteau d'office
Cuchillo mondador

art.	cm.
18124-09	9



Paring knife

Spelucchino
Spickmesser
Couteau d'office
Cuchillo mondador

art.	cm.
18125-07	7
18125-10	10



Bent paring knife

Coltello cuoco
Tourniermesser
Bec d'oiseau
Cuchillo verdura

art.	cm.
18126-07	7



Table knife

Coltello tavola
Allzweckmesser
Couteau bout rond cranté
Cuchillo para mesa

art.	cm.
18123-11	11



Bread knife

Coltello pane
Brotmesser mit Wellenschliff
Couteau à pain ondulé
Cuchillo para pan

art.	cm.
18128-20	20
18128-24	24
18128-30	30



Meat fork

Forchettone
Fleischgabel
Fourchette diapason
Tenedor para carne

art.	cm.
18230-13	13
18230-17	17



Carving fork curved

Forchettone curvo
Fleischgabel
Fourchette à viande
Tenedor curvo para carne

art.	cm.
18231-13	13

SERIES 18000

STAMPED KNIVES
COLTELLI TRANCIATI



The professional cutlery line “Color-Line” helps to reduce the risk of cross contamination using a Color Coding System which identifies each knife with a specific task: different food processing areas are easily identified. The steel used for this cutlery line has exceptional hardness and very high resistance to corrosion due to ICE-HARDENED system, a special process to harden the steel. The colors of the handle for each article are indicated, as well as the dimensions of the respective blades. The reference in the descriptions (ex. 18000-16) refers to the handle in black color. The code of the colored handle is given by replacing the hyphen with the corresponding letter of the color, please see the key. For instance if you would like to order a knife with the red handle, the corresponding letter is “R” and the reference is 18000R16.

La linea di coltelleria professionale “CCS”– Color Coding System riduce i rischi di contaminazione incrociata grazie all'utilizzo di un Sistema di Codifica dei Colori che identifica ogni coltello per un uso specifico e permette di individuare facilmente le diverse aree di lavoro. Gli acciai utilizzati per questa linea di coltelleria presentano un'eccezionale durezza ed elevata resistenza alla corrosione, grazie all'uso del sistema ICE-HARDENING, processo speciale per temperare l'acciaio. Per ogni articolo sono riportati i colori del manico in cui si rende disponibile, nonché le dimensioni delle rispettive lame. Il codice indicato nelle tabelle (es. 18000-16) si riferisce al manico in colore nero. Il codice del manico colorato si ottiene sostituendo il trattino con la lettera corrispondente al colore, da ricercarsi nella legenda. Se ad esempio si vuole ordinare un coltello con il manico rosso, la lettera corrispondente è la “R” e il codice di riferimento il 18000R16.



R = ROSSO / RED
Carni crude
Raw meat

M = MARRONE / BROWN
Verdure
Vegetables

B = BLU / BLUE
Pesce
Raw fish

Y = GIALLO / YELLOW
Carni cotte, polleria
Cooked meat, poultry

G = VERDE / GREEN
Insalate, frutta
Salad, fruit

W = BIANCO / WHITE
Latticini, pane
Dairy products, bakery



Cook's knife

Coltello cucina
Kochmesser
Couteau cuisine
Cuchillo de cocinero

art.	cm.	col.
18000-16	16	●●●●●●●●
18000-20	20	●●●●●●●●
18000-23	23	●●●●●●●●
18000-26	26	●●●●●●●●
18000-30	30	●●●●●●●●
18000-36	36	●●●●●●●●



Butcher's knife

Coltello scimitarra
Blockmesser
Couteau à découper
Cuchillo de carnicero

art.	cm.	col.
18005-22	22	●●●●●●●●
18005-27	27	●●●●●●●●
18005-32	32	●●●●●●●●



Butcher's knife

Coltello francese
Schlachtmesser
Couteau à découper
Cuchillo carnicero francés

art.	cm.	col.
18002-18	18	●●●●●●●●
18002-20	20	●●●●●●●●
18002-22	22	●●●●●●●●
18002-26	26	●●●●●●●●
18002-30	30	●●●●●●●●
18002-36	36	●●●●●●●●



Slicer knife

Coltello affettare
Wurstmesser
Couteau à jambon
Cuchillo para filetear

art.	cm.	col.
18006-20	20	●●●●●●●●
18006-25	25	●●●●●●●●
18006-30	30	●●●●●●●●
18006-36	36	●●●●●●●●



Slicer knife, wavy blade

Coltello affettare, dentato
Wurstmesser mit Wellenschliff
Couteau à jambon ondulé
Cuchillo para filetear, dentado

art.	cm.	col.
18007-25	25	●●●●●●●●
18007-30	30	●●●●●●●●
18007-36	36	●●●●●●●●



Cook's knife

Coltello cucina
Kochmesser
Couteau cuisine
Cuchillo cocina

art.	cm.	col.
18008-20	20	●●●●●●●●
18008-26	26	●●●●●●●●
18008-30	30	●●●●●●●●
18008-36	36	●●●●●●●●



Ham knife

Coltello prosciutto
Schinkenmesser
Trancheur à rôti
Cuchillo para jamón

art.	cm.	col.
18009-25	25	●●●●●●●●
18009-30	30	●●●●●●●●
18009-36	36	●●●●●●●●



Salmon knife

Coltello salmone
Lachsmesser
Couteau à saumon
Cuchillo salmón

art.	cm.	col.
18011-32	32	●●●●●●●●



Ham knife, dimpled ground

Coltello prosciutto, alveolato
Schinkenmesser mit Kullenschliff
Couteau à rôti alvéolé
Cuchillo jamón con alvéolos

art.	cm.	col.
18010-25	25	●
18010-30	30	●●
18010-36	36	●



Salmon knife, dimpled ground

Coltello salmone, alveolato
Lachsmesser mit Kullenschliff
Couteau à saumon alvéolé
Cuchillo salmón con alvéolos

art.	cm.	col.
18012-32	32	●●



Cheese slicer

Coltello salati/Formaggio
Universalmesser
Couteau universel
Cuchillo universal/quesos

art.	cm.	col.
18013-30	30	●○
18013-36	36	●○



Filetting knife

Coltello per filettare
Filiermesser
Filet de sole
Cuchillo para filetear

art.	cm.	col.
18015-18	18	●●●●
18015-22	22	●●●●
18015-27	27	●●



Boning knife

Coltello disosso
Ausbeinmesser
Couteau à désosser
Cuchillo para deshuesar

art.	cm.	col.
18016-14	14	●●●●
18016-16	16	●○●●●●



Boning knife

Coltello disosso emilia
Ausbeinmesser
Couteau à désosser
Cuchillo para deshuesar

art.	cm.	col.
18017-14	14	●
18017-16	16	●●●●
18017-18	18	●



Poultry sticking knife

Coltello scannapolli
Geflügelschlachtmesser
Couteau à volaille
Cuchillo para deshuesar

art.	cm.	col.
18018-11	11	●●●



Sticking knife

Coltello scannare
Stechmesser
Couteau à saigner
Cuchillo para destrozar

art.	cm.	col.
18019-12	12	●●●
18019-14	14	●
18019-16	16	●●●
18019-18	18	●●●
18019-20	20	●●●



Frozen food, two serrated edges

Coltello surgelati a doppia lama seghettata
Tiefkühltruhenmesser, Gezahnter Schliff
Couteau dentelé pour produits surgelés
Cuchillo para congelados, hoja doble, dentada

art.	cm.	col.
18020-23	23	●●●



Frozen food special serrated blade

Coltello surgelati lama seghettata speciale
Tiefkühltruhenmesser, Gezahnter Schliff
Couteau dentelé pour produits surgelés
Cuchillo para congelados, dentado especial

art.	cm.	col.
18021-18	18	●●●●



Steak knife

Coltello bistecca
Steakmesser
Couteau à steak
Cuchillo para steak

art.	cm.	col.
18022-12	12	●



Table knife, half-waved

Coltello tavola, mezzo dentato
Allzweckmesser
Couteau universel
Cuchillo mesa, medio dentado

art.	cm.	col.
18023-11	11	●



Steak knife

Coltello bistecca
Steakmesser
Couteau à steak
Cuchillo para steak

art.	cm.	U. Pack
18217-12	12	6



Paring knife

Spelucchino
Spickmesser
Couteau d'office
Cuchillo mondador

art.	cm.	col.
18024-08	8	● ○ ● ● ● ● ● ●
18024-11	11	● ○ ● ● ● ● ● ●



Bent paring knife

Spelucchino
Tourniermesser
Bec d'oiseau
Cuchillo verdura

art.	cm.	col.
18026-07	7	● ● ● ● ● ●



Baker's knife

Coltello pasticceria
Bäckermesser
Couteau de pâtissier
Cuchillo para pastelería

art.	cm.	col.
18029-30	30	● ○
18029-36	36	● ○



Bread knife

Coltello pane
Brotmesser
Couteau à pain
Cuchillo para pan

art.	cm.	col.
18028-21	21	● ○



Bread knife

Coltello pane
Brotmesser
Couteau à pain
Cuchillo para pan

art.	cm.	col.
18028-25	25	● ○ ● ● ● ● ● ●
18028-30	30	● ○ ● ● ● ● ● ●
18028-36	36	● ○



Universal knife, wavy edge

Coltello universale, seghettato
Universalmesser mit Wellenschliff
Couteau universel, lame dentelée
Cuchillo universal serrado

art.	cm.	col.
18029-25	25	● ○



Cake knife

Coltello dolce
Bäckermesser
Couteau de pâtissier
Cuchillo para pastelería

art.	cm.	col.
18030-26	26	● ○
18030-31	31	● ○
18030-36	36	● ○





Slicer, chinese style

Falcetta cinese
Kochmesser, chinesische Form
Couteau de cuisine, style chinois
Cuchillo cocina, estilo chino

art.	cm.	col.
18221-17	17	● ● ● ● ● ●
18221-19	19	● ● ● ● ● ●
18221-21	21	● ● ● ● ● ●



Meat cleaver

Falcetta macellaio
Hackmesser
Couperet
Hacha de carnicero

art.	cm.	Kg.	col.
18220-18	18	0,55	● ● ● ● ● ●
18220-20	20	1,10	● ● ● ● ● ●
18220-22	22	1,30	● ● ● ● ● ●



Meat cleaver

Falcetta macellaio
Hackmesser
Couperet
Hacha de carnicero

art.	cm.	Kg.	col.
18220-26	26	1,3	● ● ● ● ● ●



Bone splitter

Mezzo colpo
Kochschlagmesser
Couteau de cuisine lourd
Cuchillo cocina pesado

art.	cm.	Kg.	col.
18224-28	28	0,75	● ● ● ● ● ●



Bone splitter

Colpo
Kochschlagmesser
Couteau de cuisine lourd
Cuchillo cocina pesado

art.	cm.	Kg.	col.
18225-28	28	1	● ● ● ● ● ●



Parmesan knife

Grana
Parmesanmesser
Couteau à Parmesan
Cuchillo para queso

art.	cm.
18205-10	10



Parmesan knife

Grana
Parmesanmesser
Couteau à Parmesan
Cuchillo para queso

art.	cm.
18205-12	12



Cheese knife

Coltello segnaforme
Käsemesser
Couteau à fromage
Cuchillo para queso

art.	cm.
18206-09	9



Cheese knife

Coltello lancia "Milano"
Käsemesser
Couteau à fromage
Cuchillo para queso

art.	cm.
18207-15	15



Oyster knife

Coltello apriostriche
Austernmesser
Couteau à huîtres
Cuchillo ostras

art.	cm.
18209-06	15



Cheese knife
Coltello formaggio
Käsemesser
Couteau à fromage
Cuchillo queso

art. cm.
18201-36 36



Vegetables knife
Coltello verdure
Gemüsemesser
Couteau à crudités
Cuchillo verduras

art. cm.
18222-18 18



Ham boner
Cannula disosso prosciutti
Schinkenauslöser
Gouge à jambons
Cuchillo deshuesar jamón

art. cm.
48021-21 21



Cheese knife
Coltello formaggio
Käsemesser
Couteau à fromage
Cuchillo para queso

art. cm.
18203-26 26



Baking pan knife
Coltello gastronomia
Winkelmesser
Couteau à gastronomie
Cuchillo gastronomía

art. cm.
18215-13 13,5



Baking pan knife
Coltello gastronomia
Winkelmesser
Couteau à gastronomie
Cuchillo gastronomía

art. cm.
18215-21 21,5



Farinata knife
Coltello per farinata
Farinata Messer
Couteau à Farinata
Cuchillo Farinata

art. cm.
42830-08 8



Pie knife
Coltello torta
Tortenmesser
Couteau à gâteau
Cuchillo para tartas

art. cm.
18514-18 18



Mincing knife
Mezzaluna
Wiegemesser
Hachoir
Media luna

art. cm.
48017-14 14
48017-25 26



Double blade mincing knife
Mezzaluna, lama doppia
Wiegemesser, Doppel-Klinge
Hachoir double lame
Media luna, doble

art. cm.
48215-14 14
48215-30 30



Steak/pizza knife

Coltello bistecca/pizza
Steak-/Pizzamesser
Couteau à steak/pizza
Cuchillo para steak/pizza

art.	cm.	U. Pack
18218-12	12	6



Meat fork

Forchettone
Fleischgabel
Fourchette diapason
Tenedor para carne

art.	cm.	col.
18226-17	17	● ○ ● ● ● ● ●



Sharpening steel

Acciaino
Wetzstahl
Fusil à affûter
Afilador

art.	cm.	col.
18235-26	26	●
18235-30	30	● ○ ● ● ● ● ●



Oval sharpening steel

Acciaino ovale
Wetzstahl, oval
Fusil à affûter, ovale
Afilador ovalado

art.	cm.
18236-30	30



Diamond sharpening steel

Acciaino diamantato
Diamant-Wetzstahl
Fusil à affûter, diamant
Afilador adiamantado

art.	cm.
18237-26	26



Sharpening stone GRIT 1000/240

Pietra per affilare
Abziehstein
Pierre à aiguiser
Piedra para afilar

art.	cm.
18251-01	21x7x3



Sharpening stone GRIT 1000/600

Pietra per affilare
Abziehstein
Pierre à aiguiser
Piedra para afilar

art.	cm.
18251-02	21x7x3

JAPANESE SUSHI KNIVES

COLTELLI SUSHI GIAPPONESI

KNIVES
COLTELLERIA



Excellent choice when preparing sushi and vegetables. Molybdenum/Vanadium s/s blades for excellent edge retention, razor sharp edges, slip resistant wooden handles. The blades are sharpened with the traditional Japanese single bevel to improve sharpness. The large beveled one-sided edge is much thinner than a two-sided edge. This thinner, sharper edge makes for cleaner cuts through the soft flesh of fish, in particular. Using these knives will avoid bruising the delicate texture of raw fish and destroying the freshness of the fish. The thinner edge is more fragile than the edge on western knives. Do not use for cutting anything solid including larger fish bones. Due to the special blade sharpening and s/s used we highly recommend to only hand wash and dry the blades thoroughly immediately.

Una scelta eccellente per la preparazione di sushi e verdure. Lame in acciaio inox, molibdeno e vanadio, per un'ottimale tenuta del filo, affilatura a rasoio, manici in legno antiscivolo. Secondo la tradizione giapponese l'affilatura è unilaterale ed il filo è molto più sottile rispetto a quello della normale affilatura dei coltelli occidentali. Questo rende i tagli più nitidi ed evita di creare traumi alla trama delicata di carne e pesce crudo. Non utilizzare per il taglio di solidi incluse grosse lisce di pesce. Data la particolarità dell'affilatura e dell'acciaio impiegato si consiglia vivamente di lavare a mano ed asciugare immediatamente con cura le lame.



DEBA

art.	l. cm.
18280-22	22,5
18280-16	16,5
18280-10	10,5

The Deba is a powerful knife used for filleting fish and butchering meat without bones. Its weight and thickness can chop through fish bones and the sharp edge can fillet even the smallest of fish. – Affilato e dalla lama pesante usato per disossare e tagliare il pesce utilizzato nel sushi. È simile ad un coltello da chef.



OROSHI

art.	l. cm.
18281-24	24

An Oroshi Knife is a Japanese all-purpose cooking knife, but used particularly for fish. – Per sfilettare il tonno e altri pesci di grandi dimensioni.



USUBA

art.	l. cm.
18282-22	22,5
18282-18	18,0
18282-19*	18,0

***Double bevel. The Usuba is the ultimate vegetable knife. Sharp and thin, it is used by chefs in Japan for katsuramuki, a traditional style of peeling vegetables into thin sheets.** – *Doppia affilatura. Coltello estremamente affilato con una punta quadrata. Questo coltello è usato per tagliare verdure e quando è tenuto ben affilato può tagliarle in fette sottili come un foglio di carta.



TAKO SASHIMI

art.	l. cm.
18283-33	33
18283-27	27

The Tako Sashimi is a variation of the Yanagi and is used to slice straight-cut sashimi. The blunt tip and balanced weight works well on difficult ingredients like octopus, from which it gets its name. Originated in Kanto (Tokyo) region. – Il coltello Tako Sashimi assomiglia di più ad un coltello occidentale ed è utilizzato per affettare tagli spessi di carne per sushi. Ha la lama senza punta, per evitare di rovinare i tentacoli del polpo.



YANAGI SASHIMI

art.	l. cm.
18284-21	21
18284-27	27
18284-30	30
18284-33	33

The Yanagi Sashimi is a slicing knife used to cut boneless fish fillets into sashimi and topping for sushi. The graceful, thin blade cuts beautiful slices in one long, drawing stroke. Originated in Kansai (Osaka) region. – Viene utilizzato per tagliare sottili fette di verdure, carne o pesce, nonché per tagliare in generale a dadi o a fette. Grazie alla sua lama sottile ed affilata è utilizzato anche per creare guarnizioni o tagliare i rotoli di sushi.

SCISSORS
FORBICI



Seafood scissors
Forbice per gamberi
Meeresfrüchteschere
Ciseaux à crevettes
Tijeras para camarónes

art. cm.
18278-00 18



Kitchen scissors
Forbice multiuso
Küchenschere
Ciseaux cuisine
Tijeras de cocina, multiuso

art. cm.
18272-00 18,5



Herb scissors 5 blades

Forbice per erbe, 5 lame
Kräuterschere 5 Klingen
Ciseaux à herbes 5 lames
Tijeras hierbas 5 cuchillas

art. cm.
18277-00 20



Divisible kitchen scissors

Forbice da cucina, smontabile
Küchenschere, teilbar
Ciseaux cuisine, divisible
Tijeras de cocina, desmontables

art. cm.
18271-00 22,6



Divisible kitchen scissors

Forbice da cucina, smontabile
Küchenschere, teilbar
Ciseaux cuisine, divisible
Tijeras de cocina, desmontables

art. cm.
18273-00 18



Divisible kitchen scissors

Forbice da cucina, smontabile
Küchenschere, teilbar
Ciseaux cuisine, divisible
Tijeras de cocina, desmontables

art. cm.
18274-00 20



Divisible pizza scissors

Forbice pizza, smontabile
Pizzaschere, teilbar
Ciseaux pizza, divisible
Tijeras para pizza, desmontables

art. cm.
18276-00 25



Quail egg cutter

Forbice per uova di quaglia
Wachteleier-Schere
Ciseaux oeufs de caille
Tijeras huevos de codorniz

art. cm.
18279-14 14

NEW



Salad scissors

Forbice insalata
Salatschere
Ciseaux à salade
Tijeras para ensalada

art. cm.
18270-22 22

NEW



Divisible poultry shears

Trinciapollo, smontabile
Geflügelschere, teilbar
Coupe volailles, divisible
Tijeras para aves, desmontables

art. cm.
18261-00 24



Poultry shears

Trinciapollo
Geflügelschere
Coupe volailles
Tijeras para ave

art.	cm.
18263-00	25



Poultry scissors, divisible

Forbice pollame, smontabile
Geflügelschere, teilbar
Ciseaux à volaille, divisible
Tijeras para aves, desmontables

art.	cm.
18275-00	26,5



Chef's set, 14 pieces

Valigia cuoco, 14 pz.
Kochkoffer, 14 Stk.
Mallette de chef, 14 pièces
Maleta del Chef, 14 piezas

art.	des.
18099-15	Comprende/includes:
18000-26	cook's knife/cucina cm 26
18000-30	cook's knife/cucina cm 30
18002-18	butcher's knife/francese cm 18
18002-26	butcher's knife/francese cm 26
18009-30	ham/prosciutto cm 30
18016-16	boning/disosso cm 6
18024-11	paring/spelucchino cm 11
18026-07	paring/spelucchino cm 7
18028-30	bread/pane cm 30
18230-17	fork/forchettone cm 17
18235-30	sharpener/acciaino cm 30
18519-26	spatula/spatola cm 26
48280-34	peeler/pelapatate
18276-00	scissors/forbice pizza



Chef's set, 17 pcs

Valigia cuoco, 17 pz.
Kochkoffer, 17 Stk.,
Mallette de chef, 17 pcs
Maleta del Chef, 17 piezas

art.	des.
18199-19	Comprende/includes:
18100-24	cook's knife/cucina cm 24
18100-30	cook's knife/cucina cm 30
18112-30	salmon/salmone cm 30
18115-20	filleting/filettare cm 20
18116-14	boning/disosso cm 14
18125-10	paring/spelucchino cm 10
18126-07	bent paring/spelucchino cm 7
18128-30	bread/pane cm 30
18230-17	fork/forchettone cm 17
18235-30	sharpener/acciaino cm 30
18276-00	scissors/forbice pizza
18255-00	sharpener/affila coltelli
48280-25	apple corer/levatorsoli
48280-34	peeler/pelapatate
48280-02	can opener/apribottiglie
48280-27	melon baller/scavino
48280-92	striper/decora limoni



Knife roll-bag, 9 pieces forged

Rotolo portacoltelli, 9 pz. forgiati

Rolltasche, 9-teilig

Rouleau à couteaux, 9 pièces

Bolsa porta cuchillos, 9 piezas

art.	des.
18190-09	Comprende/includes:
18116-14	boning/disosso cm 9
18100-24	cook's/cucina cm 24
18106-25	slicer/affettare cm 25
18109-26	ham/prosciutto cm 24



art.	des.
18124-09	paring/spelucchino
18128-24	bread/pane cm 14
18230-17	fork/forchettone
18235-26	sharpener/acciaino
18271-00	scissors/forbice



Wood knife block, 9 pcs set

Ceppo porta coltelli legno, set 9 pz

Holz-Messerblock, 9-tlg.

Bloc à couteaux en bois, set 9 pièces

Bloque portacuchillos de madera, 9 piezas

art.	des.
18192-09	Comprende/includes:
18100-20	cook's/cucina cm 20
18106-20	slicer/affettare cm 20
18124-09	paring/spelucchino cm 9
18128-20	bread/pane cm 20



art.	des.
18230-17	fork/forchettone cm 17
18235-26	sharpener/acciaino cm 26
18271-00	scissors/forbice
18102-16	butcher's/francese cm 16
18126-07	paring/cuoco cm 7



Knife block, silicone

Ceppo porta coltelli, silicone

Messerblock, Silikon

Bloc à couteaux, silicone

Bloque portacuchillos, silicona

art.	Ø cm.	h. cm.
18191-22	10,5	22,5





Magnetic knife rack

Barra magnetica
Magnet-Messerhalter
Porte-couteaux magnetic
Barra magnética portas cuchillos

art.	cm.
48032-30	30
48032-45	45
48032-60	60



SS

E^{dlund}

Knife block

Ceppo porta coltelli
Messerblock
Bloc à couteaux
Bloque portacuchillos

art.	cm.
49875-06	26x14x33



SS

E^{dlund}

Knife rack

Porta coltelli
Messeraufhänger
Support à couteaux
Porta cuchillos

art.	cm.
48040-00	30,5x6,6x30,5
48040-AA	

Holds 8 chef 's knives, 2 smaller knives, 1 steel and scissors. – Per 8 coltelli cuoco, 2 coltelli piccoli, 1 acciaio e forbici.



48040-AA



SS

E^{dlund}

Knife rack

Porta coltelli
Messeraufhänger
Support à couteaux
Porta cuchillos

art.	cm.
48040-10	30,5x6,6x35,6
48040-AA	

Holds 8 chef 's knives, 2 smaller knives, 1 steel and scissors. – Per 8 coltelli cuoco, 2 coltelli piccoli, 1 acciaio e forbici.



SS

E^{dlund}

Knife rack

Porta coltelli
Messeraufhänger
Support à couteaux
Porta cuchillos

art.	cm.
48039-06	15,2x6,6x30,5

Holds 1 cleaver and 4 chef knives or 6 chef knives or 8 slicers or 12 paring knives and 1 round or diamond steel. – Per 1 mannaia e 4 coltelli cuoco o 6 coltelli cuoco o 8 coltelli affettare o 12 spelucchini e 1 acciaio tondo.



SS

E^{dlund}

Knife sanitizing system

Sterilizzatore ad immersione
Messerkentkeimer
Stérilisateur à couteaux
Esterilizador a inmersión

art.	cm.
48040-50	45,7x11,5x45,7



Manual sharpener

Affilacoltelli manuale
Messer Schleifapparat
Affûteur manuel
Afilador manual

art.
18255-00



Manual sharpener

Affilacoltelli manuale
Messer Schleifapparat
Affûteur manuel
Afilador manual

art.
49739-00



Salami pricker

Pungisalame
Salamistachel
Pique saucisson
Picadura pra embutido

art.
42523-00



SS

Larding needle, with flap

Ago lardellare, con becco
Spicknadel, mit Klappe
Lardoire à clapet

Aguja con clip

art.	Ø mm.	cm.
42514-20	5	20



SS

Lacing needle, straight

Ago da cucina
Dressiernadel, gerade
Aiguille à brider, droite

Aguja de cocina

art.	cm.
42515-18	18
42515-20	20



SS

Lacing needle, bent

Ago da cucina, curvo
Dressiernadel, gebogen
Aiguille à brider, courbe

Aguja de cocina

art.	cm.
42516-18	18
42516-20	20



SS

Needles 5 pcs set

Aghi set 5 pz
Nadelsatz, 5 Stk.
Aiguilles set 5 pcs
Agujas 5 pz

art.
42517-06



W

Skewers, 100 pcs

Spiedini, 100 pz
Fleischspieße, 100 Stk
Brochettes, 100 pcs
Palos para asar, 100 pz

art.	cm.
48307-01	15
48307-02	20
48307-03	25



SS

Skewers 6 pcs set

Spiedini set 6 pz
Fleischspieße, Satz 6 Stk
Brochettes set 6 pcs
Palos para asar 6 pz

art.	cm.
42529-06	30



Skewers flat, 18/8

Spiedini piatti, 18/8
Fleischspieße, flach, 18/8
Brochettes plates, 18/8
Pinchos planos, 18/8

art.	mm.	U. Pack
42511-20	200x3	10
42511-25	250x3	10
42511-30	300x3	10
42511-35	350x3	10
42511-40	400x3	10
42511-56	560x5	10



Swords, 18/8

Spade, 18/8
Schwörter, 18/8
Epées, 18/8
Espadas, 18/8

art.	mm.
42511-60	600x15x3
42511-70	700x15x3



SS

Anchor meat hook

Gancio ad ancora
Anker Fleischhaken
Esse à ancre
Gancho forma ancla

art.	Ø mm.	cm.	U. Pack
42507-12	7	13	10



SS

Sliving meat hook

Gancio girevole
Fleischdrehhaken
Esse-tournante
Gancho giratorio

art.	Ø mm.	cm.	U. Pack
42525-27	12	27	10



SS

Meat hook, 2 peacks

Gancio fisso, 2 punte
Fleischhaken, 2 Spitze
Crochet esse, 2 pointes
Gancho 2 puntas

art.	Ø mm.	cm.	U. Pack
42524-06	3	6	10
42524-08	4	8	10
42524-10	4	10	10
42524-12	5	12	10
42524-14	5	14	10
42524-16	6	16	10
42524-18	6	18	10
42524-20	9	20	10
42524-22	9	22	10
42524-30	12	30	10



SS

Meat hook, 1 peack

Gancio fisso, 1 punta
Fleischhaken, 1 Spitze
Crochet esse, 1 pointe
Gancho 1 punta

art.	Ø mm.	cm.	U. Pack
42506-08	3	8	10
42506-10	4	10	10
42506-12	5	12	10
42506-14	5	14	10
42506-16	6	16	10
42506-18	6	18	10



SS

Swivel meat hook

Gancio girevole
Fleischdrehhaken
Esse-tournante
Gancho giratorio

art.	Ø mm.	cm.
42505-21	9	22
42505-24	10	26
42505-27	12	28
42505-50	12	50



SS

Sliding meat hook

Gancio scorrevole
Fleischhaken
Crochet coulissant
Gancho

art.	Ø mm.	cm.	U. Pack
42526-12	9	12	10
42526-14	12	14	10



SS

Ham-tong

Pinza per affettati
Schinkenlange
Pince à jambon
Pinza para jamón

art.	cm.
42510-00	11x6



SS

Meat tenderizer

Batticarne a pugno
Kotelettklopfen
Aplatisseur
Aplasta carnes

art.	Kg.
42501-15	1,5
42501-20	2,0



SS

Meat tenderizer

Batticarne a due tagli
Kotelettklopfen
Aplatisseur
Aplasta carnes

art.	Kg.
42502-11	1,1



SS

Meat tenderizer

Batticarne a paletta
Kotelettklopfen
Aplatisseur
Aplasta carnes

art.	Kg.
42503-10	1



Steak hammer, aluminum

Batticarne, alluminio
Aluminum-Fleischklopfer
Attendrisseur, alu
Aplasta carnes, aluminio

art.	cm.	Kg.
42508-00	32	0,6



Steak hammer, aluminum

Batticarne, alluminio
Aluminum-Fleischklopfer
Attendrisseur, alu
Aplasta carnes, aluminio

art.	cm.	Kg.
42508-01	25	0,41



SS

Bone-saw

Sega per ossa
Knochensäge
Scie à os
Sierra de cocina

art.	cm.
48231-40	40
48231-45	45
48231-50	50



SS

String holder

Portaspago
Schnurrolle-Halter
Porte rolls sur socle
Porta cuerda

art.	cm.
42579-00	19x12x17



SS

Meat pan

Vassoio rettangolare
Fleischblech
Plat boucher
Bandeja rectangular

art.	cm.
42534-26	26x23x2
42534-32	34x21x2
42534-41	45x25x2



SS

Display tray

Vassoio espositore
Ausstellplatte
Plateau
Bandeja expositora

art.	cm.
42532-29	29x21x2
42532-58	58x21x2



SS

Meat pan

Vassoio
Fleischblech
Plat boucher
Contenedor

art.	cm.
42530-26	24,4x21,6x5,5
42530-32	32x23x5,5
42530-41	41x31x5,5
42530-50	50x35x5,5



SS

Meat pan with grid

Vassoio con griglia
Fleischblech mit Siebeinsatz
Plat boucher avec grille
Contenedor con rejilla

art.	cm.
42531-26	24,4x21,6x5,5
42531-32	32x23x5,5
42531-41	41x31x5,5
42531-50	50x35x5,5



Ham stand on wood

Ferma prosciutto base legno
Schinkenhalter, Holzsockel
Pince à jambon sur bois
Jamonero, base madera

art.	cm.	Kg.
41582-00	24x45x16	4,5



Ham stand on marble

Ferma prosciutto base marmo
Schinkenhalter, Marmorsockel
Pince à jambon sur marbre
Jamoneiro, base mármol

art.	cm.	Kg.
41583-00	24x45x15	10,3



SS

Hamburger press

Pressa-hamburger
Hamburgerpresse
Moule à steak
Prensa para hamburguesa

art.	Ø cm.	l. cm.
42864-10	10	36



Hamburger press, anodized aluminum

Pressa-hamburger, alluminio anodizzato
Hamburgerpresse, Aluminium eloxiert
Moule à steak, aluminium anodisé
Prensa para hamburguesa, aluminio anodizado

art.	cm.	Kg.
49978-10	37x25x50	5,0
49978-13	42x27,5x53	5,5

The parts coming into contact with food are in stainless steel. – Parti a contatto con il cibo in acciaio inox per alimenti.



Vertical manual sausage filler

Insacatrice verticale
Wurstfüller
Poussoir manuel vertical
Enscadora vertical

art.	cm.	lt.	Kg.
49876-03	30x22x47,5	3	6,2

With 3 funnels. – Con 3 imbuti.



Slicer

Affettatrice
Aufschnitt-Maschine
Trancheur
Cortadora

art.	Ø cm.	cm.	Kg.
49971-25	25	68x52x51	33

Cut thickness range mm 0÷2,3. 9 cutting positions. Cut cm 18,5x51. – Spessore taglio mm. 0÷2,3. 8 scatti. Taglio utile cm 18,5x15.



Slicer

Affettatrice
Aufschnitt-Maschine
Trancheur
Cortadora

art.	Ø cm.	cm.	Kg.
49972-30	30	72x60x74	45,5

Cut thickness range mm 0÷2,5. 9 cutting positions. Cut cm 23x19. – Spessore taglio mm. 0÷2,5. 9 scatti. Taglio utile cm 23x19.



Slicer

Affettatrice
Aufschnitt-Maschine
Trancheur
Cortadora

art.	Ø cm.	des.
49971R25	25	Rose
49971M25	25	Daisy
49972R30	30	Rose
49972M30	30	Daisy



Stand

Piedistallo
Sockel
Piédestal
Pedestal

art.	cm.
49971P25	65x80
49972P30	65x80



Stand with wheels

Piedistallo con ruote
Sockel mit Rädern
Piédestal avec roues
Pedestal con ruedas

art.	cm.
49971R00	65x80



Block brush, plastic handle

Spazzola per ceppa
Blockbürste, Kunststoffgriff
Brosse à billot, matière plastique
Cepillo para cepa

art.	cm.
42518-01	20



PE

Cutting board with tray

Tagliere con vasca
Tranchierbrett mit Tablett
Planche à découper avec plateau
Tabla de corte con bandeja

art.	cm.
44947-00	33,5x46x5,5



HDPE

Cutting board

Tagliere bar
Tranchierbrett
Planche à découper
Tabla de corte

art.	cm.
42521-16	16x24,5x1
42521-24	24,5x32,5x1



03 = RED / ROSSO
Raw meat and poultry
Carni crude
Rohes Fleisch
Viande crue
Carne cruda



02 = BROWN / MARRONE
Raw vegetables
Verdure crude
Rohes Gemüse
Crudités
Verduras crudas



04 = BLUE / BLU
Raw fish
Pesce
Fisch
Poisson
Pescado



01 = YELLOW / GIALLO
Cooked meats
Carni cotte
Gekochtes Fleisch
Viande cuite
Carne cocida



05 = GREEN / VERDE
Salads and fruits
Insalata e frutta
Salat und Früchte
Salade et fruits
Ensalada y fruta



00 = WHITE / BIANCO
Bakery and dairy products
Pane e formaggi
Brot und Käse
Pain et fromages
Pan y quesos



ALLERGENS

07 = VIOLA / VIOLET
Gluten Free
Casher
Hallal
Vegan



HDPE

Cutting board

Tagliere bar
Tranchierbrett
Planche à découper
Tabla de corte

art.	cm.	GN	col.
42522-00	32x26,5x2	1/2	○
42522-01	32x26,5x2	1/2	●
42522-02	32x26,5x2	1/2	●
42522-03	32x26,5x2	1/2	●
42522-04	32x26,5x2	1/2	●
42522-05	32x26,5x2	1/2	●
42522-09	32x26,5x2	1/2	●



HDPE

Cutting board

Tagliere bar
Tranchierbrett
Planche à découper
Tabla de corte

art.	cm.	GN	col.
42538-00	53x32,5x2	1/1	○
42538-01	53x32,5x2	1/1	●
42538-02	53x32,5x2	1/1	●
42538-03	53x32,5x2	1/1	●
42538-04	53x32,5x2	1/1	●
42538-05	53x32,5x2	1/1	●
42538-09	53x32,5x2	1/1	●

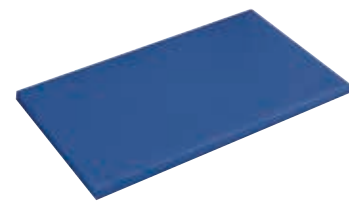

HDPE

Cutting board

Tagliere bar
Tranchierbrett
Planche à découper
Tabla de corte

art.	cm.	col.
42539-00	60x40x2	○
42539-01	60x40x2	●
42539-02	60x40x2	●
42539-03	60x40x2	●
42539-04	60x40x2	●
42539-05	60x40x2	●
42539-09	60x40x2	●



HDPE

Cutting board

Tagliere bar
Tranchierbrett
Planche à découper
Tabla de corte

art.	cm.
42522-07	32x26,5x2
42538-07	53x32,5x2
42539-07	60x40x2



HDPE

Cutting board

Tagliere bar
Tranchierbrett
Planche à découper
Tabla de corte

art.	cm.
42537-40	40x30x2
42537-50	50x30x2
42537-80	80x40x2



HDPE

Cutting board with groove

Tagliere con canalina
Tranchierbrett mit Kanal
Planche à découper avec rigole
Tabla de corte con ranura

art.	cm.	GN	col.
42546-00	65x53x2	2/1	○
42546-01	65x53x2	2/1	●
42546-02	65x53x2	2/1	●
42546-03	65x53x2	2/1	●
42546-04	65x53x2	2/1	●
42546-05	65x53x2	2/1	●



HDPE

Cutting board with stoppers

Tagliere con fermi
Tranchierbrett mit Stiften
Planche à découper avec arrêts
Tabla de corte con barras de la parada

art.	cm.	GN	col.
42543-00	53x32,5x2	1/1	○
42543-01	53x32,5x2	1/1	●
42543-02	53x32,5x2	1/1	●
42543-03	53x32,5x2	1/1	●
42543-04	53x32,5x2	1/1	●
42543-05	53x32,5x2	1/1	●



HDPE

Cutting board with stoppers

Tagliere con fermi
Tranchierbrett mit Stiften
Planche à découper avec arrêts
Tabla de corte con barras de la parada

art.	cm.	col.
42544-00	60x40x2	○
42544-01	60x40x2	●
42544-02	60x40x2	●
42544-03	60x40x2	●
42544-04	60x40x2	●
42544-05	60x40x2	●



HDPE

Cutting board with stoppers

Tagliere con fermi
Tranchierbrett mit Stiften
Planche à découper avec arrêts
Tabla de corte con barras de la parada

art.	cm.
42540-40	40x30x2
42540-50	50x30x2
42540-80	80x40x2



HDPE

Colored cutting boards set 6 pcs

Taglieri colorati set 6 pz
Tranchierbretter 6 Stk.
Planches à découper set 6 pcs
Juego 6 tablas de corte

art.	cm.
42541-06	46x31x1,3



HDPE

Round cutting board

Tagliere tondo
Tranchierbrett, rund
Planche à découper, ronde
Tabla de corte redonda

art.	Ø cm.	h. cm.
42535-24	24,0	1,0
42535-32	32,5	1,5
42535-49	49,0	1,5



HDPE

Butchers table

Ceppa
Hackblock
Billot
Cepa

art.	cm.	mm.
42518-50	50x50x86	4*

*Thickness. – Spessore.



HDPE

Worktop

Ceppo
Arbeitsplatte
Plan de travail
Encimera

art. cm. mm.
42519-01 50x50 4*

*Thickness. – Spessore.



HDPE

Board scraper

Raschietto
Blockschäber
Racloir à planches
Rascador

art. cm.
42520-00 17x6x9

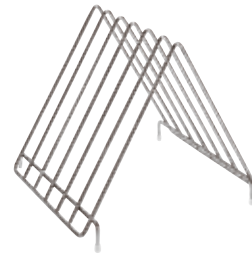

SS

Cutting board rack

Portataglieri in filo
Tranchierbretter-Träger
Sechoir à plaques à découper
Porta tablas

art. cm.
42542-00 30x26x27,5



W

Bread cutting board

Tagliere pane
Brotschneidbrett
Planche à découper
Tabla de corte

art. cm.
42964-53 53x32,5x2
42964-60 60x40x2



Chainmail glove

Guanto in cotta di maglia
Fingerhandschuhe
Gant en cotte de mailles
Guante de malla

art. size/T. col.
48505-01 Small ○
48505-02 Medium ●
48505-03 Large ●

Fits either hands, made of stainless steel AISI 316 L, welded rings - external ø of the rings 4 mm - wire ø 0,5 mm, nylon strap.

Ambidestro, in acciaio AISI 316 L, anelli saldati, ø esterno 4 mm - ø del filo 0,5 mm, cinturino nylon.



Chainmail glove, extended cuff

Guanto lungo in cotta di maglia
Fingerhandschuhe, lang
Gant en cotte de mailles, manchette longue
Guante largo de malla

art. size/T. col.
48506-01 Small ○
48506-02 Medium ●
48506-03 Large ●

Fits either hands, made of stainless steel AISI 316 L, welded rings - external ø of the rings 4 mm - wire ø 0,5 mm, nylon strap.

Ambidestro, in acciaio AISI 316 L, anelli saldati, ø esterno 4 mm - ø del filo 0,5 mm, cinturino nylon.



Protective apron

Grembiule di protezione
Schutzschürze
Tablier de protection
Delantal de protección

art. cm.
48501-76 75x55

EN ISO 13998 - Livello/Level 2 - Aluminum plates mm 20x19x0,8, stainless steel ring links ø 1 mm. Belt fastening with textile adjustable and detachable straps.

Piastrine in alluminio mm 20x19x0,8 collegate da anelli in acciaio inossidabile ø 1 mm. Dotato di bretelle regolabili e staccabili.



Oven mitt

Guanto da forno
Ofenhandschuh
Moufle de déformement
Manopla de protección

art. l. cm.
48510-00 28

Outer fabric 100% cotton with silver coating, 100 g/mq. – Tessuto esterno 100% cotone con rivestimento argenteo 100 g/mq.



Oven mitt, silicone

Guanto da forno, silicone
Backhandschuhe, Silikon
Gant de protection, silicone
Manopla de protección, silicona

art.
48514-00

Ambidextrous. Contact heat resistant up to +300°C for 15 seconds. Non-slip, water and oil tight, dishwasher safe.

Ambidestro. Resistenza al calore per contatto fino a 300°C per 15 secondi. Stagno all'acqua e agli oli bollenti, lavabile in lavastoviglie.



Cut resistant glove

Guanto anti taglio
Schnittschutz-Handschuh
Gant anti-coupures
Guante de protección

art.	size/T.
48523-01	S
48523-02	M
48523-03	L
48523-04	XL

Spectra fiber glove, fine weave knit, cut resistance maximum level (EN388: level 5), washable up to 95 °C, ambidextrous.

Guanto in fibra spectra in maglina a trama fine, resistenza al taglio livello massimo (EN388: livello 5), lavabile fino a 95°C, ambidestro.



Three-finger oven glove

Guanti anticalore a 3 dita
Backhandschuhe, 3 Finger
Moufles protection thermique, 3 doigts
Guantes de protección

art.	l. cm.
48517-03	35,5

Resistant to abrasion, tears and cuts. CE marking, in accordance to the basic requirements concerning health and security of the European Directives 89/686/C.E.E. Contact heat resistant up to +350°C for 20 seconds.

Resistenti all'abrasione, agli strappi ed ai tagli. Marcati CE, rispettano i requisiti essenziali di salute e sicurezza secondo le direttive europee 89/686/C.E.E. Hanno una resistenza al calore per contatto fino a 350°C per 20 secondi.



Oven mitts

Guanti da forno
Backhandschuhe
Moufles de défournement
Manoplas de protección

art.	cm.
48511-02	34x16

Special cotton fabric, natural color, reinforced palm and thumb. Heat resistant up to +200°C. Machine washable up to +40°C.

In cotone speciale, colore naturale, esecuzione rinforzata palmo e pollice. Resistente fino a +200°C. Lavabile in lavatrice max. 40°C.



Oven mitts

Guanti da forno
Backhandschuhe
Moufles de défournement
Manoplas de protección

art.	cm.
48513-02	26x14,5

Special cotton fabric, natural color, reinforced palm and thumb. Heat resistant up to +200°C. Machine washable up to +40°C.

In cotone speciale, colore naturale, esecuzione rinforzata palmo e pollice. Resistente fino a +200°C. Lavabile in lavatrice max. 40°C.



Oven mitts

Guanti da forno
Backhandschuhe
Moufles de défournement
Manoplas de protección

art.	cm.
48512-02	27x15

Special cotton fabric, natural color, reinforced palm and thumb. Heat resistant up to +200°C. Machine washable up to +40°C.

In cotone speciale, colore naturale, esecuzione rinforzata palmo e pollice. Resistente fino a +200°C. Lavabile in lavatrice max. 40°C.



Oven glove, nitrile

Guanti anticalore, nitrile
Backhandschuhe, Nitril
Moufles protection thermique, nitrile
Guantes de protección, nitrile

art.	l. cm.	size/T.
48515-09	45	9
48515-11	45	11
48515-12	45	12

Contact heat protection up to 150°C. Resistance to oils, grases and main detergents. Washable inside and outside.

Protezione al calore da contatto fino a 150°C. Resistenza agli oli, ai grassi e ai principali detersivi. Lavabili all'interno e all'esterno.



Scrubbing gloves

Guanti scrub
Schrubben Handschuhe
Gants à scrubbing
Guantes para fregar

art.	size/T.
48518-01	one size



Scrubbing gloves

Guanti scrub
Schrubben Handschuhe
Gants à scrubbing
Guantes para fregar

art.	size/T.
48518-02	one size



Sugar gloves

Guanti in lattice
Zucker-Handschuhe
Gants à tirer le sucre
Guantes de látex

art.	size/T.
48516-07	7 – 7 1/2
48516-08	8 – 8 1/2
48516-09	9 – 9/1/2



Blue gloves, nitrile

Guanti blu, nitrile
Blau-Handschuhe, Nitril
Gants en nitrile, bleu
Guantes azules, nitrile

art.	pcs/pz	size/T.
48519-01	100	S
48519-02	100	M
48519-03	100	L
48519-04	100	XL

Treatment Powder free. Latex-free. Finish microgrip. – Trattamento Powder free. Latex free. Finitura Microgrip.



HDPE

Gloves

Guanti
Handschuhe
Gants
Guantes

art.	l. cm.	pcs/pz	size/T.
48522-24	24	500	one size

Palm and fingers microgrip finishing.
Finitura palmo e dita microgrip.



Paper Chef hat

Cappello Grand Chef, carta
Kochmütze, Papier
Toque papier
Tocado, papel

art.	h. cm.	pcs/pz
48520-20	20	20
48520-23	23	20
48520-30	30	20

Double crepe paper processing, absorbent, adjustable size, ventilated.

Carta crespata doppia lavorazione, fascia assorbi sudore, adesivo regolabile, areato.



Apron, LDPE

Grembiule LDPE
Schurz, LDPE
Tablier, LDPE
Delantal, LDPE

art.	cm.	pcs/pz
48524-75	75x120	50

Waterproof and resistant, length 120 cm from the chest, total length 140 cm.

Impermeabile e resistente, lunghezza 120 cm dal petto, totale 140 cm.



Chef's hat, TNT

Cappello Monsieur Chef, TNT
Chef-Kochmütze, tnt
Toque plissée chef, TNT
Gorro Chef, TNT

art.	pcs/pz
48529-00	20

Tnt-polypropylene, pleated, band absorb sweat, adjustable adhesive to fix the size.

Tnt-polipropilene, plissettato, fascia assorbi sudore, adesivo regolabile per fissare la taglia.



Paper cap

Bustina carta
Papier Mütze
Calot papier
Gorro barco papel

art.	pcs/pz
48528-00	100

Double paper processing, absorbent, adjustable size, ventilated. – Carta doppia lavorazione, fascia assorbi sudore, adesivo regolabile, aerata.



Cap, TNT

Cuffia, TNT
Einweghauben, TNT
Charlotte, TNT
Cubrecabezas, TNT

art.	pcs/pz
48527-00	100

Pleated cap, TNT 16gr/m2, very light, soft elastic, ø 50 cm. – Cuffia plissettata TNT 16gr/m2, molto leggera, morbido elastico, ø 50 cm.



Visitor kit, TNT

Kit visitatore, TNT
Besucher-Kits, TNT
Kit visiteur, TNT
Conjunto visitador, TNT

art.	pcs/pz
48525-03	

1 TNT overall and cap, 1 CPE overshoes.
1 camice e cuffia in TNT e 1 set copriscarpe CPE.



PE

Overshoes

Copriscarpe
Überschuhe
Sur-chaussures
Cubrezapatos

art.	l. cm.	pcs/pz
48526-44	44	110

PE double-thickness, waterproof, elastic ankle, embossed bottom. – PE doppio spessore, impermeabili, elastico alla caviglia, fondo gofrato.

PASTRY PASTICCERIA

EQUIPMENT
ATTREZZATURE





Alphabet pcs 26
Alfabeto pz 26

art.	Ø cm.	h. cm.
47301-12	12	2



Numbers pcs 10
Numeri pz 10

art.	Ø cm.	h. cm.
47302-10	10	2

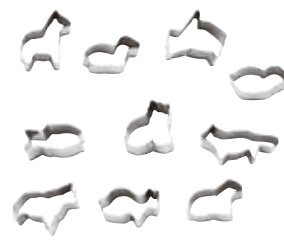

Animals pcs 10
Animali pz 10

art.	Ø cm.	h. cm.
47303-10	10	2

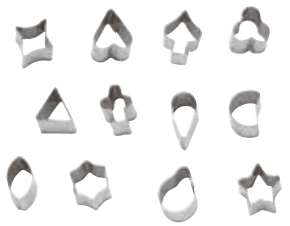

Shapes pcs 12
Sagome pz 12

art.	Ø cm.	h. cm.
47304-06	6,5	2

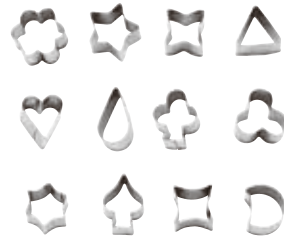

Shapes pcs 12
Sagome pz 12

art.	Ø cm.	h. cm.
47304-10	10	2



Shapes pcs 12
Sagome pz 12

art.	Ø cm.	h. cm.
47304-12	12	2



Shapes pcs 12
Sagome pz 12

art.	Ø cm.	h. cm.
47305-12	12	2



Flower pcs 6
Fiore pz 6

art.	Ø cm.	h. cm.
47306-10	10	3

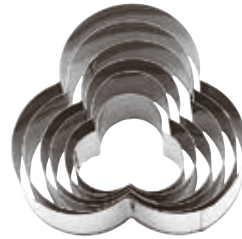

Trio pcs 6
Trio pz 6

art.	Ø cm.	h. cm.
47307-10	10	3



Heart pcs 6
Cuore pz 6

art.	Ø cm.	h. cm.
47308-10	10	3



Star pcs 6
Stella pz 6

art.	Ø cm.	h. cm.
47310-10	10	3



Halfmoon pcs 6
Mezzaluna pz 6

art.	Ø cm.	h. cm.
47312-10	10	3



Hexagon pcs 6
Esagono pz 6

art.	Ø cm.	h. cm.
47314-10	10	3

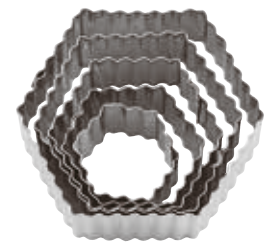

Hexagon, fluted pcs 5
Esagono festonato pz 5

art.	Ø cm.	h. cm.
47315-10	10	3,5

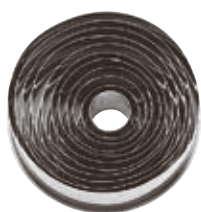

Ring pcs 11
Anello pz 11

art.	Ø cm.	h. cm.
47316-10	10	3



Ring pcs 14
Anello pz 14

art.	Ø cm.	h. cm.
47316-12	12	3



Ring pcs 20
Anello pz 20

art.	Ø cm.	h. cm.
47316-20	20	2,5



Ring, fluted pcs 11
Anello festonato pz 11

art.	Ø cm.	h. cm.
47317-10	10	3



Ring, fluted pcs 14
Anello festonato pz 14

art.	Ø cm.	h. cm.
47317-12	12	3



Ring, fluted pcs 20
Anello festonato pz 20

art.	Ø cm.	h. cm.
47317-20	20	2,5



Drop pcs 6
Goccia pz 6

art.	Ø cm.	h. cm.
47321-12	12	3

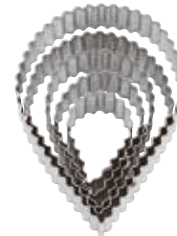

Drop, fluted pcs 5
Goccia festonata pz 5

art.	Ø cm.	h. cm.
47322-12	12,5	3,5



Square pcs 6
Quadro pz 6

art.	Ø cm.	h. cm.
47323-12	12	3



Square, fluted pcs 6
Quadro festonato pz 6

art.	Ø cm.	h. cm.
47324-12	12,5	3,5

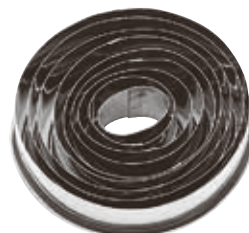

Oval pcs 9
Ovale pz 9

art.	Ø cm.	h. cm.
47326-10	10	3,5

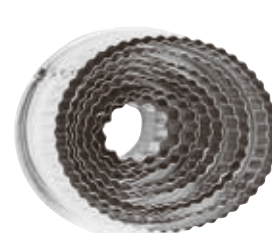

Oval, fluted pcs 9
Ovale festonato pz 9

art.	Ø cm.	h. cm.
47325-10	10	3,5



Fruit pcs 12
Frutta pz 12

art.	Ø cm.	h. cm.
47327-12	12,5	2



Animals pcs 10
Animali pz 10

art.	Ø cm.	h. cm.
47328-15	15	2



Vehicles pcs 7
Veicoli pz 7

art.	Ø cm.	h. cm.
47331-15	15	2



Vegetable pcs 12
Verdura pz 12

art.	Ø cm.	h. cm.
47332-12	12,5	2



Christmas pcs 7
Natale pz 7

art.	Ø cm.	h. cm.
47333-15	15	2



Easter pcs 6
Pasqua pz 6

art.	Ø cm.	h. cm.
47334-12	12,5	2



Stars pcs 7
Stelle pz 7

art.	Ø cm.	h. cm.
47335-12	12,5	2



Shapes pcs 10
Sagome pz 10

art.	Ø cm.	h. cm.
47419-10	20	3,5



Shapes pcs 42
Sagome pz 42

art.	Ø cm.
47336-42	6>22



Plain ring pcs 3
Anello liscio pz 3

art.	Ø cm.	h. cm.
47414-03	6-7-8	3



Fluted ring pcs 3
Anello festonato pz 3

art.	Ø cm.	h. cm.
47415-03	6-7-8	3



Canestrello
Canestrello

art.	Ø cm.	h. cm.
47416-06	6	3



Canestrello, fluted
Canestrello festonato

art. Ø cm. h. cm.
47417-06 6 3



Wheel
Ruota

art.
47418-00



CHRISTMAS
NATALE



Skeleton
Scheletro

art. cm.
47370-08 6x8x3



Angel
Angelo

art. cm.
47377-08 7x7x3



Snowman

Pupazzo di neve
art. cm.
47378-08 4x8x3



Reindeer
Renna

art. cm.
47379-08 8x7x3



Star
Stella

art. cm.
47411-08 8x8x3

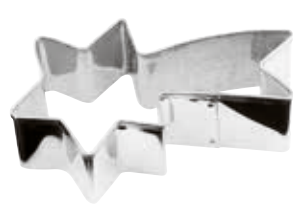

Comet
Stella cometa

art. cm.
47412-08 8x4x3



Christmas tree
 Albero di Natale

art. cm.
 47413-08 8x8x3



Pine

Pino
 art. cm.
 47413-01 6,4x8x3



Snowflake

Fiocco di neve
 art. cm.
 47411-01 7,4x8,6x3



Snowflake

Fiocco di neve
 art. cm.
 47411-02 7x8x3



Snowflake
 Fiocco di neve

art. cm.
 47411-03 8,5x8x3



Christmas, set of 6 pcs.

Natale set 6 pz
 art. cm.
 47387-01 8x8x3



EASTER
PASQUA



Rabbit
 Coniglio

art. cm.
 47372-08 8x4x3



Rabbit
 Coniglio

art. cm.
 47402-08 8x5x3



Rabbit
 Coniglio

art. cm.
 47402-01 7x8,5x3





Rabbit

Coniglio

art. cm.
47402-02 7,5x7x3



Bell

Campana

art. cm.
47373-08 6x7x3



Lamb

Agnellino

art. cm.
47376-08 8x7x3



Dove

Colomba

art. cm.
47382-08 8x7x3



Egg

Uovo

art. cm.
47373-01 5,6x8x3

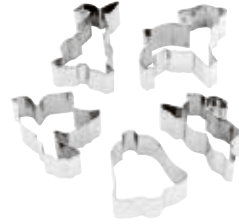

Easter, set of 5 pcs.

Pasqua set 5 pz

art. cm.
47387-02 8x8x3



HALLOWEEN



Skeleton

Scheletro

art. cm.
47370-08 6x8x3



Pumpkin

Zucca

art. cm.
47377-09 9x8x3



Pumpkin

Zucca

art. cm.
47377-10 8x8x3



Crescent

Mezzaluna

art. cm.
47377-01 6,2x8x3



Owl

Gufo

art. cm.
47377-02 4,7x8,3x3



Ghost

Fantasma

art. cm.
47377-03 8x8,4x3



Witch

Strega

art. cm.
47377-04 9x9,5x3



Witch hat

Cappello strega

art. cm.
47377-05 8,5x13x3



Witch on broom

Strega su scopa

art. cm.
47377-06 11,6x12x3



Skull

Teschio

art. cm.
47377-07 8x8x3



Halloween, set of 3 pcs.

Halloween set 3 pz

art. cm.
47377-11 11x10,7x2



ANIMALS & VARIOUS
ANIMALI & VARI





Honey bee

Ape

art. cm.
47382-06 11,6x8x3

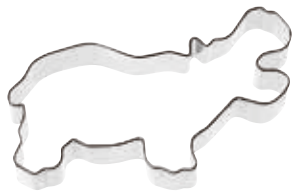

Hippo

Ippopotamo

art. cm.
47404-04 11x7x3



Ladybug

Coccinella

art. cm.
47404-05 8x8x3



Butterfly

Farfalla

art. cm.
47371-08 8x7x3



Snail

Lumaca

art. cm.
47404-02 11x6x3



Fish

Pesce

art. cm.
47384-08 8x8x3



Frog

Rana

art. cm.
47380-08 8x8x3



Rooster

Gallo

art. cm.
47383-08 8x8x3



Dolphin

Delfino

art. cm.
47384-01 5x9x3



Seagull

Gabbiano

art. cm.
47386-08 11x6x3



Cat

Gatto

art. cm.
47401-08 8x8x3



Goose

Oca

art. cm.
47404-08 8x7x3



Teddy bear

Orsetto

art. cm.
47375-08 8x8x3



Teddy bear

Orsetto

art. cm.
47375-01 6x9x3



Camel

Cammello

art. cm.
47404-01 9x8,6x3

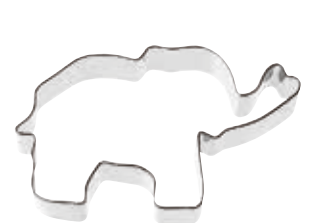

Elephant

Elefante

art. cm.
47404-03 12x7x3



Four leaf clover
Quadrifoglio

art. cm.
47374-08 8x8x3

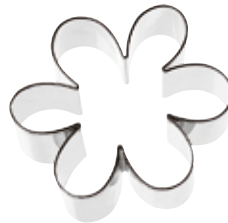

Flower
Fiore

art. cm.
47374-02 7x7,4x3



Tulip
Tulipano

art. cm.
47374-01 5,5x8x3



Heart
Cuore

art. cm.
47385-08 8x9x3



Two hearts
Due cuori

art. cm.
47385-01 9,4x5x3



Rocking horse
Cavallo a dondolo

art. cm.
47381-08 8x5x3



Bow
Fiocco

art. cm.
47373-02 6x8x3



Apple
Mela

art. cm.
47378-01 7,6x8,4x3



Pirate ship
Nave pirata

art. cm.
47370-03 8x8,4x3



Airplane
Aereo

art. cm.
47370-02 9x8x3

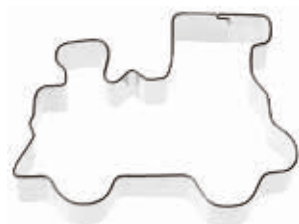

Train
Locomotiva

art. cm.
47370-01 10x7x3



Suits of cards, set of 4 pcs
Semi carte set 4 pz

art. cm.
47378-02 7,5x7,5x3





Numbers, set of 9 pcs

Numeri, set 9 pz

art. cm.

47421-09 6,5x2,5



Letters, set of 26 pcs

Lettere, set 26 pz

art. cm.

47422-26 6x2,5

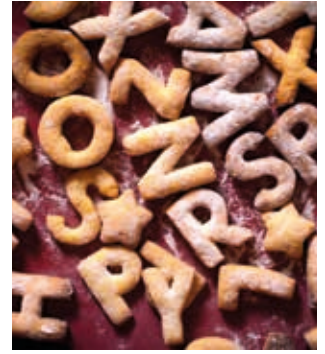

Round, set 6 pcs

Cerchio, set 6 pz

art. cm.

47425-01 4x3

47425-02 5x3

47425-03 6x3



Square, set 6 pcs

Quadro, set 6 pz

art. cm.

47425-04 5x5x3

47425-05 6x6x3



Triangle, set 6 pcs

Triangolo, set 6 pz

art. cm.

47425-06 6x3



Oval, set 6 pcs

Ovale, set 6 pz

art. cm.

47425-09 7,5x4,5x3



Trapeze, set 6 pcs

Trapezio, set 6 pz

art. cm.

47425-08 9x6x3



Rectangle, set 6 pcs

Rettangolo, set 6 pz

art. cm.

47425-10 5x3,5x3

47425-11 6x5x3



Drop, set 6 pcs

Goccia, set 6 pz

art. cm.

47425-26 9x3



Hexagon, set 6 pcs

Esagono, set 6 pz

art. cm.

47425-29 5x3

47425-30 6x3



Heart, set 6 pcs

Cuore, set 6 pz

art. cm.

47425-32 6,5x3



Square, set 6 pcs

Quadro, set 6 pz

art. cm.

47426-01 8x8x4,5



Rectangle

Rettangolo

art. cm.

47426-07 12x6x4,5



Doughnut cutter

Tagliapasta per doughnuts

Donut-Ausstecher

Coupe-donuts

Cortadonuts

art. Ø cm. h. cm.

47388-06 65-25 20

47388-07 70-30 17

47388-08 80-40 20



Cinnamon star cutter

Tagliapaste stelle

Zimtstern-Ausstecher

Coupe-étoiles

Cortapasta Esterella

art. cm.

47377-15 5x9,7

Spring mechanism. – Meccanismo a molla.



Horseshoe, tin plate

Ferro di cavallo, banda stagnata

Hufeisen, Weißblech

Fer à cheval, fer blanc

Herradura, hojalata

art. cm.

47377-12 7x6x2

CUTTERS
TAGLIAPASTA

PA+
plus



Round
Rotondo

art.	Ø cm.	h. cm.
12943-03	3	3,5
12943-05	5	3,5
12943-07	7	3,5
12943-08	8	3,5
12943-10	10	3,5
12943-12	12	3,5



Round, fluted
Rotondo festonato

art.	Ø cm.	h. cm.
12944-03	3	3,5
12944-05	5	3,5
12944-07	7	3,5
12944-08	8	3,5
12944-10	10	3,5
12944-12	12	3,5



Oval, fluted
Ovale festonato

art.	cm.
12947-02	5,5x3,5x4
12947-03	7x4x4
12947-04	8,5x5x4
12947-05	10x6x4
12947-06	11x7x4
12947-07	13x5x4



Set 6 pcs round pastry cutters
Scatola tagliapasta rotondi, 6 pz

art.
12943-13



Set 6 pcs fluted round pastry cutters
Scatola tagliapasta rotondi festonati, 6 pz

art.
12944-13



Set 6 pcs fluted oval pastry cutters
Scatola tagliapasta ovali festonati, 6 pz

art.
12947-13



Dough plunger cutters w/extractor, 3 pcs

Tagliapasta con espulsore, set 3 pz
Ausstechformen mit Auswerfer, 3 Stk
Emportes-pièces, 3 pcs
Cortadores, 3 pz

art.	Ø cm.
47622-04	3>4,5

Holly. – Agrifoglio.



Dough plunger cutters w/extractor, 4 pcs

Tagliapasta con espulsore, set 4 pz
Ausstechformen mit Auswerfer, 4 Stk
Emportes-pièces, 4 pcs
Cortadores, 4 pz

art.	Ø cm.
47622-26	1,2 - 2 - 2,8 - 3,5

Daisy. – Margherita.



Dough plunger cutters w/extractor, 3 pcs

Tagliapasta con espulsore, set 3 pz
Ausstechformen mit Auswerfer, 3 Stk
Emportes-pièces, 3 pcs
Cortadores, 3 pz

art. Ø cm.

47622-01 3x5

Petunie. – Petunia.



Dough plunger cutters w/extractor, 3 pcs

Tagliapasta con espulsore, set 3 pz
Ausstechformen mit Auswerfer, 3 Stk
Emportes-pièces, 3 pcs
Cortadores, 3 pz

art. Ø cm.

47622-02 2,5

Flower. – Fiore.



Dough plunger cutters w/extractor, 3 pcs

Tagliapasta con espulsore, set 3 pz
Ausstechformen mit Auswerfer, 3 Stk
Emportes-pièces, 3 pcs
Cortadores, 3 pz

art. Ø cm.

47622-03 3x5

Rose leaf. – Foglia di rosa.



SS

Set of 9 cutters

Set 9 tagliapasta
Satz 9 Ausstechformen
Set 9 découpoirs
Juego 9 cortadores

art. h. cm.

47837-09 0,5



PA

Almont past knife

Coltello per marzapane
Marzipan-Messer
Couteau à pâte d'amande
Cuchillo para fondant/mazapán

art. l. cm.

47630-28 16,5



PP

Marzipan set, 15 pcs

Set 15 pezzi per marzapane
Marzipan-Satz, 15 Stk.
Set 15 outils à pâte d'amandes
Set de 15 herramientas para decorar galletas

art.

47631-12



PP

Marzipan set, 8 pcs

Set 8 pezzi per marzapane
Marzipan-Satz, 8 Stk.
Set 8 outils à pâte d'amandes
Set de 8 herramientas para decorar galletas

art.

47631-08



SS

Set of 10 pcs dipping forks

Set 10 forchettine pralineria
Pralinen Gabelchen, 10 Stk.
Jeu de 10 ébauchoirs
Set de 10 herramientas para decorar chocolates

art.

47833-10



SS

Set of 4 pcs dipping forks

Set 4 forchettine pralineria
Pralinen Gabelchen, 4 Stk.
Jeu de 4 ébauchoirs
Set de 4 herramientas para decorar chocolates

art.

47833-04



SS

Set 2 decorating spoons

Set 2 cucchiari decorazione
Satz 2 Dekoration-Löffel
Set 2 cuillères pour décorer
2 cucharas para decoración

art. l. cm.

47831-02 19-23



STAINLESS STEEL NOZZLES
BOCCHETTE INOX



Set 12 pcs, one piece nozzles

Set 12 bocchette unipezzo
Tüllen Set 12 Stk. aus einem Stück gezogen
Set 12 pcs douilles monobloc
Surtido 12 boquillas monobloc

art.	Ø mm.	base ø mm.
47357-20	1x 0,6-1,2-1,5-1,9-2,4-3 3,6-4,8-5,6-6,4-6,8-7,6	18

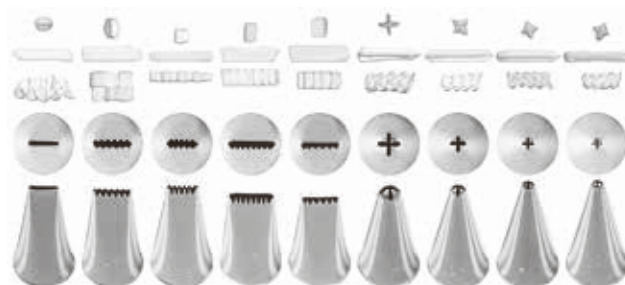

Set 9 pcs, one piece nozzles

Set 9 bocchette unipezzo
Tüllen Set 9 Stk. aus einem Stück gezogen
Set 9 pcs douilles monobloc
Surtido 9 boquillas monobloc

art.	base ø mm.
47357-24	18



Set 7 pcs, one piece nozzles

Set 7 bocchette unipezzo
Tüllen Set 7 Stk. aus einem Stück gezogen
Set 7 pcs douilles monobloc
Surtido 7 boquillas monobloc

art.	Ø mm.	base ø mm.
47357-21	1x 1,7-2,2-3,5-4,2-5,5-5,7	18



Set 8 pcs, one piece nozzles

Set 8 bocchette unipezzo
Tüllen Set 8 Stk. aus einem Stück gezogen
Set 8 pcs douilles monobloc
Surtido 8 boquillas monobloc

art.	Ø mm.	base ø mm.
47357-22	1x 1-1,5-1,8-2,6-3-3,4-2,5-7	18

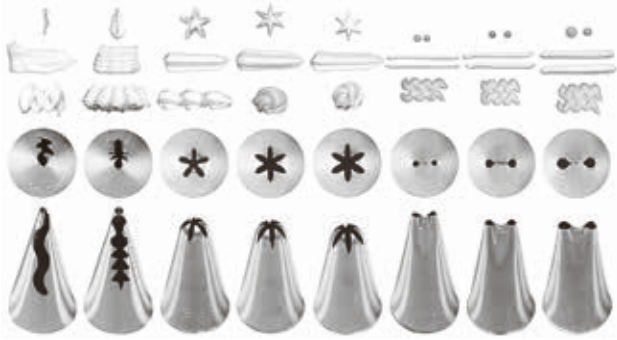

Set 8 pcs, one piece nozzles

Set 8 bocchette unipezzo
Tüllen Set 8 Stk. aus einem Stück gezogen
Set 8 pcs douilles monobloc
Surtido 8 boquillas monobloc

art. base ø mm.
47357-23 18



Set 8 pcs, one piece nozzles

Set 8 bocchette unipezzo
Tüllen Set 8 Stk. aus einem Stück gezogen
Set 8 pcs douilles monobloc
Surtido 8 boquillas monobloc

art. base ø mm.
47357-25 18



Set 8 pcs, one piece nozzles

Set 8 bocchette unipezzo
Tüllen Set 8 Stk. aus einem Stück gezogen
Set 8 pcs douilles monobloc
Surtido 8 boquillas monobloc

art. base ø mm.
47357-26 18



Set 8 pcs, one piece nozzles

Set 8 bocchette unipezzo
Tüllen Set 8 Stk. aus einem Stück gezogen
Set 8 pcs douilles monobloc
Surtido 8 boquillas monobloc

art. base ø mm.
47357-27 18



Set 8 pcs, one piece nozzles

Set 8 bocchette unipezzo
Tüllen Set 8 Stk. aus einem Stück gezogen
Set 8 pcs douilles monobloc
Surtido 8 boquillas monobloc

art. base ø mm.
47357-28 18



Set 8 pcs, one piece nozzles

Set 8 bocchette unipezzo
Tüllen Set 8 Stk. aus einem Stück gezogen
Set 8 pcs douilles monobloc
Surtido 8 boquillas monobloc

art. base ø mm.
47357-29 18



Set 8 pcs, one piece nozzles

Set 8 bocchette unipezzo

Tüllen Set 8 Stk. aus einem Stück gezogen

Set 8 pcs douilles monobloc

Surtido 8 boquillas monobloc

art. base ø mm.
 47357-30 18



Set 8 pcs, one piece nozzles

Set 8 bocchette unipezzo

Tüllen Set 8 Stk. aus einem Stück gezogen

Set 8 pcs douilles monobloc

Surtido 8 boquillas monobloc

art. base ø mm.
 47357-31 18



Set 6 pcs, one piece nozzles

Set 6 bocchette unipezzo

Tüllen Set 6 Stk. aus einem Stück gezogen

Set 6 pcs douilles monobloc

Surtido 6 boquillas monobloc

art. base ø mm.
 47357-06 25



Set 6 pcs, one piece nozzles

Set 6 bocchette unipezzo

Tüllen Set 6 Stk. aus einem Stück gezogen

Set 6 pcs douilles monobloc

Surtido 6 boquillas monobloc

art. base ø mm.
 47357-07 25



Set 6 pcs, one piece nozzles

Set 6 bocchette unipezzo

Tüllen Set 6 Stk. aus einem Stück gezogen

Set 6 pcs douilles monobloc

Surtido 6 boquillas monobloc

art. base ø mm.
 47357-08 25

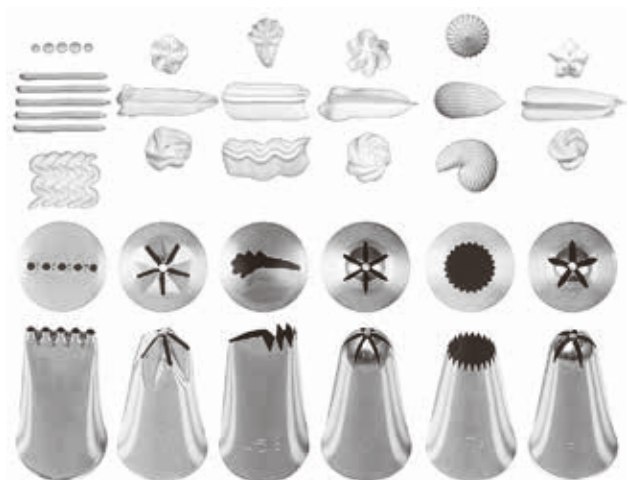

Set 6 pcs, one piece nozzles

Set 6 bocchette unipezzo

Tüllen Set 6 Stk. aus einem Stück gezogen

Set 6 pcs douilles monobloc

Surtido 6 boquillas monobloc

art. base ø mm.
 47357-09 25

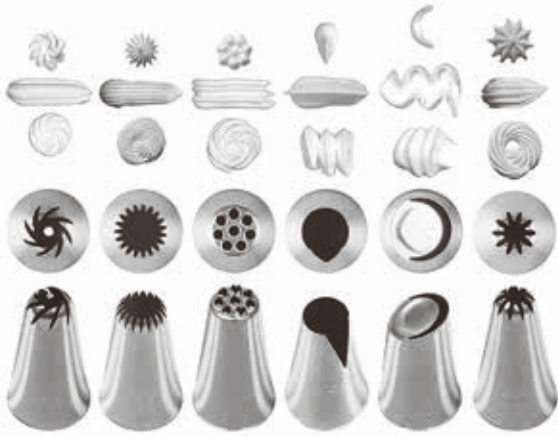

Set 6 pcs, one piece nozzles

Set 6 bocchette unipezzo

Tüllen Set 6 Stk. aus einem Stück gezogen

Set 6 pcs douilles monobloc

Surtido 6 boquillas monobloc

art. base ø mm.

47357-10 25



Set 6 pcs, one piece nozzles

Set 6 bocchette unipezzo

Tüllen Set 6 Stk. aus einem Stück gezogen

Set 6 pcs douilles monobloc

Surtido 6 boquillas monobloc

art. base ø mm.

47357-11 25



Set 4 pcs, one piece nozzles

Set 4 bocchette unipezzo

Tüllen Set 4 Stk. aus einem Stück gezogen

Set 4 pcs douilles monobloc

Surtido 4 boquillas monobloc

art. base ø mm.

47357-01 31



Set 4 pcs, one piece nozzles

Set 4 bocchette unipezzo

Tüllen Set 4 Stk. aus einem Stück gezogen

Set 4 pcs douilles monobloc

Surtido 4 boquillas monobloc

art. base ø mm.

47357-02 2x 31 - 2x 36



Set 7 pcs, one piece nozzles

Set 7 bocchette unipezzo

Tüllen Set 7 Stk. aus einem Stück gezogen

Set 7 pcs douilles monobloc

Surtido 7 boquillas monobloc

art. base ø mm.

47357-03 31



Set 3x2 nozzles

Set 3x2 bocchette

3x2 Stk. Tüllen

Set 3x2 pcs douilles

Juego 3x2 boquillas

art.	Ø mm.	stars
47350-01	2x 25	6
	2x 31	6
	2x 36	6



Set 3x2 nozzles

Set 3x2 bocchette

3x2 Stk. Tüllen

Set 3x2 pcs douilles

Juego 3x2 boquillas

art.	Ø mm.	stars
47351-01	2x 31	6
	2x 31	8
	2x 36	9



Set 3x2 nozzles

Set 3x2 bocchette

3x2 Stk. Tüllen

Set 3x2 pcs douilles

Juego 3x2 boquillas

art.	Ø mm.	stars
47352-01	2x 31	6
	2x 31	8
	2x 36	9



Set 6 pcs, one piece nozzles

Set 6 bocchette unipezzo

Tüllen Set 6 Stk. aus einem Stück gezogen

Set 6 pcs douilles monobloc

Surtido 6 boquillas monobloc

art.	Ø mm.	stars
47208-01	3,0	5
47208-02	3,0	6
47208-03	3,5	7
47208-04	5,0	8



Set 6 pcs, one piece nozzles

Set 6 bocchette unipezzo

Tüllen Set 6 Stk. aus einem Stück gezogen

Set 6 pcs douilles monobloc

Surtido 6 boquillas monobloc

art.	Ø mm.	stars
47208-05	5	5
47208-06	5	6
47208-07	6	7
47208-08	7	8



Set 6 pcs, one piece nozzles

Set 6 bocchette unipezzo

Tüllen Set 6 Stk. aus einem Stück gezogen

Set 6 pcs douilles monobloc

Surtido 6 boquillas monobloc

art.	Ø mm.	stars
47208-09	7	5
47208-10	7	6
47208-11	7	7
47208-12	9	8



Set 6 pcs, one piece nozzles

Set 6 bocchette unipezzo

Tüllen Set 6 Stk. aus einem Stück gezogen

Set 6 pcs douilles monobloc

Surtido 6 boquillas monobloc

art.	Ø mm.	stars
47208-13	11	5
47208-14	11	6
47208-15	11	7
47208-16	11	8



Set 6 pcs, one piece nozzles

Set 6 bocchette unipezzo

Tüllen Set 6 Stk. aus einem Stück gezogen

Set 6 pcs douilles monobloc

Surtido 6 boquillas monobloc

art.	Ø mm.	stars
47208-17	13	5
47208-18	13	6
47208-19	13	7
47208-20	13	8



Set 6 pcs, one piece nozzles

Set 6 bocchette unipezzo

Tüllen Set 6 Stk. aus einem Stück gezogen

Set 6 pcs douilles monobloc

Surtido 6 boquillas monobloc

art.	Ø mm.	stars
47208-21	18	5
47208-22	18	6
47208-23	18	7
47208-24	18	8



Set 6 pcs, one piece nozzles

Set 6 bocchette unipezzo

Tüllen Set 6 Stk. aus einem Stück gezogen

Set 6 pcs douilles monobloc

Surtido 6 boquillas monobloc

art.	Ø mm.	stars
47354-02	2	6
47354-04	4	6
47354-06	6	6
47354-08	8	6
47354-10	10	6
47354-12	12	7
47354-14	14	8
47354-16	16	9
47354-18	18	10



Set 6 pcs, one piece nozzles

Set 6 bocchette unipezzo

Tüllen Set 6 Stk. aus einem Stück gezogen

Set 6 pcs douilles monobloc

Surtido 6 boquillas monobloc

art.	Ø mm.	stars
47355-02	2,5	6
47355-04	4,0	6
47355-06	6,0	6
47355-08	8,0	7
47355-10	10,0	8
47355-12	12,0	10



Set 6 pcs, one piece nozzles

Set 6 bocchette unipezzo

Tüllen Set 6 Stk. aus einem Stück gezogen

Set 6 pcs douilles monobloc

Surtido 6 boquillas monobloc

art.	Ø mm.	stars
47356-02	2,0	5
47356-04	4,0	9
47356-06	5,5	9
47356-08	7,0	10
47356-10	8,5	12
47356-12	13,0	15
47356-14	14,5	16
47356-16	16,0	17
47356-18	17,5	18



Set 6 pcs, one piece nozzles

Set 6 bocchette unipezzo

Tüllen Set 6 Stk. aus einem Stück gezogen

Set 6 pcs douilles monobloc

Surtido 6 boquillas monobloc

art.	Ø mm.
47353-02	2
47353-04	4
47353-06	6
47353-08	8
47353-10	10
47353-12	12
47353-14	14
47353-16	16
47353-18	18
47353-20	20
47353-22	22
47353-24	24



Set 6 pcs, one piece nozzles

Set 6 bocchette unipezzo

Tüllen Set 6 Stk. aus einem Stück gezogen

Set 6 pcs douilles monobloc

Surtido 6 boquillas monobloc

art.	Ø mm.
47207-20	20
47207-25	25
47207-30	30



Set 10 pcs Bismark nozzles

Set 10 bocchette a imbuto

Fülltüllen Set 10 Stk.

Set 10 douilles à choux

Surtido 10 boquillas para relleno

art.	Ø mm.	l. mm.
47127-04	4	90
47127-06	6	75
47127-08	8	90



Nozzle
 Bocchetta decorativa
 Spritztülle
 Douille
 Boquilla

art.	Ø mm.	h. cm.
47357-50	55	6



Nozzle
 Bocchetta decorativa
 Spritztülle
 Douille
 Boquilla

art.	Ø mm.	h. cm.
47357-51	55	5,6



Nozzle
 Bocchetta decorativa
 Spritztülle
 Douille
 Boquilla

art.	Ø mm.	h. cm.
47357-40	32	6,0
47357-41	32	5,7
47357-42	32	5,7
47357-43	32	5,7
47357-44	32	5,7



PP

Set of 6 nozzles
 Set 6 bocchette
 Tüllen Set, 6 Stk
 Set 6 douilles
 Juego 6 boquillas

art.	Ø mm.
47214-86	5-7-9-11-13-15



PP

Set of 6 nozzles
 Set 6 bocchette
 Tüllen Set, 6 Stk
 Set 6 douilles
 Juego 6 boquillas

art.	Ø mm.
47215-86	3-5-7-9-11-13



PP

Set of 8 nozzles
 Set 8 bocchette
 Tüllen Set, 8 Stk
 Set 8 douilles
 Juego 8 boquillas

art.
47216-88



PP

Set of 12 nozzles
 Set 12 bocchette
 Tüllen Set, 12 Stk
 Set 12 douilles
 Juego 12 boquillas

art.	Ø mm.
47618-10	2>10
47618-20	10>20



PC

Set of 12 nozzles
 Set 12 bocchette
 Tüllen Set, 12 Stk
 Set 12 douilles
 Juego 12 boquillas

art.
47250-12

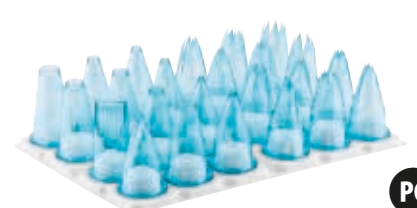

PC

Set of 24 nozzles
 Set 24 bocchette
 Tüllen Set, 24 Stk
 Set 24 douilles
 Juego 24 boquillas

art.
47250-24



Flower nozzles 12 pcs

Bocchette floreali 12 pz
Spritztüllen 12 Stk
Douille fleurs 12 pcs
Boquillas florales 12 pz

art.
47357-38



Set of 29 nozzles

Set 29 bocchette
Tüllen Set, 29 Stk
Set 29 douilles
Juego 29 boquillas

art.
47219-29

26 tubes, 2 flower nails, 1 standard coupler. – 26 bocchette, 2 chiodi per fiori, 1 adattatore standard.



Set of 38 nozzles

Set 38 bocchette
Tüllen Set, 38 Stk
Set 38 douilles
Juego 38 boquillas

art.
47219-38

35 tubes, 1 medium coupler, 1 large coupler. – 35 bocchette, 1 adattatore medio, 1 grande.



Set of 55 nozzles

Set 55 bocchette
Tüllen Set, 55 Stk
Set 55 douilles
Juego 55 boquillas

art.
47219-55

52 tubes, 2 flower nails, 1 standard coupler. – 52 bocchette, 2 chiodi per fiori, 1 adattatore standard.

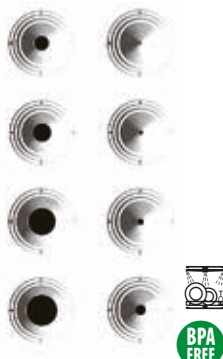

Set of 13 assorted nozzles

Set 13 bocchette assortite
Tüllensortiment, 13 Stk
Set 13 douilles assorties
Juego 13 boquillas

art.
47251-00

8 tubes mm. 1/2/3/5/7/9/13/15, 2 adapters, 2 lids, 1 brush. 8 bocchette mm. 1/2/3/5/7/9/13/15, 2 adattatori, 2 tappi, 1 bruschino.

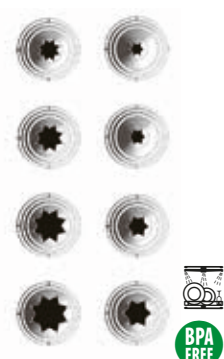

Set of 13 assorted nozzles

Set 13 bocchette assortite
Tüllensortiment, 13 Stk
Set 13 douilles assorties
Juego 13 boquillas

art.
47251-01

8 star tubes mm. 4/5/7/9 (6 points), 7/9/11/13 (8 points), 2 adapters, 2 lids, 1 brush. – 8 bocchette foro stella mm. 4/5/7/9 (6 punte), 7/9/11/13 (8 punte), 2 adattatori, 2 tappi, 1 bruschino.

PAstry PASTICCERIA
STAINLESS STEEL NOZZLES BOCCHETTE INOX



Set of 13 assorted nozzles

Set 13 bocchette assortite
Tüllensortiment, 13 Stk
Set 13 douilles assorties
Juego 13 boquillas

art.

47251-02

8 tubes, 1 bismark tube, 2 adapters, 2 lids.
8 bocchette, 1 bocchetta a imbuto, 2 adattatori, 2 tappi.



Set of 13 assorted nozzles

Set 13 bocchette assortite
Tüllensortiment, 13 Stk
Set 13 douilles assorties
Juego 13 boquillas

art.

47251-03

8 star tubes mm. 4,5/5,5/6/7,5/8/9/10, 2 adapters, 2 lids, 1 brush.
8 bocchette foro stella mm. 4,5/5,5/6/7,5/8/9/10, 2 adattatori, 2 tappi, 1 bruschino.



External piping tip adapter

Adattatore per bocchette
Adapter für Spritztüllen
Adaptateur à douilles
Adaptador para boquillas

art.	Ø mm.	des.
47212-01	18	STANDARD



External piping tip adapter

Adattatore per bocchette
Adapter für Spritztüllen
Adaptateur à douilles
Adaptador para boquillas

art.	Ø mm.	des.
47212-02	25-31	MEDIUM



External piping tip adapter

Adattatore per bocchette
Adapter für Spritztüllen
Adaptateur à douilles
Adaptador para boquillas

art.	Ø mm.	des.
47212-03	36	LARGE



Nozzles adapter, 2 pcs

Adattatori per bocchette, 2 pz
Spritztüllen-Adapter, 2 Stk
Adaptateurs à douilles, 2 pièces
Adaptadores boquillas, 2 piezas

art.

47212-05

To prepare decorations with 2 or 3 colours.
Suitable for piping tips Ø30 h 50 mm.
Per decorazioni a 2 o 3 colori. Adatte a bocchette Ø30 h 50 mm.



Pastry tube brush, 6 pcs

Bruschino per bocchette, 6 pz
Tüllen-Bürste, 6 Stk
Brosse à douilles, 6 pcs
Cepillo para boquillas, 6 pz

art.	Ø cm.	l. cm.
47200-01	0,8	10,0
47200-02	0,5-2,4	12,5



Cream roll molds, 10 pcs

Cannoli, 10 pz
Sahnerolle, konisch/gerade, 10 Stk
Rouleau à fromage, 10 pcs
Rodillos queso, 10 pz

art.	Ø mm.	l. mm.
47020-15	15	92
47020-20	22	142
47020-30	10-25	139
47020-35	20-25	171



Cream horn molds, 10 pcs

Cornetti, 10 pz
Schillerlockenform, 10 Stk
Moulet à cornet, 10 pcs
Moldes para conos, 10 pz

art.	Ø mm.	l. mm.
47021-35	34	110
47021-45	47	161



Cream horn molds, 10 pcs

Cornetti, 10 pz
Schillerlockenform, 10 Stk
Moulet à cornet, 10 pcs
Moldes para conos, 10 pz

art.	cm.
47021-30	3x12



PA



Decorating set 8 pcs

Kit decoro 8 pezzi
Dekorations-Set, 8-teilig
Set 8 pcs à décorer
Juego 8 piezas para decorar

art.
47120-01

6 small tubes, 1 standard coupler, 1 bag cm. 35
6 bocchette piccole, 1 adattatore standard, 1 sacchetto 35 cm.



Decorating set 8 pcs

Kit decoro 8 pezzi
Dekorations-Set, 8-teilig
Set 8 pcs à décorer
Juego 8 piezas para decorar

art.
47120-02

6 medium tubes, 1 medium coupler, 1 bag cm. 40.
6 bocchette medie, 1 adattatore medio, 1 sacchetto 40 cm.



Icing bag

Sacchetto per decorare
Spritzbeutel
Sac à dresser
Mangas para decorar

art.	h. cm.	U. Pack
47106-28	28	6
47106-34	34	6
47106-40	40	6
47106-46	46	6
47106-50	50	6

Synthetic fibre with multi-layer water-proof plastic coating.



Icing bag

Sacchetto per decorare
Spritzbeutel
Sac à dresser
Mangas para decorar

art.	h. cm.	U. Pack
47106-55	55	6
47106-60	60	6
47106-65	65	6
47106-70	70	6
47106-75	75	6

Fibra sintetica con rivestimento a strati in plastica impermeabile.



Icing bag

Sacchetto per decorare
Spritzbeutel
Sac à dresser
Mangas para decorar

art.	h. cm.	U. Pack
47105-28	28	6
47105-34	34	6
47105-40	40	6
47105-46	46	6
47105-50	50	6

With reinforced tip, seam and hanger. Cotton with multi-layer water-proof plastic coating.



Icing bag

Sacchetto per decorare
Spritzbeutel
Sac à dresser
Mangas para decorar

art.	h. cm.	U. Pack
47105-55	55	6
47105-60	60	6
47105-65	65	6
47105-70	70	6
47105-75	75	6

Con punta rinforzata, orlo e gancio. Cotone con rivestimento a strati in plastica impermeabile.



Icing bag

Sacchetto per decorare
Spritzbeutel
Sac à dresser
Mangas para decorar

art.	h. cm.	U. Pack
47119-30	30	6
47119-35	35	6
47119-40	40	6
47119-45	45	6
47119-50	50	6
47119-60	60	6

With reinforced tip, seam and hanger. Polyurethan with nylon coating. High frequency electric seaming. – Con punta rinforzata, orlo e gancio. Poliuretano con rivestimento in nylon. Saldatura ad alta frequenza.



PE

Disposable icing bag

Sacchetto per decorare, monouso
Einwegspritzbeutel
Sac à dresser jetable
Mangas desechables

art.	my	h. cm.	pcs/pz
47118-30	80	30	100
47118-40	80	40	100
47118-55	80	55	100
47118-65	80	65	100



PE

Disposable icing bag

Sacchetto per decorare, monouso
Einwegspritzbeutel
Sac à dresser jetable
Mangas desechables

art.	my	h. cm.	pcs/pz
47111-30	90	30	100
47111-40	90	40	100
47111-46	90	46	100
47111-55	90	55	100



PE

Double pastry bag

Sacchetto per decorare doppio
Doppeldressierbeutel
Sac à dresser, double
Mangas para decorar, doble

art.	my	cm.	pcs/pz
47104-45	70	45,5x30,5	75

Disposable. For 2 ingredients. Closed tip, can be used without tube.

Monouso. Per 2 ingredienti. Punta chiusa, può essere utilizzato senza bocchette.



Icing bag, polyurethane

Sacchetto per decorare, poliuretano
Spritzbeutel, Polyurethan
Sac à dresser, polyuréthane
Mangas para decorar, poliuretano

art.	h. cm.
47112-34	34
47112-45	45
47112-50	50



BPA FREE

PP

Bag clip

Clip chiudi sacco
Verschluss-Clip
Clip ferme sachet
Pinza cierra bolsas

art.	l. cm.	pcs/pz
42908-14	14	3
42908-24	21	1

Freezer, dishwasher and microwave safe. Safe to use with food. – Idonei ad uso in freezer, lavastoviglie e microonde. Per alimenti.



SS

Cookie press and icing set 20 pcs

Siringa per pasticceria, set 20 pezzi
Gebäckspritze-Satz, 20 Stk.
Seringue à biscuits, jeu 20 pcs
Juego pistola repostería, juego 20 pcs.

art.	ml.
47010-20	250

For a correct use of the syringe we suggest shortbread dough. – Per un utilizzo ottimale della siringa suggeriamo la frolla montata.

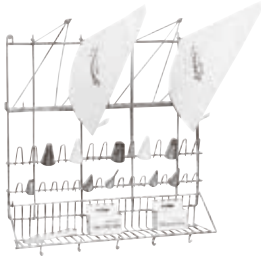

SS

Icing bags & nozzles wall rack
Espositore sacchetti/bocchette
Spritzbeutel-/ u. Tüllenaufhänger
Séchoir à poche et douilles
Secador mangas y boquillas

art. dim. cm.
47113-03 50x42x50



SS

Wall rack for icing bags
Espositore per sacchetti
Spritzbeutelaufräger
Séchoir à poche
Secador cuelga-mangas

art. dim. cm.
47107-00 50x42x26

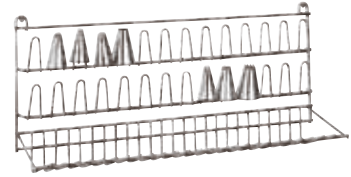

SS

Wall rack for nozzles
Espositore per bocchette
Tüllenaufhänger
Séchoir à douilles
Secador boquillas

art. dim. cm.
47108-00 50x13x24



PP

Icing bag holder
Vaso porta sacchetto
Spritzbeutel-Absetzständer
Support à poches
Soporte para mangas

art. Ø cm. h. cm.
47110-23 19,5 23



Cake plate, swivel base, aluminum
Girello, alluminio
Tortendrehscheibe, aluminium
Guéridon plaque tournante, alu
Pedestal giratorio para tartas, aluminio

art. Ø cm. h. cm.
47101-30 30 10



Cake plate, swivel base, aluminum
Girello, alluminio
Tortendrehscheibe, aluminium
Guéridon plaque tournante, alu
Pedestal giratorio para tartas, aluminio

art. dim. cm.
47101-40 30x40x10



MF

Cake-plate, swivel base
Girello per decorazione torte
Tortendrehscheibe
Guéridon plaque tournante
Pedestal giratorio para tartas

art. Ø cm. h. cm.
47103-32 32 10



PE

Protection cover
Campana
Abdeckhauben
Cloche
Tapa

art. Ø cm. h. cm.
47103-30 30 12



SS

Cake peel
Pala per torte
Tortenschaukel
Pelle à tarte
Pala para tartas

art. Ø cm.
47094-30 30



Doilies
Pizzi sottotorta
Tortenspitzen, Rosendekor
Dentelles décor rose
Blondas

art. dim. cm. pcs/pz
47687-24 18-25 250



Doilies
Pizzi sottotorta
Tortenspitzen, Rosendekor
Dentelles décor rose
Blondas

art. dim. cm. pcs/pz
47686-10 6-10 250
47686-12 6,5-12 250
47686-14 8-14 250
47686-17 9,5-16,5 250
47686-22 12,5-22 100
47686-24 15-24 100



Doilies
Pizzi sottotorta
Tortenspitzen, Rosendekor
Dentelles décor rose
Blondas

art. dim. cm. pcs/pz
47686-26 16-27 100
47686-30 19-30 100
47686-33 20-32 100
47686-36 32-36 100
47686-42 25-42 100

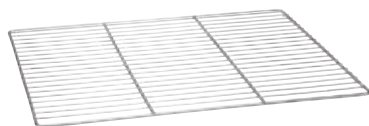

SS

Draining rack
Griglia di collaggio
Überziehgitter
Grille à glacer
Rejilla

art.	dim. cm.
44430-60	60x40

Frame ø mm 5, 2 cross-bars, 29 wires ø 2 mm.
Quadro ø mm 5, 2 traverse, 29 fili ø 2 mm.

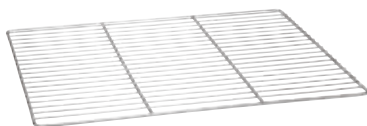

SS

Draining rack
Griglia di collaggio
Überziehgitter
Grille à glacer
Rejilla

art.	dim. cm.
44430-61	60x40

Frame ø mm 6, 2 cross-bars, 24 wires ø 3 mm.
Quadro ø mm 6, 2traverse, 24 fili ø 3 mm.



SS

Draining rack
Griglia di collaggio
Überziehgitter
Grille à glacer
Rejilla

art.	dim. cm.
44431-46	46x30,5x2,5
44431-60	60x40x2,5

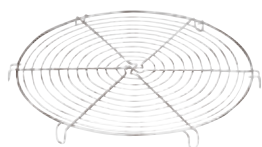

Cake cooling tray, chromed
Griglia di raffreddamento, cromata
Tortengitter, verchromt
Grille ronde à tourte, chromé
Rejilla para tortas, cromada

art.	Ø cm.
47098-18	18,5
47098-22	22,0
47098-26	26,0
47098-30	30,0



Baking tray, aluminum
Teglia, alluminio
Backblech, Aluminium
Plaque à cuisson, aluminium
Placa pastelería, aluminio

art.	GN	dim. cm.
41744-32	1/1	32,5x53x1
41744-53	2/1	53x65x1
41744-60	-	60x40x1



Baking tray, perforated, aluminum
Teglia forata, alluminio
Backblech, Aluminium, gelocht
Plaque perforée, aluminium
Placa pastelería perforada, aluminio

art.	GN	dim. cm.
41756-30	-	30x40x1
41756-32	1/1	32,5x53x1
41756-53	2/1	53x65x1
41756-60	-	60x40x1



Baking tray, alusteel
Teglia rettangolare, alluminata
Backblech mit Aluminiumüberzug
Plaque, tôle aluminitée
Placa pastelería, aluminizada

art.	dim. cm.
41746-60	60x40x2



Baking tray, alusteel
Teglia rettangolare, alluminata
Backblech mit Aluminiumüberzug
Plaque, tôle aluminitée
Placa pastelería, aluminizada

art.	dim. cm.
41751-30	30x23x3
41751-35	35x28x3
41751-40	40x30x3
41751-50	50x35x3
41751-60	60x40x3
41751-65	65x45x3



Baking tray, non stick coated
Teglia rettangolare, antiaderente
Backblech mit Antihafbeschichtung
Plaque revêtement anti-adhésif
Placa pastelería anti-adherente

art.	dim. cm.
41747-60	60x40x2



Baking tray, silicone coated
Teglia, siliconata
Backblech, Silikonbeschichtet
Plaque, revêtement silicone
Placa pastelería siliconada

art.	GN	dim. cm.
41743-32	1/1	32,5x53x1
41743-53	2/1	53x65x1
41743-60	-	60x40x1



Baking tray, perforated, silicone coated
Teglia forata, siliconata
Backblech, gelocht, Silikonbeschichtet
Plaque perforée, revêtement silicone
Placa perforada siliconada

art.	GN	dim. cm.
41753-30	-	30x40x1
41753-32	1/1	32,5x53x1
41753-53	2/1	53x65x1
41753-60	-	60x40x1



Bread mold, blue steel

Bacinella carré, ferro blu
Brotform, Blaublech
Pain de mie, tôle bleuie
Molde, hierro

art.	dim. cm.
41748-20	20x10x10
41748-30	30x10x10
41748-35	35x10x10
41748-40	40x10x10
41748-50	50x10x10



Bread mold, alusteel

Bacinella carré, alluminata
Brotform mit Aluminiumüberzug
Pain de mie, tôle aluminitée
Molde, acero aluminizado

art.	dim. cm.
41750-20	20x10x10
41750-30	30x10x10
41750-40	40x10x10
41750-41	40x15x15
41750-50	50x10x10



SS

Confectionery funnel

Imbuto colatore
Likör- u. Fondanttrichter
Entonnoir à fondant
Embudo colador

art.	Ø cm.	h. cm.	lt.
47800-22	22	21	2

Supplied with 3 nozzles ø 2, 4, 6 mm.
Con 3 bocchette ø 2, 4, 6 mm.



PC

Confectionery funnel

Imbuto colatore
Likör- u. Fondanttrichter
Entonnoir à fondant
Embudo colador

art.	Ø cm.	h. cm.	lt.
47801-20	14	20	0,9

Supplied with 3 nozzles ø 4, 6, 7,5 mm.
Con 3 bocchette ø 4, 6, 7,5 mm.



SS

Cream dispenser

Dosa creme
Dosierer
Doseur à crème
Dosificador

art.	dim. cm.
47612-01	20x16x23



Cream injector, cast aluminum

Dosatrice per creme, alluminio pressofuso
Gebäkfüllmaschine
Entonnoir à crème
Dosificador de porciones

art.	dim. cm.	lt.
47694-03	44x25	3

Funnel, cylinder, piston, injector, lever and thrust rib in s/s. Piston: ø 24 mm. Doses: 1-12 gr.
Imbuto, cilindro, pistone, iniettore, leva e nasello di spinta in acciaio inox. Pistone: ø 24 mm. Dosi: 1-12 gr.



Caramelizing rod

Caramellizzatore
Caramelisier-Eisen
Fer à caraméliser
Quemador

art.	Ø cm.
47846-10	10,5



Electric caramelizing rod

Caramellizzatore elettrico
Caramelisier-Eisen, elektrisch
Fer à caraméliser électrique
Quemador eléctrico

art.	Ø cm.	kW
47847-10	10	0,65
47847-12	12	1,00



Electric caramelizing rod

Caramellizzatore elettrico
Caramelisier-Eisen, elektrisch
Fer à caraméliser électrique
Quemador eléctrico

art.	l. cm.	kW
47847-23	23	1,5



Electric spray gun

Pistola elettrica
Sprühpistole, elektrisch
Pistolet électrique
Pistola eléctrica

art.	ml.	W
47848-07	700	60

Bar 0-160, rpm 250 - For butter, oil, fat, wax, jelly, jam, chocolate, releasing agents and emulsions. Usable for hot liquids max. 65 °C. Nozzle 0,6 mm. – Per burro, oli, cera, gelatina, marmellata, cioccolata, antiagglomeranti ed emulsionanti. Per liquidi caldi max. 65°C. Bocchetta 0,6 mm.



Airbrush compressor

Compressore per penna aerografa
Airbrush Kompressor
Compresseur
Compresor

art.	dim. cm.	kW
47844-06	16x30x23	0,2

Bar 4.



Airbrush, double action

Penna aerografa, doppia azione
Airbrush-Pistole, Doppelaktion
Aérographe, dual action
Equipo aerógrafo, doble acción

art.	Ø mm.	cap.
47844-02	0,3	7 cm3



Airbrush stand

Supporto penna aerografa
Airbrush-Pistole Gestell
Support aérographe
Soporte aerógrafo

art.
47844-01



SS

Sugar lamp

Lampada per zucchero
Zuckerlampe
Lampe à sucre
Lámpara para azúcar

art.	dim. cm.
47840-11	61x41x50

Infrared lamp, 3 selection powers 500-1000-1500W. Cable included. – Lampada infrarossi con 3 potenze selezionabili, 500-1000-1500W. Incl. cavo di alimentazione.



SS

Tempering unit

Temperatrice
Temperierungsmaschine
Tempereuse
Unidad temperator

art.	dim. cm.	lt.
47698-03	40x24x13,5	3,6
47698-06	40x33x13,5	6,0

Dry heat analogue melters. Manual thermostat. UK / US / JAPAN / AUSTRALIA / CHINA wirings available upon request. – Scioglitori a secco analogici. Termostato manuale. Su richiesta disponibili scioglitori con cablaggio GB / USA / GIAPPONE / AUSTRALIA / CINA.



Chef's torch

Cannello professionale
Profí-Wärmepistole
Chalumeau de cuisine
Soplete cocina

art.	dim. cm.	ml.
47841-03	8x7x16	200
47841-04	12x7x18	280



Sugar bulb

Pompetta con terminale in rame
Blaszuckerspritze
Poire à sucre soufflé
Pera para azúcar soplado

art. 47838-00



SS

Sugar thermometer

Termometro per zucchero
Zuckerthermometer
Thermomètre à sucre
Termometro para azúcar

art. 47843-00 scala 1°C +80+200 °C



SS

Sugar thermometer holder

Reggi caramellometro
Zuckerthermometer-Träger
Support pour thermomètre à sucre
Soporte para termometro azúcar

art. 47842-00 h. cm. 32



Syrup density meter test tube

Provetta alimentare graduata, plastica
Sirup-Hydrometer-Becher
Eprouvette pèse-sirop
Probeta aerómetro

art. 49703-01 Ø cm. 3 h. cm. 25 ml. 100

Can be sterilized up to 120°C.
Sterilizzabile fino a 120°C.



Syrup density meter

Pesa sciroppo (densimetro)
Sirup-Hydrometer
Pèse-sirop
Aerómetro

art. 49703-00 l. cm. 12,5

Temp.: 20°C - gr./ml./°Bé: 1.100/1.400/15-40 - Div.: 0,010 g/ml/2°Bé



PA+
plus

Angular spatula

Spatola angolare
Winkelpalette
Spatule angulaire
Espátula angular

art. 12909-12 l. cm. 12
12909-23 23



ABS

Smoother

Stendipasta
Teig-Glätter
Lisse-pâte
Espátula para alisar

art. 47627-01 dim. cm. 16x8



Biscuit spatula

Spatola per biscuit
Biscuit-Spachtel
Spatule à biscuit
Espátula para biscuit

art. 47626-55 l. cm. 55,5



Ruler

Riga
Lineal
Règle
Regla

art. 47033-50 l. cm. 60

5 divisions cm 12 and 7 divisions cm 8.
5 divisioni 12 cm e 7 da 8 cm.



Cake slicer

Lira per pan di Spagna
Tortendrahtschneider
Lyre à genoise
Cortador de pasteles

art. 47031-44 Ø cm. 30 h. cm. 20>90



Cake slicer, 3 cutting wires

Lira per pan di Spagna, 3 fili
Tortendrahtschneider, 3 Drähte
Lyre à genoise, 3 lames
Cortador de pasteles 3 alambres

art. 47031-46 Ø cm. 46 h. cm. 10>90





Mini guitar

Chitarra mini, 12
Praliné-Schneideapparat
Appareil à couper les pralinés
Cortador para pasteles

art. dim. cm.

47692-03 24x24

Includes a 22 mm frame and s/steel plate, 1 plastic spatula and accessories for maintenance. Do not use for frozen pies, chocolate bars or generally hard paste. – Include un telaio da 22 mm e piatto inox, 1 spatola plastica, accessori per la manutenzione. Non usare per torte congelate, tavolette di cioccolato, impasti duri in genere.

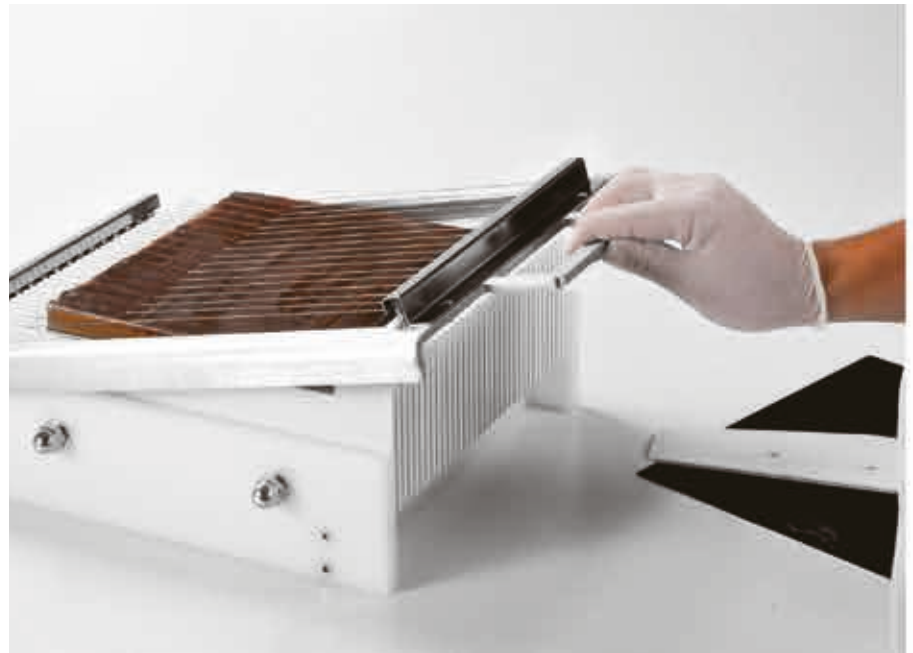

Base for ganache and 4 frames

Base per ganache + 4 telai
Basis und 4 Rahmen für Ganache
Base et 4 cadres à ganache
Base y 4 cuadros para ganache

art. dim. cm.

47693-00 39x45x13

Includes 2 frames 3 mm, 2 frames 5 mm, 1 spatula and Teflon base. Ganache's size 24x24 cm. – Include 2 telai 3 mm, 2 telai 5 mm, 1 spatola e base in teflon. Misura ganache 24x24 cm.



SS

Frames

Quadri per ganache
Rahmen
Cadres
Cuadros

art. dim. cm. int. cm.

47693-03 40x40x0,3 36x36

47693-05 40x40x0,5 36x36

47693-10 40x40x1,0 36x36

47693-15 40x40x1,5 36x36



Guitar

Chitarra
Praliné-Schneideapparat
Appareil à couper les pralinés
Cortador para pasteles

art. dim. cm.

47692-01 39x45x13

PST plastic base, 3 stainless steel cutting frames of 22,5 - 30 and 45 mm. Including 1 s/s sheet, plastic spatula, 3 spare wires, 2 wires fixing spanners. Base in PST, 4 telai inox da 22,5 - 30 e 45 mm. Inclusi 1 piatto inox, racla in PST, 3 fili di ricambio, 2 chiavi per fissaggio dei fili.



Double guitar

Chitarra doppia
Praliné-Schneideapparat
Appareil à couper les pralinés
Cortador para pasteles

art. dim. cm.

47692-02 39x45x13

PST base, 4 stainless steel cutting frames of 22,5 - 30 - 45 mm. and fixed side cutting frame 30 mm. Including 1 s/s sheet, plastic spatula, 3 spare wires, 2 wires fixing spanners.

Base in PST, 4 telai inox da 22,5 - 30 - 45 e laterale fisso da 30 mm. Inclusi 1 piatto inox, racla in PST, 3 fili di ricambio, 2 chiavi per fissaggio dei fili.



SS

Expanding pastry cutter

Tagliapasta estensibile

Teigschneider

Rouleau extensible

Cortapastas extensible

art.	Ø cm.	l. cm.
47820-05	5,5	24
47820-07	5,5	24



SS

Expanding pastry cutter

Tagliapasta estensibile

Teigschneider

Rouleau extensible

Cortapastas extensible

art.	Ø cm.
47830-05	9,5
47830-07	9,5



SS

Expanding pastry cutter

Tagliapasta estensibile

Teigschneider

Rouleau extensible

Cortapastas extensible

art.	Ø cm.	l. cm.
47821-05	5,5	24
47821-07	5,5	24



SS

Expanding pastry cutter

Tagliapasta estensibile

Teigschneider

Rouleau extensible

Cortapastas extensible

art.	Ø cm.	l. cm.
47822-05	5,5	28
47822-07	5,5	28



SS

Pastry wheel, plain

Rotella taglia pasta liscia

Teigrädchen, glatt

Roulette à pâte lisse

Ruleta cortapasta

art.	Ø cm.	l. cm.
18325-01	5,5	18



SS

Pastry wheel, fluted

Rotella taglia pasta ondulata

Teigrädchen, gewellt

Roulette à pâte cannelée

Ruleta cortapasta acanalada

art.	Ø cm.	l. cm.
18325-02	5,5	18



SS

Double pastry wheel

Rotella taglia pasta lama doppia

Teigrädchen, glatt u. gewellt

Roulette à pâte double

Ruleta cortapasta doble

art.	Ø cm.	l. cm.
18325-03	5,5	18



Cutting roller, POM

Rullo tagliapasta, POM

Rollmesser, POM

Rouleau à lamelles, POM

Rodillo, POM

art.	cm.
47026-06	6



Spiked roller, POM

Rullo bucasfoglia, POM

Stipprolle, POM

Pique-pâte, POM

Rodillo, POM

art.	cm.
47024-06	6,0
47024-10	11,5



Cutting roller, POM

Rullo per losanghe, POM

Rollmesser, POM

Rouleau à losanges, POM

Rodillo a rombos, POM

art.	cm.
47025-06	6,0
47025-10	11,5



SS

Spiked roller

Rullo bucasfoglia

Stipprolle

Pique-pâte

Rodillo

art.	cm.
47028-12	12



SS

Cutting roller

Rullo per losanghe

Rollmesser

Rouleau à losanges

Rodillo a rombos

art.	cm.
47029-12	12



PP
SS

Croissant cutter
Taglia croissants
Dreieckschneidewalze
Coupe-croissants
Cortador para croissants

art.	dim. cm.
47027-11	18x20
47027-12	18x14
47027-13	11x15
47027-14	9,7x21
47027-15	18x20 2x
47027-16	18x20 3x



PS

Stencil for grating pastry
Stampo decora crostate
Gitterstempel
Empreinte pour grille de pâte
Molde tortas

art.	Ø cm.
47030-30	30



PP

Cake marker
Segnaporzioni
Tortenteiler
Diviseur à tarte
Marcador de tartas

art.	Ø cm.	por.
47032-10	26,5	10
47032-20	26,5	20



PP

Cake marker, double-sided
Segnaporzioni, doppio
Tortenteiler, doppelseitig
Diviseur à tarte, double
Marcador de tartas, doble

art.	Ø cm.	por.
47033-08	18,0	8-12
47033-12	26,5	12-18
47033-14	26,5	14-18



Rolling pin, non-stick coated
Rullo antiaderente
Rollwalze mit Antihafbeschichtung
Rouleau avec revêtement anti-adhésif
Rodillo amasador anti-adherente

art.	Ø cm.	l. cm.
47035-40	5,5	20
47035-48	6,5	25



W

Rolling pin
Rullo
Rollwalze
Rouleau
Rodillo amasador

art.	Ø cm.	l. cm.
47036-30	9	30
47036-35	9	35
47036-40	9	40
47036-45	9	45
47036-50	9	50
47036-60	9	60



W

Rolling pin
Rullo
Rollwalze
Rouleau
Rodillo amasador

art.	Ø cm.	l. cm.
47038-50	9	50
47038-60	7	60



PE

Rolling pin
Rullo
Rollwalze
Rouleau
Rodillo amasador

art.	Ø cm.	l. cm.
47037-30	8,0	30
47037-40	7,5	40



PE

Rolling pin
Rullo
Rollwalze
Rouleau
Rodillo amasador

art.	Ø cm.	l. cm.
47034-23	2,5	23
47034-51	5,0	50



W

Rolling pin
Rullo
Rollwalze
Rouleau
Rodillo amasador

art.	Ø cm.	l. cm.
47034-52	5	50



SS

Rolling pin
Rullo
Rollwalze
Rouleau
Rodillo amasador

art.	Ø cm.	l. cm.
47034-50	5	50



PE

Rolling dough cutter

Rullo tagliapasta
Rollholzer
Rouleau coupe-bandes
Rodillo cortador

art.	l. cm.	cut mm.
47039-05	19	5
47039-10	19	10



PE

Rolling dough cutter

Rullo tagliapasta
Rollholzer
Rouleau coupe-bandes
Rodillo cortador

art.	l. cm.	cut mm.
47039-15	19	15



Pastry brush non-stick coated bristles

Pennello setole antiaderenti
Pinsel, antihftbeschichtete Borsten
Pinceau poils anti-adhérentes
Pincel cerdas antiadherentes

art.	cm.	U. Pack
47640-25	2,5	1
47640-35	3,5	1

Nylon bristles. Heat resistant up to +150°C.
Setole nylon. Resistente al calore fino a +150°C.



Pastry brush

Pennello per alimenti
Kuchenpinsel
Pinceaux à pâtissier
Pincel de cocina

art.	cm.	U. Pack
47642-30	3	6
47642-40	4	6
47642-50	5	6
47642-60	6	6
47642-70	7	6

Plastic handle, stainless steel ferrule.
Manico plastica, ghiera inox.



Pastry brush

Pennello per alimenti
Kuchenpinsel
Pinceaux à pâtissier
Pincel de cocina

art.	cm.	U. Pack
47643-30	3	6
47643-40	4	6
47643-50	5	6
47643-60	6	6
47643-70	7	6

Plastic handle, stainless steel ferrule.
Manico plastica, ghiera inox.



Pastry brush

Pennello per alimenti
Kuchenpinsel
Pinceaux à pâtissier
Pincel de cocina

art.	Ø cm.	U. Pack
47644-15	1,5	6

Plastic handle and ferrule.
Manico e ghiera plastica.



PA

Pastry brush

Pennello per alimenti
Kuchenpinsel
Pinceaux à pâtissier
Pincel de cocina

art.	cm.	U. Pack
47645-40	4,0	6
47645-60	6,0	6
47645-75	7,5	6

Natural bristles. – Setole naturali.



PA

Pastry brush

Pennello per alimenti
Kuchenpinsel
Pinceaux à pâtissier
Pincel de cocina

art.	cm.	U. Pack
47646-40	4,0	6
47646-60	6,0	6
47646-75	7,5	6

Polyester bristles. – Setole in poliestere.



PP

Set 10 dough scrapers

Set 10 raschietti
Teigschaber, 10 Stk.
Set 10 raclettes
Conjunto 10 rasquetas

art.	dim. mm.
47621-01	216x128



PP

Set 10 dough scrapers

Set 10 raschietti
Teigschaber, 10 Stk.
Set 10 raclettes
Conjunto 10 rasquetas

art.	dim. mm.
47621-02	120x86



PP

Set 10 dough scrapers

Set 10 raschietti
Teigschaber, 10 Stk.
Set 10 raclettes
Conjunto 10 rasquetas

art.	dim. mm.
47621-03	120x88



PP

Set 10 dough scrapers

Set 10 raschietti
Teigschaber, 10 Stk.
Set 10 raclettes
Conjunto 10 rasquetas

art.	dim. mm.
47621-04	121x81



PP

Set 10 dough scrapers

Set 10 raschietti
Teigschaber, 10 Stk.
Set 10 raclettes
Conjunto 10 rasquetas

art.	dim. mm.
47621-05	148x99



PP

Set 10 decorating combs

Set 10 pettini decoratori
Dekorationskamm, 10 Stk
Set 10 peignes à decor
Conjunto 10 peines decoradores

art.	dim. mm.
47621-06	145x99



PP

Set 10 decorating combs

Set 10 pettini decoratori
Dekorationskamm, 10 Stk
Set 10 peignes à decor
Conjunto 10 peines decoradores

art.	dim. mm.
47621-07	110x80



PP

Set 10 decorating combs

Set 10 pettini decoratori
Dekorationskamm, 10 Stk
Set 10 peignes à decor
Conjunto 10 peines decoradores

art.	dim. mm.
47621-08	216x128



SS

Set 3 decorating combs

Set 3 pettini decoratori
Dekorationskamm, 3 Stk
Set 3 peignes à decor
Conjunto 3 peines decoradores

art.	dim. mm.
47625-03	100x100



SS

Sugar dredger

Spargi zucchero
Zuckerstreuer
Glacière à sucre
Dosificador para azúcar

art.	Ø cm.	h. cm.
47022-12	7	9



Bottle for rum spraying

Bottiglia per bagne
Flasche zum Anfeuchten
Bouteille à puncher
Botella para bañar

art.	dim. cm.	lt.
47679-10	10x5,6x27,5	1



SS

Flour sifter

Setaccio farina
Einhand-Drücksieb
Tamiseur farine
Tamiz para harina

art.	Ø cm.	gr.
42607-05	12	500



Icing sugar sieve

Setaccio per zucchero a velo
Sieb für Puderzucker
Tamis à sucre glace
Cedazo para azúcar glas

art.	Ø cm.	h. cm.
47614-25	25,5	7



Sieve for flour

Setaccio rete farina
Sieb für Mehl
Tamis pour farine
Cedazo para harina

art.	Ø cm.	h. cm.
47615-25	25,5	7



Flour brush

Spazzola per farina
Mehlbürste
Brosse à pétrin
Cepillo para harina

art.	cm.
42614-21	30

Horse hair. – Setole di cavallo.



SS

Display tray

Vassoio espositore
Auslegeplatte
Plat patissier
Bandeja pastelería

art.	dim. cm.
47075-20	20x16x1
47075-30	30x21x1
47075-45	45x34x1



SS

Display tray

Vassoio espositore
Auslegeplatte
Plat patissier
Bandeja pastelería

art.	dim. cm.
42533-23	23x16,5x0,5
42533-26	26x19,5x0,5
42533-31	31x24x0,5
42533-36	36x28,5x0,5
42533-40	40x32,5x0,5



Display tray, aluminum

Vassoio espositore, alluminio
Auslegeplatte, Aluminium
Plat patissier, alu
Bandeja pastelería, aluminio

art.	dim. cm.
47070-37	37,5x24,5x1
47070-48	48x31x1
47070-60	60x40x1



Baking paper, siliconized

Carta da forno siliconata
Bactrennfolie, silikonisiert
Feuille de cuisson, siliconée
Papel de horno siliconado

art.	dim. cm.	pcs/pz
47682-53	53x32,5	500
47682-60	60x40	500

Artificial parchment, bleached, g/m²: 41,0, both sides siliconized, reusable, for all kinds of dough.
Pergamena artificiale, sbiancata, g/m²: 41,0, siliconata fronte/retro, riutilizzabile, idonea per tutti i tipi di pasta.



SILPAT Silicone baking sheet

Tappeto silicone
Silikonbackmatte
Tapis cuisson en silicone
Tapete de cocción silicona

art.	dim. cm.	GN
47680-40	40x30	-
47680-53	53x32,5	1/1
47680-60	60x40	-



SILPAIN Silicone baking sheet

Tappeto silicone
Silikonbackmatte
Tapis de cuisson en silicone
Tapete de cocción silicona

art.	dim. cm.	GN
47685-53	53x32,5	1/1
47685-60	60x40	-



ROUL'PAT Silicone baking sheet

Tappeto silicone
Silikonbackmatte
Tapis de cuisson en silicone
Tapete de cocción silicona

art.	dim. cm.
47688-60	60x40



Baking paper, PTFE coated

Carta da forno, rivestimento PTFE
Backtrennfolie, PTFE-beschichtet
Feuille de cuisson, revêtement PTFE
Papel de horno anti-adherente

art.	dim. cm.	U. Pack
47681-60	60x40	10

Fiberglass tissue coated on both sides, can be used up to 500 times, tear-proof. Carefully dry after use. – Tessuto fibra di vetro rivestito fronte/retro, resistente alla trazione, antiaderente, riutilizzabile più di 500 volte. Asciugare dopo l'uso.



Baking sheet, silicone, microperforated

Tappeto silicone microforato
Silikonbackmatte, microperforiert
Tapis cuisson en silicone, microperforé
Tapete de cocción silicona, microperforado

art.	dim. cm.
47691-53	52x31,5
47691-64	58,5x38,5



Baking sheet, silicone

Tappeto silicone
Silikonbackmatte
Tapis cuisson en silicone
Tapete de cocción silicona

art.	dim. cm.
47689-53	53x32,5
47689-60	60x40

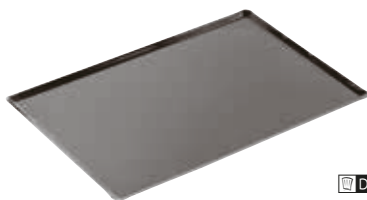

DEMARLE

Baking tray, aluminum, silicone coated

Teglia, alluminio siliconato
Alu-Backblech, Silikonbeschichtet
Plaque alu, revêtement silicone
Placa aluminio siliconada

art.	dim. cm.	GN
41743D32	32,5x53	1/1
41743D53	53x65	-
41743D60	40x60	-

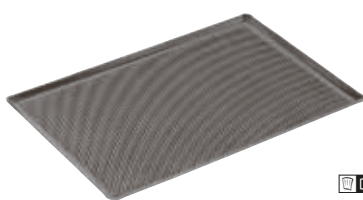

DEMARLE

Baking tray, perforated aluminum, silicone coated

Teglia, alluminio siliconato, forato
Alu-Backblech, gelocht, Silikonbeschichtet
Plaque alu perforée, revêtement silicone
Placa aluminio perforada siliconada

art.	dim. cm.	GN
41753D30	30x40	-
41753D32	32,5x53	1/1
41753D53	53x65	-
41753D60	40x60	-



Acetate sheets

Acetato in fogli
Acetat Band-Blätter
Feuilles en acétate
Hojas de acetato

art.	my	dim. cm.	pcs/pz
47131-30	90	30x30	50
47131-60	90	60x40	50



PVC ribbon

Nastro PVC
PVC Band
Ruban pâtissier en PVC
Cinta PVC

art.	my	h. cm.	mt.
47130-25	90	2,5	305
47130-30	90	3,0	305
47130-35	90	3,5	305
47130-40	90	4,0	305
47130-45	90	4,5	305
47130-50	90	5,0	305
47130-55	90	5,5	305
47130-60	90	6,0	305



Baking beans, ceramic

Noccioli di cottura, ceramica
Backkerne, Keramik
Noyaux de cuisson, céramique
Núcleos de cocción, cerámica

art.	Kg.
47011-01	1



SS

Tart ring

Anello per torte
Tortenring
Cercle à tarte
Anillo para tartas

art.	Ø cm.	h. cm.
47533-07	7	2
47533-08	8	2
47533-09	9	2
47533-10	10	2
47533-12	12	2
47533-14	14	2
47533-16	16	2
47533-18	18	2
47533-20	20	2
47533-22	22	2
47533-24	24	2
47533-26	26	2
47533-28	28	2
47533-30	30	2
47533-32	32	2



SS

Tart ring

Anello per torte
Tortenring
Cercle à tarte
Anillo para tartas

art.	Ø cm.	h. cm.
47530-14	14	3,5
47530-16	16	3,5
47530-18	18	3,5
47530-20	20	3,5
47530-22	22	3,5
47530-24	24	3,5
47530-26	26	3,5
47530-28	28	3,5
47530-30	30	3,5



SS

Mousse ring

Anello per mousse
Schaumspeisenring
Cercle à mousse
Anillo para mousse

art.	Ø cm.	h. cm.
47532-06	6,0	4,0
47532-07	7,5	4,0
47532-08	8,0	4,5
47532-12	12,0	4,5
47532-14	14,0	4,5
47532-16	16,0	4,5
47532-18	18,0	4,5
47532-20	20,0	4,5
47532-22	22,0	4,5
47532-24	24,0	4,5
47532-26	26,0	4,5



SS

Ice cream cake ring

Anello per torte gelato
Eistortenring
Cercle à vacherin
Circulo alto

art.	Ø cm.	h. cm.
47534-07	7	9
47534-08	9	9
47534-09	7	11
47534-10	9	11



SS

Ice cream cake ring

Anello per torte gelato
Eistortenring
Cercle à vacherin
Circulo alto

art.	Ø cm.	h. cm.
47534-00	8	6
47534-01	10	6



SS

Ice cream cake ring

Anello per torte gelato
Eistortenring
Cercle à vacherin
Circulo alto

art.	Ø cm.	h. cm.
47534-06	6	6
47534-16	16	6
47534-18	18	6
47534-20	20	6
47534-22	22	6
47534-24	24	6
47534-26	26	6
47534-28	28	6



SS

Cake setting ring, flexible

Anello regolabile, flessibile
Tortenring, verstellbar, flexible
Cercle à tarte réglable, flexible
Anillo ajustable, flexible

art.	Ø cm.	h. cm.
47529-07	16,5>32	7



SS

Extensible frame

Telaio regolabile
Backrahm, verstellbar
Bande à tarte réglable
Marco para tarta, ajustable

art.	Ø cm.	h. cm.
47526-05	30x30>57x56	5



SS

Extensible frame

Telaio regolabile
Backrahm, verstellbar
Bande à tarte réglable
Marco para tarta, ajustable

art.	Ø cm.	h. cm.
47528-05	19x28>34x54	5



NEW

SS

Extensible heart frame

Telaio cuore regolabile
Herz-Backrahm, verstellbar
Bande à tarte réglable
Marco para tarta, ajustable

art.	Ø cm.	h. cm.
47542-00	14,5>26,5	5



SS

Rectangle
Rettangolo
Rechteck
Rectangle
Rectangular

art.	dim. cm.
47527-55	55x35,5x4,5



SS

Rectangle
Rettangolo
Rechteck
Rectangle
Rectangular

art.	dim. cm.
47546-18	18x36x5
47546-30	30x40x5
47546-40	40x60x5

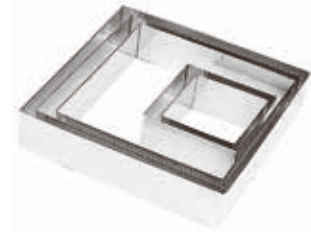

SS

Square
Quadrato
Viereck
Carré
Cuadrado

art.	dim. cm.
47548-02	10x10x4,5
47548-03	18x18x4,5
47548-04	20x20x4,5
47548-05	22x22x4,5



SS

Rounded square
Quadrato bombato
Viereck, konvex
Carré arrondi
Cuadrado abombado

art.	dim. cm.
47541-02	10x10x4,5
47541-03	18x18x4,5
47541-04	20x20x4,5



SS

Oval
Ovale
Oval
Ovale
Oval

art.	dim. cm.
47547-22	24,5x20x4
47547-26	30x23x4
47547-30	33x26,5x4



SS

Comma
Virgola
Komma
Virgule
Coma

art.	Ø cm.	h. cm.
47544-20	20	4
47544-25	25	4
47544-30	30	4



SS

Heart
Cuore
Herz
Coeur
Corazón

art.	Ø cm.	h. cm.
47542-18	18	4
47542-20	20	4
47542-22	22	4
47542-24	24	4
47542-26	26	4



SS

Triangle
Triangolo
Dreieck
Dreieck
Triangle
Triángulo

art.	Ø cm.	h. cm.
47540-02	12	4,5
47540-03	20	4,5
47540-04	22	4,5
47540-05	24	4,5



SS

Triangle
Triangolo
Dreieck
Dreieck
Triangle
Triángulo

art.	Ø cm.	h. cm.
47538-20	20	4
47538-23	23	4
47538-26	26	4



SS

Rectangle
Rettangolo
Rechteck
Rectangle
Rectangular

art.	dim. cm.
47546-21	25x9x2
47546-22	30x9,1x2
47546-23	35x9,2x2



SS

Rectangle
Rettangolo
Rechteck
Rectangle
Rectangular

art.	dim. cm.
47546-41	25x9x4
47546-42	30x9,1x4
47546-43	35x9,2x4



SS

Rectangle
Rettangolo
Rechteck
Rectangle
Rectangular

art.	dim. cm.
47546-51	25x9x5
47546-52	30x9,1x5
47546-53	35x9,2x5

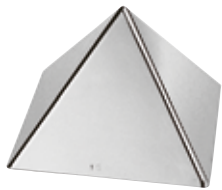

SS

Pyramid
Piramide
Pyramide
Piramide
Pirámide

art.	Ø cm.	h. cm.
47535-09	9	6
47535-12	12	8
47535-15	15	10
47535-17	17	12
47535-19	19	13



SS

Half sphere
Semi-sfera
Halbkugel
Demi-sphère
Semiesfera

art.	Ø cm.	h. cm.
47536-12	12	6
47536-14	14	7
47536-16	16	8
47536-18	18	9
47536-20	20	10



SS

Crème caramel
Crème caramel
Crème caramel
Crème caramel
Molde para flan

art.	Ø cm.	h. cm.	ml.
41660-10	7	5	150
41660-15	7	6	180

MICROPERFORATED CAKE RINGS
FASCE MICROFORATE

SS

The micro-holes allow to support the edges of the cake avoiding to collapse during cooking. They also allow to expel the moisture from the dough, obtaining a perfect and always crispy cooking.

I microfori permettono di sostenere i bordi della torta evitandone il collasso in cottura. Consentono inoltre di espellere l'umidità, ottenendo una cottura sempre perfetta e croccante.



Cake ring, microperforated
Fascia microforata
Tortenring mikroperforiert
Cercle microperforé
Anillo tarta microperforado

art.	Ø cm.	h. cm.
47510-07	7	3,5
47510-09	9	3,5
47510-11	11	3,5
47510-13	13	3,5
47510-15	15	3,5
47510-17	17	3,5
47510-19	19	3,5
47510-21	21	3,5
47510-23	23	3,5
47510-25	25	3,5
47510-27	27	3,5
47510-29	29	3,5
47510-31	31	3,5



Cake ring, microperforated
Fascia microforata
Tortenring mikroperforiert
Cercle microperforé
Anillo tarta microperforado

art.	Ø cm.	h. cm.
47511-07	7	2
47511-09	9	2
47511-11	11	2
47511-13	13	2
47511-15	15	2
47511-17	17	2
47511-19	19	2
47511-21	21	2
47511-23	23	2
47511-25	25	2
47511-27	27	2
47511-29	29	2
47511-31	31	2

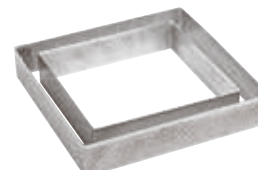

Cake ring, microperforated
Fascia microforata
Tortenring mikroperforiert
Cercle microperforé
Anillo tarta microperforado

art.	dim. cm.	h. cm.
47512-07	7x7	3,5
47512-09	9x9	3,5
47512-11	11x11	3,5
47512-13	13x13	3,5
47512-15	15x15	3,5
47512-17	17x17	3,5
47512-19	19x19	3,5
47512-21	21x21	3,5
47512-23	23x23	3,5
47512-25	25x25	3,5
47512-27	27x27	3,5
47512-29	29x29	3,5
47512-31	31x31	3,5



Piepan, aluminum
Tortiera, alluminio
Tortenform, Aluminium
Tourtière, alu
Molde, aluminio

art.	Ø cm.	h. cm.
16940-28	28	5,0
16940-32	32	5,5
16940-36	36	6,0
16940-40	40	6,5



Savarin tin, aluminum
Ciambella, alluminio
Savarinform, Aluminium
Moule à savarin, alu
Molde para savarin, aluminio

art.	Ø cm.	h. cm.	U. Pack
47060-06	6,0	2,5	3
47060-07	7,5	3,0	3
47060-09	9,0	3,5	3
47060-10	10,0	3,5	3
47060-12	12,0	5,5	3
47060-14	14,0	5,5	3
47060-16	16,0	5,5	3
47060-18	18,0	6,5	3
47060-20	20,0	6,5	3
47060-22	22,0	6,5	3
47060-24	24,0	8,5	3
47060-26	26,0	8,5	3
47060-30	30,0	8,5	3



Pandoro mold, aluminum
Stampo pandoro, alluminio
Pandoro-Form, Aluminium
Moule à pandoro, aluminium
Molde pandoro, aluminio

art.	gr.
47063-01	100
47063-02	250
47063-05	500
47063-07	750
47063-10	1000



Gugelhupf, aluminum
Stampo americano, alluminio
Gugelhupfform, Aluminium
Moule à gugelhupf, alu
Molde gugelhupf, aluminio

art.	Ø cm.	h. cm.
47062-18	18	10,5
47062-20	20	11,0
47062-22	22	12,0



Plumcake, aluminum
Plumcake, alluminio
Plumcake, Aluminium
Plumcake, alu
Molde para plumcake, aluminio

art.	dim. cm.
47064-18	18x80x6
47064-22	22x90x7
47064-26	26x10x8
47064-30	30x11x9



Beaker shaped tin, aluminum
Stampo per babà, alluminio
Timbalform, Aluminium
Moule à dariole, alu
Molde, aluminio

art.	Ø cm.	h. cm.	U. Pack
47066-03	3	3,5	10
47066-04	4	4,5	10
47066-05	5	5,5	10
47066-06	6	6,0	10
47066-07	7	7,0	10
47066-08	8	8,0	10



Crème caramel, aluminum
Crème caramel, alluminio
Crème caramel, Aluminium
Crème caramel, alu
Molde crème caramel, aluminio

art.	Ø cm.	h. cm.	U. Pack
41659-06	6	4,8	6
41659-07	7	5,0	6
41659-08	8	5,3	6



Cassata mold, aluminum
Stampo cassata, alluminio
Cassataform, Aluminium
Moule à cassata, alu
Molde para cassata, aluminio

art.	Ø cm.	h. cm.
47068-12	12	10
47068-15	15	12



Zuccotto mold, aluminum
Stampo per zuccotto, alluminio
Zuccottoform, Aluminium
Moule à zuccotto, alu
Molde para zuccotto, aluminio

art.	Ø cm.
47069-10	10
47069-12	12
47069-14	14
47069-16	16
47069-18	18
47069-20	20

NON STICK CAKE MOLDS TORTIERE ANTIADERENTI

PASTRY
PASTICCERIA



Wash the mold before the first use. Slightly grease inside surface with oil, butter or margarine before baking. Allow cake to cool down a little before removing from the mold. For the cleaning, hand-wash with dish soap and dry the mold immediately after washing. Use only in traditional ovens (no microwave). Do not use sharp objects or others metal tools which could damage the pan surface. Do not use on a flame or other direct heat source, including stove tops. Do not exceed 230°C. Non-stick coating PFOA free.

Lavare lo stampo prima di utilizzarlo la prima volta. Ungere leggermente l'interno con olio, burro o margarina prima di infornare. Prima di sfornare, lasciare raffreddare per qualche minuto. Lavare a mano con detersivi liquidi ed asciugare lo stampo immediatamente dopo. Utilizzare esclusivamente in forni tradizionali (no microonde). Non utilizzare oggetti appuntiti, polveri abrasive o pagliette metalliche che possano rigare la superficie degli stampi. Evitare il contatto con fonti di calore dirette o fiamma libera. Non superare la temperatura massima di 230°C. Rivestimento antiaderente privo di PFOA.



Pine mold

Tortiera pino
Tannenbaumform
Tourtière pin
Molde pino

art.	dim. cm.
47005-24	17x24x8,5



Star mold

Tortiera stella
Sternform
Tourtière étoile
Molde estrella

art.	dim. cm.
47006-25	25x25x4,5



Heart pan

Stampo cuore
Herz-Backblech
Plaque coeur
Molde corazón

art.	dim. cm.
47751-23	23x24,5x4,5

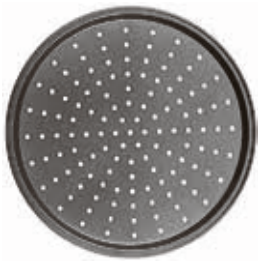

Crispy tart pan

Tortiera forata
Tortenform, gelocht
Tourtière perforée
Molde perforado

art.	Ø cm.	h. cm.
41729-30	30	1,3
41729-34	34	1,3



Round cake tin

Tortiera tonda
Tortenform, rund
Tourtière ronde
Molde redondo

art.	Ø cm.	h. cm.	U. Pack
47739-12	12	2,1	6
47739-24	24	2,3	1
47739-28	28	2,3	1
47739-32	32	2,5	1



Round cake tin

Tortiera tonda
Tortenform, rund
Manqué rond uni
Molde redondo

art.	Ø cm.	h. cm.
47710-12	12	3,0
47710-16	16	4,0
47710-20	20	4,5
47710-24	24	5,0
47710-28	28	5,0
47710-32	32	5,5



Round mold, fluted edges

Tortiera festonata
Runde Obsttortenform
Tourtière ronde bord cannelé
Molde rizado

art.	Ø cm.	h. cm.
47709-20	20	2,5
47709-24	24	2,5
47709-28	28	2,5
47709-32	32	2,5



Round mold, fluted, loose bottom

Tortiera festonata, fondo mobile
Tortenform, gewellter Rand, Hebeboden
Tourtière cannelée, fond amovible
Molde acanalado, rizado, fondo desmontable

art.	Ø cm.	h. cm.
47712-20	20	2,5
47712-24	24	2,5
47712-28	28	2,5
47712-32	32	2,5



Savarin tin

Ciambella
Savarinform
Moule pour savarin
Molde Savarin

art.	Ø cm.	h. cm.	U. Pack
47711-08	8	2,0	6
47711-12	12	2,5	6
47711-22	22	4,5	1
47711-24	24	5,0	1
47711-26	26	6,2	1



Trois Frères cake ring
Tortiera trois frères
Frankfurter Kranzform
Tourtière trois frères
Molde trois frères

art.	Ø cm.	h. cm.	U. Pack
47713-22	22	5,5	6



Gugelhupf cake pan
Stampo americano
Gugelhupfppform
Moule à gugelhupf
Molde gugelhupf

art.	Ø cm.	h. cm.
47705-22	22	10



Loaf pan
Tortiera rettangolare
Königskuchenform
Cake embouti
Molde rectangular

art.	dim. cm.
47714-26	26x9,5x7,5
47714-28	28x10x7,5



Rectangular mold, loose plate bottom
Tortiera, fondo mobile
Backform, gerippt, Heheboden
Tourtière cannelée, fond amovible
Molde fondo desmontable

art.	dim. cm.
47717-35	35x11x2,5



Square mold, fluted, loose bottom
Tortiera festonata, fondo mobile
Tortenform, gewellter Rand, Heheboden
Tourtière carrée, cannelée, fond amovible
Molde cuadrado, rizado, fondo desmontable

art.	dim. cm.
47738-23	23x23x2,5



Baking mold Daisy
Tortiera margherita
Margeriten-Backform
Moule à marguerite
Molde margarita

art.	Ø cm.	h. cm.
47718-20	20	6



Round mold, fluted, loose bottom
Tortiera festonata, fondo mobile
Tortenform, gewellter Rand, Heheboden
Tourtière cannelée, fond amovible
Molde acanalado, fondo desmontable

art.	Ø cm.	h. cm.	U. Pack
47719-10	10	3	6
47719-24	25	5	1



Round mold, fluted, loose bottom
Tartelletta festonata, fondo mobile
Runde, gewellte Tortellets, Heheboden
Tartelette ronde cannelée, fond amovible
Molde redondo rizado, fondo desmontable

art.	Ø cm.	h. cm.	U. Pack
47758-10	10	1,8	6
47758-12	12	2,0	6



Charlotte mold
Charlotte
Charlotte-Form
Charlotte
Molde Charlotte

art.	Ø cm.	h. cm.	U. Pack
47734-18	18	10	6



Bavaois mold
Bavarese
Bayerische-Kuchenform
Moule Bavarois
Molde Bávaro

art.	Ø cm.	h. cm.
47735-18	18	9



Rectangular cake mold
Tortiera rettangolare
Königskuchenform
Cake évasé
Molde ensanchado

art.	dim. cm.
47733-18	18x7,5x6,5
47733-24	24x9x7,5
47733-30	30x10x8
47733-36	36x10,5x8



Folding loaf pan
Tortiera rettangolare apribile
Aufklappbare-Königskuchenform
Cake ouvrant
Molde rectangular desmontable

art.	dim. cm.
47715-30	30x10x7,5



Rectangular baking sheet

Teglia rettangolare
Rechteckige-Backform
Plaque rectangulaire
Placa rectangular

art. dim. cm.
47716-37 37x26x1,3



Loaf pan with hinges, loose bottom

Bacinella paté con cerniera, fondo mobile
Springkastenform, Heheboden
Pâté à charnière, fond démontable
Molde con bisagra, fondo desmontable

art. dim. cm.
47736-30 30x8x8
47736-35 35x8x8
47736-40 40x8x8
47736-50 50x8x8



Mini paté mold

Stampo mini-paté
Pastetenkastenform
Mini-pâté à croûte
Molde minipaté

art. dim. cm.
47018-30 30x4x6
47018-50 50x4x6



Loaf pan

Stampo carré
Königskuchenform
Cake évasé
Molde ensanchado

art. dim. cm.
47752-09 9,5x6x3,8



Loaf pan

Stampo carré
Königskuchenform
Cake évasé
Molde ensanchado

art. dim. cm.
47752-16 15x7,5x4,8



Loaf pan

Stampo carré
Königskuchenform
Cake évasé
Molde ensanchado

art. dim. cm.
47752-21 21x10,8x5,8



Fluted loaf pan

Stampo carré, fondo festonato
Königskuchenform, gerippt
Cake évasé, fond cannelé
Molde ensanchado, fondo rizado

art. dim. cm.
47753-31 31x12x5

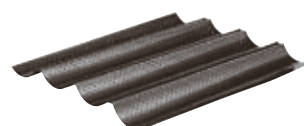

Baguette baking pan

Teglia baguettes
Baguetteform
Plaque à baguettes
Placa para baguettes

art. dim. cm.
47014-35 35x24,5x2,5



Oval aspic mold

Aspic ovale
Ovale Aspikform
Aspic ovale
Molde oval

art. dim. cm. U. Pack
47726-07 7,5x5,5x3,8 6



Oval aspic mold, star bottom

Aspic ovale, fondo stella
Ovale Aspikform, Sternboden
Aspic ovale, étoilé
Molde oval, fondo estrella

art. dim. cm. U. Pack
47727-07 7,5x5,5x3,8 6



Rum baba mold

Stampo babà
Runde Babaform
Dariole embouti
Molde para babà

art. Ø cm. h. cm. U. Pack
47728-06 6 6 6



Wine leaf tart mold

Tartelletta foglia di vite
Törtchenform Weinblatt
Tartelette feuille vigne
Molde pasteles

art. Ø mm. h. cm. U. Pack
47760-12 12 2 6



Oak leaf tart mold

Tartelletta foglia di quercia
Törtchenform Eichenblatt
Tartelette feuille chêne
Molde pasteles

art. Ø cm. h. cm. U. Pack
47759-12 12 2 6



Savarin mold

Tartelletta savarin
Savarinmörtchen
Savarin
Molde savarin

art. Ø mm. h. cm. U. Pack
47757-65 6,5 1,5 6
47757-80 8,0 2,0 6



Oval boat mold

Tartelletta barchetta
Schiffchenförmchen
Barquette unie

Molde barquilla

art.	dim. cm.	U. Pack
47720-06	6x2x1	6
47720-08	8x3,3x1,2	6
47720-10	10x4,3x1,3	6
47720-12	12x5x1,3	6



Fluted oval boat mold

Tartelletta barchetta, festonata
Schiffchenförmchen, gerippt
Barquette, cannelée

Molde barquilla, rizado

art.	dim. cm.	U. Pack
47721-08	8x4x1,2	6
47721-10	10x4,5x1,2	6
47721-12	12x5x1,4	6



Round plain mold

Tartelletta tonda
Backförmchen, rund
Tartelette ronde, unie

Molde redondo

art.	Ø cm.	U. Pack
47722-05	5	6
47722-06	6	6
47722-07	7	6
47722-08	8	6
47722-10	10	6



Small mold

Tartelletta
Törtchenform
Petit four

Molde pasteles

art.	Ø cm.	U. Pack
47723-05	5	6
47723-06	6	6
47723-07	7	6
47723-08	8	6
47723-10	10	6
47723-12	12	6



Brioche mold

Tartelletta a brioche
Brioche-Förmchen
Tartelette brioche

Molde brioche

art.	Ø cm.	U. Pack
47724-06	6	6
47724-08	8	6
47724-10	10	6
47724-11	11	6



Friand mold

Tartelletta rettangolare
Friand-Förmchen
Friand

Molde rectangular

art.	dim. cm.	U. Pack
47725-09	10x5x1,4	6



Box of small assorted molds

Scatola tartelletta assortite
Satz Förmchen
Boîte petits fours, assortis

Surtido moldes

art.	pcs/pz
47730-24	24
47730-36	36
47730-60	60



Small mold

Tartelletta
Törtchenform
Petit four

Molde pasteles

art.	dim. cm.	U. Pack
47747-03	4,5x3	6

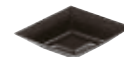

Small mold

Tartelletta
Törtchenform
Petit four

Molde pasteles

art.	dim. cm.	U. Pack
47747-06	6x3	6



Small mold

Tartelletta
Törtchenform
Petit four

Molde pasteles

art.	Ø cm.	h. cm.	U. Pack
47747-10	4,0	1,0	6
47747-11	3,5	1,4	6



Small mold

Tartelletta
Törtchenform
Petit four

Molde pasteles

art.	Ø cm.	U. Pack
47747-01	4,5	6



Small mold

Tartelletta
Törtchenform
Petit four

Molde pasteles

art.	dim. cm.	U. Pack
47747-04	3,5x3,5	6



Small mold

Tartelletta
Törtchenform
Petit four

Molde pasteles

art.	dim. cm.	U. Pack
47747-07	6x3	6



Small mold

Tartelletta
Törtchenform
Petit four

Molde pasteles

art.	Ø cm.	U. Pack
47723-05	5	6



Small mold

Tartelletta
Törtchenform
Petit four

Molde pasteles

art.	dim. cm.	U. Pack
47747-05	4,5x2,5	6



Small mold

Tartelletta
Törtchenform
Petit four

Molde pasteles

art.	dim. cm.	U. Pack
47747-09	5x3	6



Madeleine sheet

Stampo per madeleines
Madeleine-Backblech
Plaque madeleines

Molde Madeleine

art.	dim. cm.
47731-12	26x20



Madeleinette sheet

Stampo per madeleinettes
Madeleinette-Backblech
Plaque madeleinettes

Molde Madeleine

art.	dim. cm.
47732-20	39,5x12,5



Cup bun pan

Stampo tartellette
Backblech
Plaque tartelettes
Molde pasteles

art.	Ø cm.	dim. cm.
47748-35	6,5	35,5x27x2,5



Snowman mold

Stampo pupazzo di neve
Schneemann-Backblech
Plaque bonhomme de neige
Molde muñeco de nieve

art.	dim. cm.
47763-31	31x19,7x5



Snowman mold

Stampo pupazzo di neve
Schneemann-Backblech
Plaque bonhomme de neige
Molde muñeco de nieve

art.	dim. cm.
47762-23	23x5



Christmas style mold

Stampo di Natale
Weihnachts-Backblech
Plaque de Noël
Molde de Noel

art.	dim. cm.
47750-06	31,5x21,5x2,5



Santa Claus mold

Stampo Babbo Natale
Weihnachtsmann-Backblech
Plaque Père Noël
Molde Papà Noel

art.	dim. cm.
47761-23	23x4,8



Easter muffin pan

Stampo motivi pasquali
Ostern-Backblech
Plaque Pâque
Molde Pascua

art.	dim. cm.
47749-35	35x27x3



Egg mold

Stampo uovo
Ostereierform
Moule à oeuf
Molde para huevos

art.	dim. cm.
47007-26	26x8,3



Easter rabbit mold

Stampo coniglietto di Pasqua
Osternhase-Backblech
Plaque lapin de Pâque
Molde conejo de Pascua

art.	dim. cm.
47764-12	12x2,6



Easter rabbit mold

Stampo coniglio di Pasqua
Osternhase-Backblech
Plaque lapin de Pâque
Molde conejo de Pascua

art.	dim. cm.
47764-28	28x5,4



Springform mold with 6 bottoms

Stampo apribile, 6 fondi
Springform mit 6 Böden
Manqué démontable, 6 fonds
Molde desmontable, 6 fondos

art.	Ø cm.	h. cm.
47755-26	26	6



Springform mold

Stampo apribile
Springform
Manqué démontable
Molde desmontable

art.	Ø cm.	h. cm.
47754-20	20,5	6,5
47754-24	24,0	6,5
47754-26	26,0	6,5
47754-28	28,0	6,7



Fluted springform pan

Stampo ciambella apribile
Savarinspringform
Manqué savarin démontable
Molde savarin desmontable

art.	Ø cm.	h. cm.
47756-20	20,5	4,7
47756-24	24,0	6,8
47756-26	26,0	6,5
47756-28	28,0	6,7

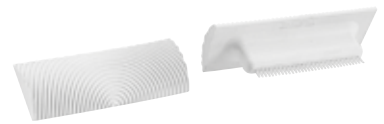

Rubber comb, wood effect

Tampone finto legno
Kamm aus Kunststoff, holzartig
Peigne faux bois
Peine de goma, efecto madera

art.	cm.
47684-15	15



Log mold, plastic

Stampo per tronco, plastica
Kastenform, Kunststoff
Gouttière, plastique
Molde, plástico

art.	dim. cm.
47659-01	48x6,5x7
47659-02	48x6,5x7
47659-03	48x6,5x7
47659-04	48x5,0x4

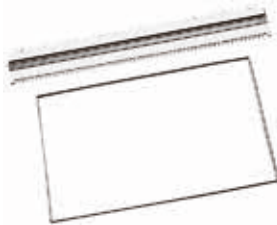

Comb for Charlotte with frame

Pettine Charlotte con telaio
Charlotte-Kamme mit Rahmen
Peigne à Charlotte avec cadre
Peine para Charlotte con marco

art.	dim. cm.
47670-02	57x36,5

SS



Comb with 5 rubber blades

Pettine con 5 fasce gomma
Kamm mit 5 Gummiklingen
Peigne avec 5 bandes à décor
Peine con 5 láminas de goma

art.	dim. cm.
47672-05	70x10

SS

BISCUIT DECORATION FRAMES 60X40
GRIGLIE DECORO BISCUIT 60X40



Place the grill on silicone mat. Spread uniformly the decorating paste. Take off the grid and put into refrigerator. Afterwards spread uniformly the biscuit. Bake in the oven at 230°C for 8 minutes. Place the biscuit upside down on a greaseproof paper and remove carefully the silicone mat. By using an extensible pastry cutter cut the biscuit into stripes.

Appoggiare la griglia su un tappeto di silicone. Spatolare la pasta decoro uniformemente. Togliere la griglia e passare in congelatore. Successivamente stendere il biscuit. Cuocere in forno a 230°C per 8 minuti, appoggiare il biscuit capovolto su un foglio e togliere delicatamente il tappeto. Tagliare le fasce di biscuit nella larghezza desiderata.



S/steel frame - Griglia inox
art.

47674-01



S/steel frame - Griglia inox
art.

47674-02



S/steel frame - Griglia inox
art.

47674-03



S/steel frame - Griglia inox
art.

47674-04



S/steel frame - Griglia inox
art.

47674-05



S/steel frame - Griglia inox
art.

47674-06



S/steel frame - Griglia inox
art.

47674-07



S/steel frame - Griglia inox
art.

47674-08

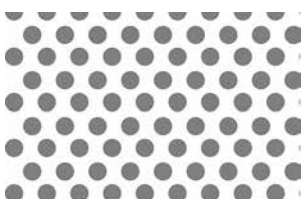

Plastic frame - Griglia plastica

art. Ø cm.
47677-01 0,7

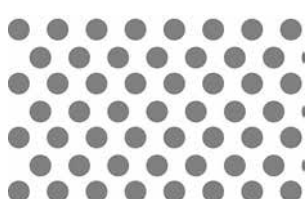

Plastic frame - Griglia plastica

art. Ø cm.
47677-02 0,9

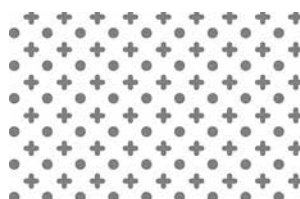

Plastic frame - Griglia plastica

art.
47677-03

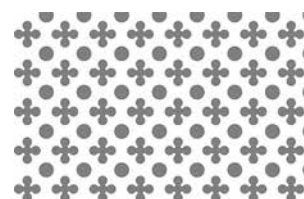

Plastic frame - Griglia plastica

art.
47677-04



Plastic frame - Griglia plastica

art.
47677-05

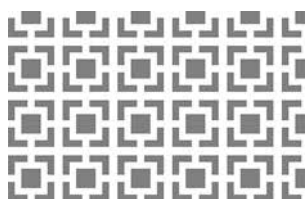

Plastic frame - Griglia plastica

art.
47677-06



Plastic frame - Griglia plastica

art.
47677-07



Plastic frame - Griglia plastica

art.
47677-08

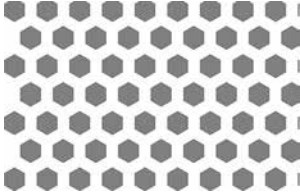

Plastic frame - Griglia plastica

art.
47677-09

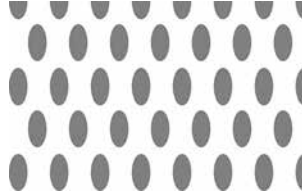

Plastic frame - Griglia plastica

art.
47677-10

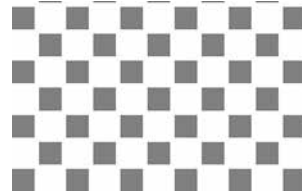

Plastic frame - Griglia plastica

art.
47677-11



Plastic frame - Griglia plastica

art.
47677-12

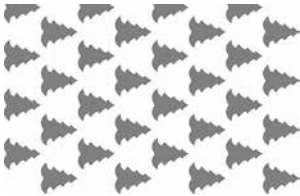

Plastic frame - Griglia plastica

art.
47677-13

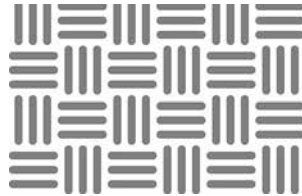

Plastic frame - Griglia plastica

art.
47677-14

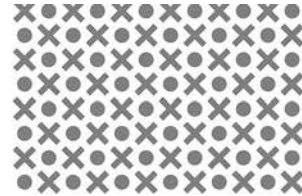

Plastic frame - Griglia plastica

art.
47677-15

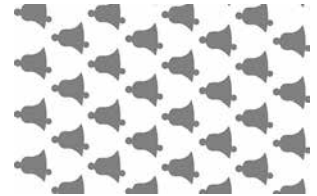

Plastic frame - Griglia plastica

art.
47677-16

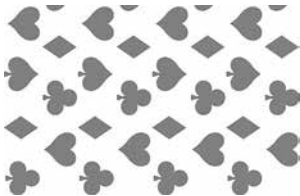

Plastic frame - Griglia plastica

art.
47677-17



Plastic frame - Griglia plastica

art.
47677-18

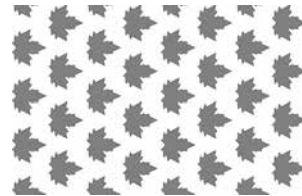

Plastic frame - Griglia plastica

art.
47677-19

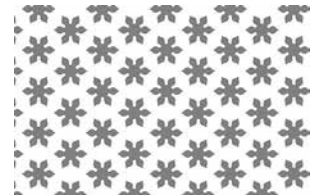

Plastic frame - Griglia plastica

art.
47677-20



Cookie cutter frame

Placca biscotti
Ausstechmatte
Plaque coupe biscuits
Rejilla corta galletas

art.	Ø cm.	dim. cm.	pcs/pz
47675-01	8,8	58x39	20



Cookie cutter frame

Placca biscotti
Ausstechmatte
Plaque coupe biscuits
Rejilla corta galletas

art.	Ø cm.	dim. cm.	pcs/pz
47675-02	4,5	58x39	72

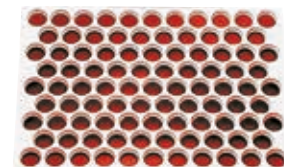

Cookie cutter frame

Placca biscotti
Ausstechmatte
Plaque coupe biscuits
Rejilla corta galletas

art.	Ø cm.	dim. cm.	pcs/pz
47675-03	5,5	58x39	53

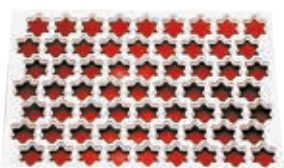

Cookie cutter frame

Placca biscotti
Ausstechmatte
Plaque coupe biscuits
Rejilla corta galletas

art.	Ø cm.	dim. cm.	pcs/pz
47675-04	5,2	58x39	63

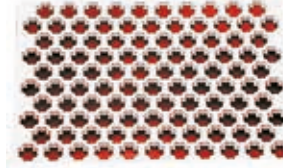

Cookie cutter frame

Placca biscotti
Ausstechmatte
Plaque coupe biscuits
Rejilla corta galletas

art.	Ø cm.	dim. cm.	pcs/pz
47675-05	4,5	58x39	60

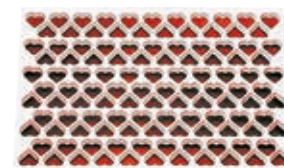

Cookie cutter frame

Placca biscotti
Ausstechmatte
Plaque coupe biscuits
Rejilla corta galletas

art.	Ø cm.	dim. cm.	pcs/pz
47675-06	4	58x39	95

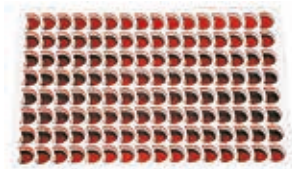

Cookie cutter frame

Placca biscotti
Ausstechmatte
Plaque coupe biscuits
Rejilla corta galletas

art.	Ø cm.	dim. cm.	pcs/pz
47675-07	5	58x39	78

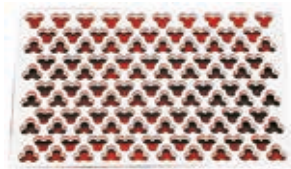

Cookie cutter frame

Placca biscotti
Ausstechmatte
Plaque coupe biscuits
Rejilla corta galletas

art.	Ø cm.	dim. cm.	pcs/pz
47675-08	5	58x39	68

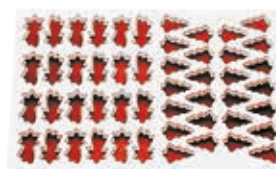

Cookie cutter frame

Placca biscotti
Ausstechmatte
Plaque coupe biscuits
Rejilla corta galletas

art.	Ø cm.	dim. cm.	pcs/pz
47675-09	6-7,5	58x39	24-26

**MONOPORTION TRAY MOLDS
TEGLIE MONOPORZIONI**



Tray cm. 60x40

Teglia
Blech
Plaque
Bandeja

art.	dim. mm.	pcs/pz	gr.
47651-01	Ø 44 h 25	96	20
47651-02	55x35x25	96	20
47651-03	46x46x25	96	20
47651-04	60x38x25	96	20
47651-05	58x39x25	96	20
47651-07	38x38x25	96	20



Extractor

Estrattore
Extraktor
Extracteur
Extractor

art.	dim. mm.
47656-01	Ø 44 h 25
47656-02	55x35x25
47656-03	46x46x25
47656-04	60x38x25
47656-05	58x39x25
47656-07	38x38x25



Cutter

Tagliapasta
Ausstechform
Coupe-pâte
Cortador

art.	dim. mm.
47655-01	Ø 44 h 25
47655-02	55x35x25
47655-03	46x46x25
47655-04	60x38x25
47655-05	58x39x25
47655-07	38x38x25



Tray cm. 60x40

Teglia
Blech
Plaque
Bandeja

art.	dim. mm.	pcs/pz	gr.
47652-01	Ø 67 h 40	35	75
47652-02	86x50x40	35	75
47652-03	74x71x40	35	75
47652-04	90x58x40	35	75
47652-05	88x60x40	35	75
47652-07	59x59x40	35	75



Estractor

Estrattore
Extraktor
Extracteur
Extractor

art.	dim. mm.
47658-01	Ø 67 h 40
47658-02	86x50x40
47658-03	74x71x40
47658-04	90x58x40
47658-05	88x60x40
47658-07	59x59x40



Cutter

Tagliapasta
Ausstechform
Coupe-pâte
Cortador

art.	dim. mm.
47657-01	Ø 67 h 40
47657-02	86x50x40
47657-03	74x71x40
47657-04	90x58x40
47657-05	88x60x40
47657-07	59x59x40



Stencil cm. 31x51

art.	dim. cm.	pcs/pz
47875-11	13x3	30



Stencil cm. 31x51

art.	dim. cm.	pcs/pz
47875-13	7,5x3,5	40



Stencil cm. 31x51

art.	dim. cm.	pcs/pz
47875-14	6,5x4	32

PRALINE'S SILICONE MOLDS CM 19X29
STAMPI IN SILICONE PER PRALINE CM 19X29



Practical, flexible and resistant silicone molds for sweet or salty creations (snaks, truffles, jellies, pralines). Perfect to make large quantities in short time. They withstand from -40° to +250°C. Can be used in the oven, refrigerator and blast chiller.

Pratici stampi in silicone flessibili e resistenti per creazioni dolci o salate (snack, tartufi, gelatine, praline). Ideali per realizzare grandi quantità in poco tempo. Resistono da -40° a +250°C. Utilizzabili in forno, frigorifero e abbattitore.

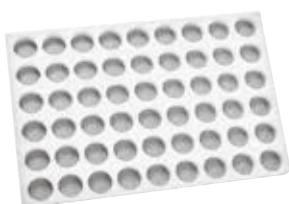

Chocoflex - psc/pz 54

art.	Ø mm.	h.
47783-01	26	14

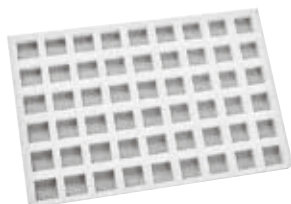

Chocoflex - psc/pz 54

art.	dim. mm.
47783-02	23x23x14

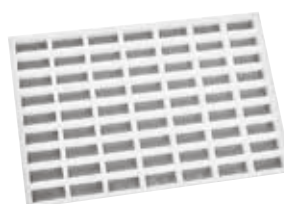

Chocoflex - psc/pz 63

art.	dim. mm.
47783-03	35x14,5x14



Chocoflex - psc/pz 49

art.	dim. mm.
47783-04	32x21x14

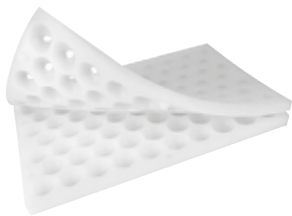

Chocoflex - psc/pz 54

art.	Ø mm.	h.
47783-11	26	14



Chocoflex - psc/pz 40

art.	Ø mm.	h.
47783-12	30-10	12



Chocoflex - psc/pz 15

art.	dim. mm.
47783-13	90x30x19



Chocoflex - psc/pz 15

art.	dim. mm.
47783-14	90x30x19

CHOCOLATE
CIOCCOLATO

PC



Polycarbonate chocolate molds. Mold size 17,5x27,5 cm.

Stampi polycarbonato. Misure stampo 17,5x27,5 cm.



Chocolate/Ciocolato Praline

art.	dim. mm.	pcs/pz
47860-17	30x30x12	24



Chocolate/Ciocolato Praline

art.	Ø mm.	h.	pcs/pz
47860-18	27	17	24



Chocolate/Ciocolato Praline

art.	Ø mm.	h.	pcs/pz
47860-21	29	18	24



Chocolate/Ciocolato Praline

art.	dim. mm.	pcs/pz
47860-24	40x42x15	15



Chocolate/Ciocolato Praline

art.	dim. mm.	pcs/pz
47860-27	27x27x13	28



Chocolate/Ciocolato Praline

art.	dim. mm.	pcs/pz
47860-31	33x25x12	24



Chocolate/Ciocolato Praline

art.	Ø mm.	h.	pcs/pz
47860-35	30	19	28



Chocolate/Ciocolato Praline

art.	dim. mm.	h.	pcs/pz
47860-36	25x25x25	25	40



Chocolate/Ciocolato Praline

art.	dim. mm.	pcs/pz
47860-37	36x22x20	36



Chocolate/Ciocolato Praline
art. dim. mm. pcs/pz
47860-38 48x18,5x19 16



Chocolate/Ciocolato Praline
art. dim. mm. pcs/pz
47860-39 30x18x15 30



Chocolate/Ciocolato Praline
art. Ø mm. h. pcs/pz
47860-40 29 21 40



Chocolate/Ciocolato Praline
art. dim. mm. pcs/pz
47860-42 35x23x16 36



Chocolate/Ciocolato Praline
art. dim. mm. pcs/pz
47860-43 38x28x18 30



Chocolate/Ciocolato Praline
art. dim. mm. pcs/pz
47860-44 28x32x15 32



Chocolate/Ciocolato Praline
art. dim. mm. pcs/pz
47860-46 35x20x17 30



Chocolate/Ciocolato Praline
art. Ø mm. h. pcs/pz
47860-48 28 24 40



Chocolate/Ciocolato Praline
art. Ø mm. h. pcs/pz
47860-49 30 22 28



Chocolate/Ciocolato Praline
art. Ø mm. h. pcs/pz
47860-50 26 15 35



Chocolate/Ciocolato Praline
art. dim. mm. pcs/pz
47860-53 22x22x22 28



Chocolate/Ciocolato Praline
art. dim. mm. pcs/pz
47860-55 26x20x21 28



Chocolate/Ciocolato Praline
art. Ø mm. h. pcs/pz
47860-56 24 21 28



Chocolate/Ciocolato Praline
art. dim. mm. pcs/pz
47860-57 26x20x21 28



Chocolate/Ciocolato Praline
art. dim. mm. pcs/pz
47860-58 17x12x5 130



Chocolate/Ciocolato Praline
art. Ø mm. h. pcs/pz
47860-60 25 18,5 28



Chocolate/Ciocolato Praline
art. dim. mm. pcs/pz
47860-61 30x20x17,5 28



Chocolate/Ciocolato Praline
art. Ø mm. h. pcs/pz
47860-62 27 20 30



Chocolate/Ciocolato Praline

art.	Ø mm.	h.	pcs/pz
47860-63	27	20	30



Chocolate/Ciocolato Praline

art.	dim. mm.	pcs/pz
47860-66	25x25x15	30



Chocolate/Ciocolato Praline

art.	dim. mm.	pcs/pz
47860-67	25x25x15	30



Chocolate/Ciocolato Praline

art.	Ø mm.	h.	pcs/pz
47860-68	28	25	40



Chocolate/Ciocolato Praline

art.	dim. mm.	pcs/pz
47860-69	40x20x18	30



Chocolate/Ciocolato Praline

art.	dim. mm.	pcs/pz
47860-70	40x18x15	30



Chocolate/Ciocolato Praline

art.	dim. mm.	pcs/pz
47860-71	26x26x20	30



Chocolate/Ciocolato Praline

art.	dim. mm.	pcs/pz
47860-73	31x22x22	5x6



Chocolate/Ciocolato Praline

art.	dim. mm.	pcs/pz
47860-74	32x32x4	24



Chocolate/Ciocolato Praline

art.	dim. mm.	pcs/pz
47860-75	20x20x16	28



Chocolate/Ciocolato Praline

art.	dim. mm.	pcs/pz
47860-81	30x18x15	30



Chocolate/Ciocolato Praline

art.	dim. mm.	pcs/pz
47860-83	30x30x15	24



Chocolate/Ciocolato Praline

art.	Ø mm.	h.	pcs/pz
47860-84	26	19	35



Chocolate/Ciocolato Praline

art.	dim. mm.	pcs/pz
47860-85	35x22x16	35



Chocolate/Ciocolato Praline

art.	dim. mm.	pcs/pz
47860-95	25x25x13	24



Chocolate/Ciocolato Praline

art.	Ø mm.	h.	pcs/pz
47860-96	35	15	24



Chocolate/Cioccolato Praline

art.	dim. mm.	pcs/pz
47862-31	28x28x16	28



Chocolate/Cioccolato Praline

art.	dim. mm.	pcs/pz
47862-32	24x24x18	28



Chocolate/Cioccolato Praline

art.	dim. mm.	pcs/pz
47862-33	40x42x16	15



Chocolate/Cioccolato Praline

art.	dim. mm.	pcs/pz
47862-34	41x24x20	20



Chocolate/Cioccolato Praline

art.	dim. mm.	pcs/pz
47862-35	30x30x11	28



Chocolate/Cioccolato Praline

art.	dim. mm.	pcs/pz
47862-36	35x23x17	24



Chocolate/Cioccolato Bars

art.	dim. mm.	pcs/pz
47862-38	50x26x3	16



Chocolate/Cioccolato Bars

art.	dim. mm.	pcs/pz
47862-39	74x33x5	12



Chocolate/Cioccolato Fill

art.	dim. mm.	pcs/pz
47862-03	32x24x29	24



Chocolate/Cioccolato Fill

art.	dim. mm.	pcs/pz
47862-04	44x56x39	12



Chocolate/Cioccolato Fill

art.	Ø mm.	h.	pcs/pz
47862-05	40	17	15



Chocolate/Cioccolato Fill

art.	dim. mm.	pcs/pz
47862-06	33x31x20	24



Chocolate/Cioccolato Fill

art.	dim. mm.	pcs/pz
47862-07	33x33x23	24



Chocolate/Cioccolato Fill

art.	dim. mm.	pcs/pz
47862-08	44x55x23	12



Chocolate/Cioccolato Fill

art.	Ø mm.	h.	pcs/pz
47862-09	40	18,5	15



Chocolate/Ciocolato Fill

art.	Ø mm.	h.	pcs/pz
47862-10	32	37	20



Tray/Vassoio

art.	dim. cm.	pcs/pz
47862C10	38x10x2,5	20



Chocolate/Ciocolato Decoration

art.	dim. mm.	pcs/pz	gr.
47862-70	64x26	16	2/3



Chocolate/Ciocolato Decoration

art.	dim. mm.	pcs/pz	gr.
47862-71	47x39	15	2/3



Chocolate/Ciocolato Decoration

art.	dim. mm.	pcs/pz	gr.
47862-72	110x7	22	3/4



Chocolate/Ciocolato Decoration

art.	dim. mm.	pcs/pz	gr.
47862-73	66x21	18	2/3



Chocolate/Ciocolato Decoration

art.	dim. mm.	pcs/pz	gr.
47862-74	65x22	18	2/3



Chocolate/Ciocolato Decoration

art.	dim. mm.	pcs/pz	gr.
47862-75	71x71	18	2/3



Chocolate/Ciocolato Decoration

art.	Ø mm.	pcs/pz	gr.
47862-76	51>73	18	2/3



Chocolate/Ciocolato Decoration

art.	dim. mm.	pcs/pz	gr.
47862-77	68x81	18	2/3



Letters & Numbers

art.	h. cm.
47860-86	3

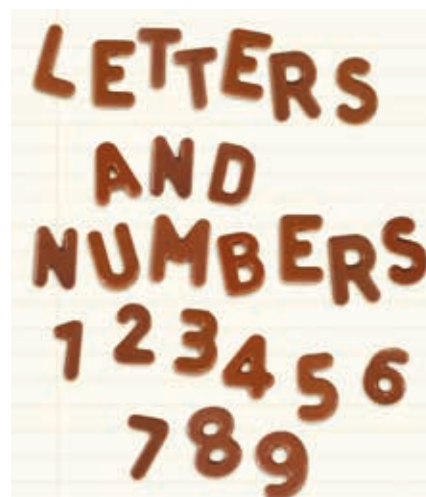

Spheres/Sfere

art.	Ø mm.	pcs/pz	gr.
47860-76	30	24	4



Spheres/Sfere

art.	Ø mm.	pcs/pz	gr.
47860-77	50	8	15



Spheres/Sfere

art.	Ø mm.	pcs/pz	gr.
47860-78	100	2	90

SILKSCREENED PRALINES MM 275 × 135
PRALINE SERIGRAFATE MM 275 × 135

PC



Place the silk screen sheet on the base of the mold, cutting it to the right size. Put the sheet with the transfer part facing upwards and close the mold. Fill with chocolate and leave to cool. When cool, open the mold and turn out the chocolates.

Collocare il foglio serigrafato sul fondo dello stampo tagliandolo a misura. Posare il foglio con la parte trasferibile verso l'alto e chiudere lo stampo. Riempire gli stampi e lasciare solidificare il cioccolato. Raffreddati, sformare i cioccolatini.



Magnetic mold pcs 15
Stampo magnetico gr 13

art. Ø mm.
47863-01 30



Magnetic mold pcs 15
Stampo magnetico gr 15

art. dim. mm.
47863-02 33X25



Magnetic mold pcs 15
Stampo magnetico gr 13

art. dim. mm.
47863-03 27X27



Magnetic mold pcs 15
Stampo magnetico gr 10

art. dim. mm.
47863-04 27X25



PE

Chocolate bars, set 5 pcs
Tavolette cioccolato, set 5 pz
Schokoladentafel, 5 Stk
Tablettes chocolat, 5 pièces
Tabletas chocolate, 5 piezas

art. dim. cm.
47870-17 15x17
47870-18 15x17
47870-19 15x17





PC

Spoon mold
Stampo cucchiaino
Löffelform
Moule à cuillère
Molde cuchara

art.	dim. mm.
47860-90	25x95



PC

Coffee cup mold
Stampo tazza caffè
Kaffeetassenform
Moule tasse à café
Molde taza café

art.	Ø mm.	h.	pcs/pz
47860-91	51	32	7
47860-92	59	36	7

Mold/Stampo 17,5x27,5 cm.



PC

Saucer mold
Stampo piattino
Untertassenform
Moule de soucoupe
Molde platillo

art.	Ø mm.	pcs/pz
47860-93	80	5
47860-94	91	3

Mold/Stampo 17,5x27,5 cm.



Half egg mold, strong plastic (PETG)
Stampo 1/2 uovo, plastica rigida
Ostereierform 1/2
Moule à 1/2 oeuf
Molde para 1/2 huevo

art.	dim. cm.	Kg.
47876-11	17x25	0,5-1,0
47876-12	18x28	0,8-1,2
47876-13	34x25	1,5-2,0
47876-14	27x40	2,0-2,5
47876-15	32x45	2,5-3,5
47876-16	36x54	4,0-6,0
47876-17	43x64	6,0-8,0
47876-18	50x75	8,0-10,0



PC

Half egg mold
Stampo 1/2 uovo
Ostereierform 1/2
Moule à 1/2 oeuf
Molde para 1/2 huevo

art.	dim. mm.	pcs/pz	gr.
47862-80	44x64	10	25
47862-81	75x105	4	70
47862-82	90x130	2	150
47862-83	104x150	2	230
47862-84	121x175	1	260
47862-85	141x204	1	380
47862-86	157x227	1	430



PE

Egg mold
Stampo uovo
Ostereierform
Moule à oeuf
Molde para huevos

art.	dim. mm.	pcs/pz
47865-44	220x160x85	1
47865-23	110x80x40	2
47865-80	112x83x44	2
47865-81	125x94x44	2
47865-82	140x100x50	2
47865-83	154x110x55	2



PE

Egg mold
Stampo uovo
Ostereierform
Moule à oeuf
Molde para huevos

art.	dim. mm.	pcs/pz
47865-66	80x60x25	4
47865-73	40x31x17	14
47865-71	36x23x12	18



PE

Egg mold
Stampo uovo
Ostereierform
Moule à oeuf
Molde para huevos

art.	dim. mm.	pcs/pz
47865-74	64x44x26	6
47865-72	39x25x13	14



PE

Egg mold
Stampo uovo
Ostereierform
Moule à oeuf
Molde para huevos

art.	dim. mm.	pcs/pz
47865-77	140x100x49	1
47865-76	95x70x40	2
47865-75	83x54x24	4

3D HOLLOW MOLDS/STAMPI 3D CORPO CAVO
3D-HOHLFORME/MOULES CREUSES 3D/MOLDE 3D

PC



Easter/Pasqua

art.	h. mm.
47793-11	170



Easter/Pasqua

art.	h. mm.
47793-12	180



Easter/Pasqua

art.	h. mm.
47793-13	140



Easter/Pasqua

art.	h. mm.	#
47793-15	170	2



Easter/Pasqua

art.	h. mm.
47793-16	150



Easter/Pasqua

art.	h. mm.	#
47793-17	160	2
47793-18	205	1



Easter/Pasqua

art.	h. mm.
47793-19	110
47793-20	160



Easter/Pasqua

art.	h. mm.	#
47793-21	125	2



Easter/Pasqua

art.	h. mm.	#
47793-22	125	2



Easter/Pasqua

art.	h. mm.	#
47793-23	110	3



Easter/Pasqua

art.	h. mm.
47793-24	145



Easter/Pasqua

art.	h. mm.	#
47793-25	97	2



Easter/Pasqua

art.	h. mm.
47793-26	110
47793-27	140



Christmas/Natale

art.	h. mm.	#
47793-32	122	3



Christmas/Natale

art.	h. mm.
47793-33	180



Christmas/Natale

art.	h. mm.
47793-40	168



Christmas/Natale

art.	h. mm.
47793-41	185



Christmas/Natale

art.	h. mm.
47793-42	180



Christmas/Natale

art.	h. mm.	#
47793-43	114	3



Christmas/Natale

art.	h. mm.
47793-44	192



Christmas/Natale

art.	h. mm.
47793-45	135



Shoe/Scarpa

art.	dim. mm.
47793-51	195x60x80



Ball/Pallone

art.	h. mm.
47793-52	120



Pumpkin/Zucca

art.	dim. mm.
47793-53	95x90x110



Pumpkin/Zucca

art.	dim. mm.
47793-54	140x140x150



Shoe/Scarpa

art.	dim. mm.
47793-55	220x75x170

FRUITS/TUTTIFRUTTI



Silicone molds cm 40x30, to create original dessert and surprising monoportions.

Stampi in silicone cm 40x30, per realizzare dessert al piatto e monoporzioni.



Pear
Pera

art.	Ø mm.	h.	ml.	pcs/pz
47745-06	53	70	90	20

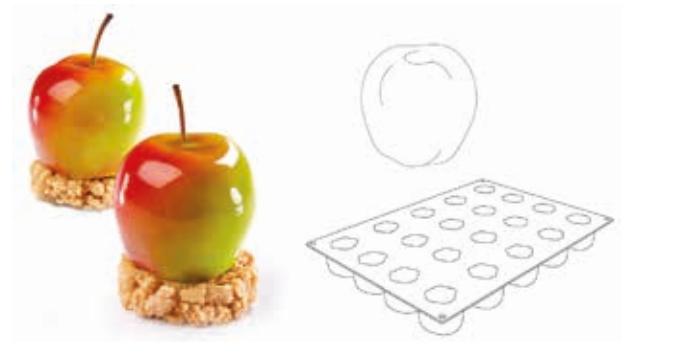

Apple
Mela

art.	Ø mm.	h.	ml.	pcs/pz
47745-07	55	48	90	20

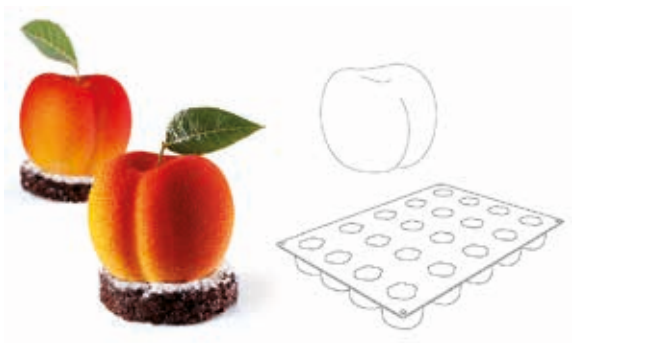

Peach/Cherry
Pesca/Ciliegia

art.	dim. mm.	ml.	pcs/pz
47745-08	58x53x46	90	20

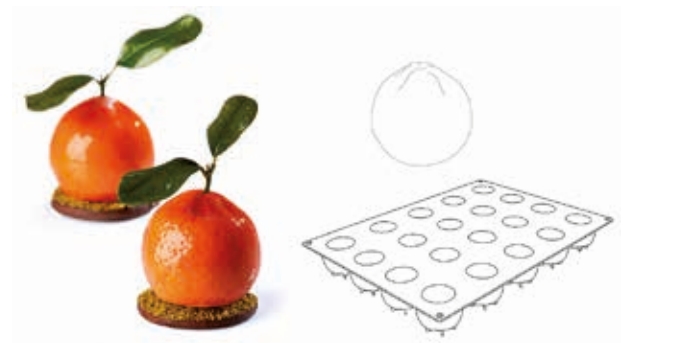

Tangerine
Mandarino

art.	Ø mm.	h.	ml.	pcs/pz
47745-09	57	50	90	20

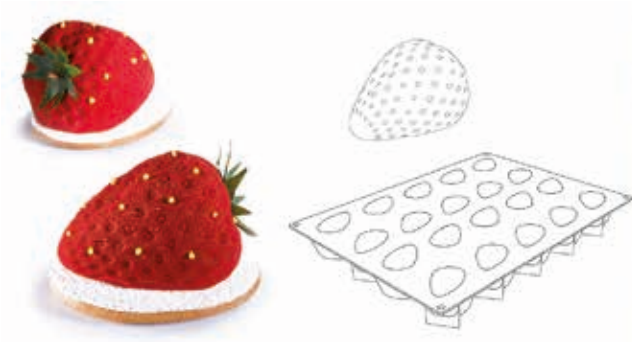

Strawberry

Fragola

art.	dim. mm.	ml.	pcs/pz
47745-10	71x54x46	90	20

**SILICONE MOLDS CM 60X40 - 40X30
STAMPI SILICONE CM 60X40 - 40X30**



Quenelle 60x40

art.	dim. mm.	ml.	pcs/pz
47746-01	66x33x30	32	49



Mini quenelle 60x40

art.	dim. mm.	ml.	pcs/pz
47746-02	42x20x20	8	100

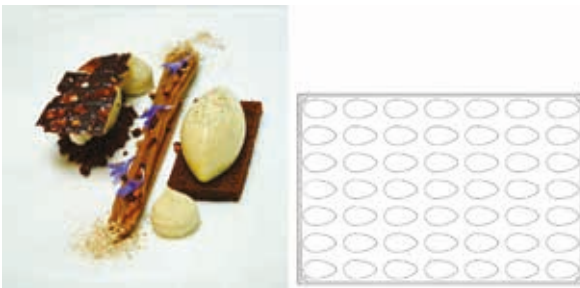

Quenelle 60x40

art.	dim. mm.	ml.	pcs/pz
47746-03	66x35x26	34	49



Mini quenelle 60x40

art.	dim. mm.	ml.	pcs/pz
47746-04	42x22x17	9	100



Curvy 60x40

art.	dim. mm.	ml.	pcs/pz
47746-05	200x130x65	960	6



Planet 60x40

art.	Ø mm.	h.	ml.	pcs/pz
47746-06	180	45	1.000	6



Galaxy 60x40

art.	Ø mm.	h.	ml.	pcs/pz
47746-07	175-55	55	1.000	6



Plissée 60x40

art.	Ø mm.	h.	ml.	pcs/pz
47746-08	180	47	1.000	6

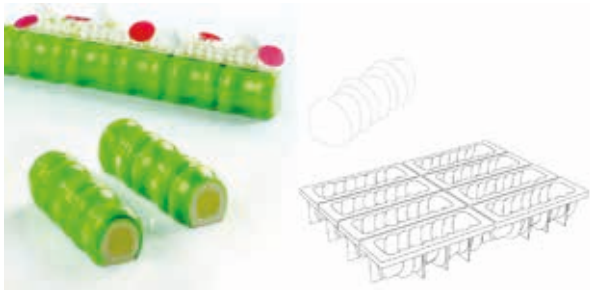

Bilbao 60x40

art.	dim. mm.	ml.	pcs/pz
47746-09	250x85x75	1.150	8



Planet 40x30

art.	Ø mm.	h.	ml.	pcs/pz
47745-01	38	20	18	30



Sphere 40x30

art.	Ø mm.	ml.	pcs/pz
47745-02	20	4	48



Sphere 40x30

art.	Ø mm.	ml.	pcs/pz
47745-03	30	14	30



Sphere 40x30

art.	Ø mm.	ml.	pcs/pz
47745-04	40	33	24



Sphere 40x30

art.	Ø mm.	ml.	pcs/pz
47745-05	50	65	20

MICRO-PERFORATED MOLDS 600X400 MM
STAMPI MICROFORATI 600X400 MM



Ideal for making both sweet and savoury products. Ensures a homogeneous baking even for the most difficult products, such as cream or fruit tarts. The sablé, brisée, shortcrust and any other type of pastry grip to the edges, without bubbles or sticking, avoiding border collapsing and enhancing the correct rising of the product.

Ideali per realizzare prodotti sia dolci che salati. Si ottiene una cottura uniforme anche dei prodotti da forno che faticano a cuocersi. La sablé, le frolle, la pasta brisée o qualsiasi altra pasta si aggrappa bene sui bordi, senza formare bolle e senza attaccarsi, evitando problemi di collassamento e valorizzando lo sviluppo della lievitazione in altezza.



ROUND SHAPES / FORME TONDE

art.	Ø mm.	h.	ml.	pcs/pz
47775-01	48	16	22	40



SQUARE SHAPES / FORME QUADRATE

art.	dim. mm.	ml.	pcs/pz
47775-02	85x85x20	127	12



SQUARE SHAPES / FORME QUADRATE

art.	dim. mm.	ml.	pcs/pz
47775-03	45x45x16	27	48



SQUARE SHAPES / FORME QUADRATE

art.	dim. mm.	ml.	pcs/pz
47775-04	65x65x20	71	24



SQUARE SHAPES / FORME QUADRATE

art.	dim. mm.	ml.	pcs/pz
47775-05	120x120x30	374	8



ROUND SHAPES / FORME TONDE

art.	Ø mm.	h.	ml.	pcs/pz
47775-06	40	16	16	60



ROUND SHAPES / FORME TONDE

art.	Ø mm.	h.	ml.	pcs/pz
47775-08	65	20	57	24

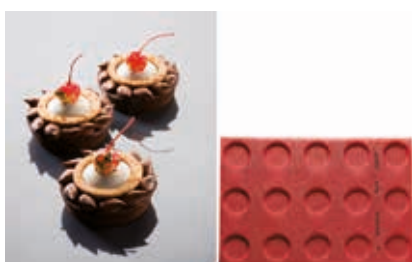

ROUND SHAPES / FORME TONDE

art.	Ø mm.	h.	ml.	pcs/pz
47775-09	80	20	88	15



ROUND SHAPES / FORME TONDE

art.	Ø mm.	h.	ml.	pcs/pz
47775-10	120	30	332	8



ROUND SHAPES / FORME TONDE

art.	Ø mm.	h.	ml.	pcs/pz
47775-11	100	20	140	12



ROUND SHAPES / FORME TONDE

art.	Ø mm.	h.	ml.	pcs/pz
47775-12	150	30	495	6



100% PLATINUM SILICONE CAKE MOLDS, CM 17,5X30 - GN 1/3
STAMPI IN SILICONE PLATINICO 100%, CM 17,5X30 - GN 1/3



Suitable for freezing and baking (resistance from -40°C up to +280°C). For a correct use, put the moulds on grills or perforated trays, in order to improve the heat diffusion during baking. High non-stick properties to let a perfect demoulding of the product. Can be washed by hand or in dishwasher. Manufactured in conformity with international regulations concerning food contact: D.M. no. 104 of 21/03/1973 (Italian law) - Arrêté du 25/11/1992 (French law) - BGVV (German law) - FDA (USA law).

Adatti per la surgelazione e la cottura (resistono da -40°C a +280°C). Per un utilizzo ottimale, posizionare gli stampi su griglie o teglie forate per favorire la diffusione del calore durante la cottura. Elevata antiaderenza per consentire una perfetta sformatura del prodotto. Lavabili a mano e in lavastoviglie. Conforme alle norme internazionali che regolano l'utilizzo di materiali destinati al contatto con sostanze alimentari: D.M. n. 104 del 21/03/1973 (legislazione italiana) - Arrêté du 25/11/1992 (legislazione francese) - BGVV (legislazione tedesca) - FDA (legislazione statunitense).



Big baba
Babà grande

art.	Ø mm.	h.	ml.	pcs/pz
47742-02	55	60	97	8



Medium baba
Babà medio

art.	Ø mm.	h.	ml.	pcs/pz
47742-30	45	48	51	11



Small baba
Babà piccolo

art.	Ø mm.	h.	ml.	pcs/pz
47742-31	35	38	25	15



Bavarian
Bavarese

art.	Ø mm.	h.	ml.	pcs/pz
47742-41	57	57	110	8



Fluted cake
Briochette cannellata

art.	Ø mm.	h.	ml.	pcs/pz
47742-12	79	30	109	6



Fluted cake
Briochette cannellata

art.	Ø mm.	h.	ml.	pcs/pz
47742-27	79	37	100	6



Cake

Cake

art.	dim. mm.	ml.	pcs/pz
47742-56	80x30x30	62	9



Cannelle

Cannelle

art.	Ø mm.	h.	ml.	pcs/pz
47742-51	56	50	70	8



Cylinder

Cilindro

art.	Ø mm.	h.	ml.	pcs/pz
47742-17	60	35	89	8



Heart

Cuore

art.	dim. mm.	ml.	pcs/pz
47742-25	65x60x35	97	8



Biscuit disc

Disco biscuit

art.	Ø mm.	h.	ml.	pcs/pz
47742-23	103	20	160	3



Florentine

Florentine

art.	Ø mm.	h.	ml.	pcs/pz
47742-19	60	12	27	8



Madeleine

Madeleine

art.	dim. mm.	ml.	pcs/pz
47742-21	68x45x18	30	9
47742-37	42x30x11,5	8	20



Mini cannelle

Mini cannelle

art.	Ø mm.	h.	ml.	pcs/pz
47742-42	35	35	24	18



Mini financier

Mini finanziere

art.	dim. mm.	ml.	pcs/pz
47742-14	49x26x11	11	20



Mini gughupf

Mini gughupf

art.	Ø mm.	h.	ml.	pcs/pz
47742-34	60	33	70	6



Mini muffin

Mini muffin

art.	Ø mm.	h.	ml.	pcs/pz
47742-20	50	28	43	11



Mini oval

Mini ovale

art.	dim. mm.	ml.	pcs/pz
47742-09	53x33x20	28	16



Mini pyramid

Mini piramide

art.	dim. mm.	ml.	pcs/pz
47742-13	36x36x22	13	15



Mini savarin

Mini savarin

art.	Ø mm.	h.	ml.	pcs/pz
47742-05	41	12	12	18



Muffin

Muffin

art.	Ø mm.	h.	ml.	pcs/pz
47742-08	70	40	130	6



Muffin

Muffin

art.	Ø mm.	h.	ml.	pcs/pz
47742-33	80	35	110	5



Petit four

Petit four

art.	Ø mm.	h.	ml.	pcs/pz
47742-24	40	20	22	15



Pyramid

Piramide

art.	dim. mm.	ml.	pcs/pz
47742-07	71x71x40	92	6



Pomponette
Pomponette

art.	Ø mm.	h.	ml.	pcs/pz
47742-06	34	16	13	24



Savarin
Savarin

art.	Ø mm.	h.	ml.	pcs/pz
47742-15	72	23	67	6



Savarin
Savarin

art.	Ø mm.	h.	ml.	pcs/pz
47742-10	65	21	49	8



Half sphere
Semisfera

art.	Ø mm.	h.	ml.	pcs/pz
47742-04	30	17	8,5	24



Half sphere
Semisfera

art.	Ø mm.	h.	ml.	pcs/pz
47742-03	40	20	17	15



Half sphere
Semisfera

art.	Ø mm.	h.	ml.	pcs/pz
47742-48	50	23	33	15



Half sphere
Semisfera

art.	Ø mm.	h.	ml.	pcs/pz
47742-47	60	30	57	8



Half sphere
Semisfera

art.	Ø mm.	h.	ml.	pcs/pz
47742-01	70	35	89	6



Half sphere
Semisfera

art.	Ø mm.	h.	ml.	pcs/pz
47742-29	80	40	134	5



Tartlet
Tartelletta

art.	Ø mm.	h.	ml.	pcs/pz
47742-16	50	15	20	15



Cakes
Tortine

art.	Ø mm.	h.	ml.	pcs/pz
47742-61	80	18	85	6



Round cake tin
Tortiera tonda

art.	Ø mm.	h.	ml.
47765-24	240	42	1850
47765-26	260	45	2250
47765-28	280	45	2600



Fluted round cake tin
Tortiera tonda cannellata

art.	Ø mm.	h.	ml.
47766-26	260	30	1350
47766-28	280	30	1600
47766-30	300	30	1850



Tart tin
Crostatina

art.	Ø mm.	h.	ml.
47771-28	280	30	1700



Heart cake tin
Tortiera cuore

art.	dim. mm.	ml.
47770-21	220x218x35	1150

NEW



Plumcake

Plumcake

art.	dim. mm.	ml.
47773-24	240x105x65	1385
47773-28	280x105x65	1660



Drainer

Sgocciolatore

art.	dim. cm.
47742-00	30x30x17,5



FLEXIPAN



PASTRY
PASTICCERIA



The Sasa Demarle Group is the only company in the world to formulate and produce its own food silicone, specially designed for the bakery and pastry industry. The use of this silicone allows an optimal heat distribution, which offers an even baking and colour, as well as perfect non-stick properties for an easy and perfect demoulding. The Flexipan moulds offer great performances with high lifetime expectancy: from 3,000 to 5,000+ baking cycles, depending on the conditions of use. Can be used for cooking and freezing (from -40°C to +240°C), for sweet and/or savory recipes. Can be easily cleaned with water.

Il gruppo Sasa Demarle è l'unica azienda al mondo a formulare e produrre il proprio silicone alimentare, appositamente progettato per l'industria della panificazione e della pasticceria. L'uso di questo silicone consente una distribuzione ottimale del calore, offrendo una cottura e un colore uniformi, nonché proprietà antiaderenti perfette per una facile e perfetta sfornatura. Gli stampi Flexipan offrono grandi prestazioni con un'elevata aspettativa di durata: da 3.000 a 5.000+ cicli di cottura, a seconda delle condizioni di utilizzo. Può essere utilizzato per cucinare e congelare (da -40°C a +240°C), per ricette dolci e/o salate. Si pulisce facilmente con acqua.

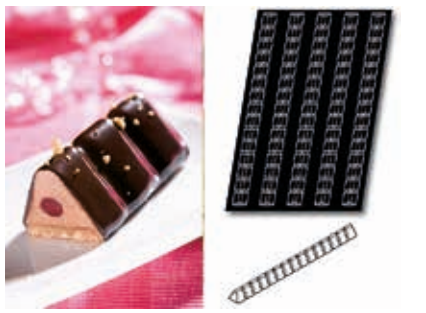

Annapurna

Pcs/pz 5 - ml. 370

art. mm.

47740137 495x40x33

With s/s frame. – Con supporto inox.



Bavarois

Pcs/pz 18 - ml. 100

art. Ø mm. h.

47740105 78 35



Bells

Pcs/pz 15 - ml. 130

art. mm.

47740136 102x92x29



Butterfly

Pcs/pz 24 - ml. 60

art. mm.

47740141 70x60x20



Caterpillar

Pcs/pz 5 - ml. 450

art. mm.

47740138 495x40x36

With s/s frame. – Con supporto inox.



Champagne biscuits

Pcs/pz 45 - ml. 20

art. mm.

47740-29 109x24x10



Charlotte

Pcs/pz 24 - ml. 60

art. Ø mm. h.

47740-80 62 35



Charlotte

Pcs/pz 18 - ml. 100

art. Ø mm. h.

47740-23 78 40

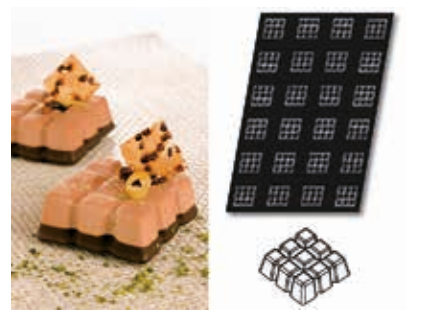

Chocolate bars

Pcs/pz 18 - ml. 100

art. mm.

47740128 78x58x40

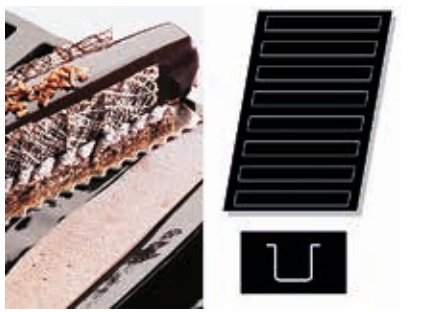

Christmas log

Pcs/pz 8 - ml. 450

art. mm.

47740-28 339x40x39

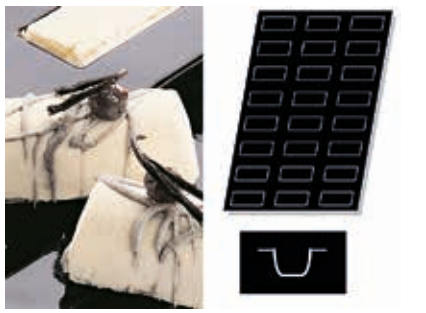

Christmas log

Pcs/pz 24 - ml. 80

art. mm.

47740-26 95x40x30



Christmas log

Pcs/pz 24 - ml. 115

art. mm.

47740-27 122x42x32



Christmas log insert

Pcs/pz 5 - ml. 700

art. mm.

47740-93 495x40x39

With s/s frame. – Con supporto inox.



Christmas tree

Pcs/pz 20 - ml. 100

art. mm.

47740119 90x85x30



Cylinders

Pcs/pz 24 - ø 63 mm.

art. h. mm. ml.

47740-52 25 65

47740-06 35 90



Cylinders

Pcs/pz 15

art. Ø mm. h. ml.

47740-69 82 50 220

47740-70 91 35 190

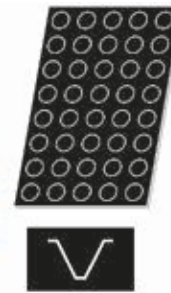

Cone insert

Pcs/pz 40 - ml. 24

art. Ø mm. h.

47740102 50 40

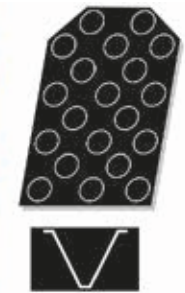

Cones

Pcs/pz 20 - ml. 80

art. Ø mm. h.

47740103 70 60



Cookies

art. Ø mm. h. ml. pcs

47740-18 59 13 30 40

47740-60 78 10 50 24



Cookies

Pcs/pz 12

art. Ø mm. h. ml.

47740-74 100 35 245

47740-75 105 40 305



Cookies

Pcs/pz 15 - ml. 60

art.
47740-61



Crown muffins

Pcs/pz 12 - ml. 185

art. Ø mm. h.

47740-76 108/51 44



Eggs

Pcs/pz 25 - ml. 95

art. mm.

47740135 94x60x31

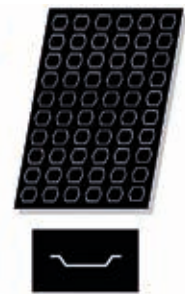

Exagon

Pcs/pz 60 - ml. 12

art. mm.

47740-83 45x40x12



Financiers

Pcs/pz 24 - ml. 45

art. mm.

47740-10 86x46x14



Fishes

Pcs/pz 18 - ml. 100

art. mm.

47740-139 99x59x25



Flan bases

Pcs/pz 24 - ml. 70

art. Ø mm. h.

47740-43 80 20



Fluted brioche

Pcs/pz 24 - ml. 60

art. mm.

47740-57 62x49x26



Fluted brioche

Pcs/pz 24

art. Ø mm. h. ml.

47740-58 68 25 60

47740-59 78 30 105

47740-16 81 37 105



Fluted cakes

Pcs/pz 16 - ml. 105

art. mm.

47740-95 110x60x25



Fluted ingots

Pcs/pz 24 - ml. 90

art. mm.

47740-127 106x46x25



Fluted tartlets

Pcs/pz 24 - ml. 70

art. mm.

47740-132 78x78x20



Half cylinder

Pcs/pz 48 - ml. 20

art. mm.

47740-125 85x17x15

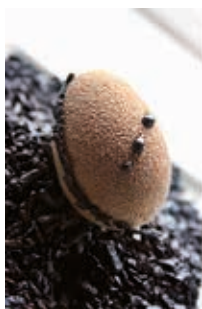

Half egg

Pcs/pz 56 - ml. 20

art. mm.

47740-140 55x35x20



Half sphere

Pcs/pz 48 - ml. 20

art. Ø mm. h.

47740-02 42 21



Half sphere

Pcs/pz 24 - ml. 125

art. Ø mm. h.

47740-38 80 40



Half sphere

Pcs/pz 28 - ml. 50

art. Ø mm. h.
47740-37 58 31



Half sphere

Pcs/pz 24 - ml. 105

art. Ø mm. h.
47740-03 70 40



Hearts

Pcs/pz 81 - ml. 20

art. mm.
47740-89 75x65x35

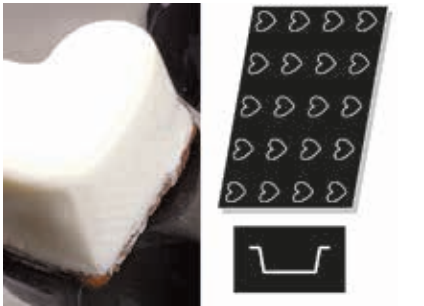

Hearts

Pcs/pz 20 - ml. 90

art. mm.
47740-41 66x62x35



Hexagons

Pcs/pz 20 - ml. 90

art. Ø mm. h.
47740130 80 25

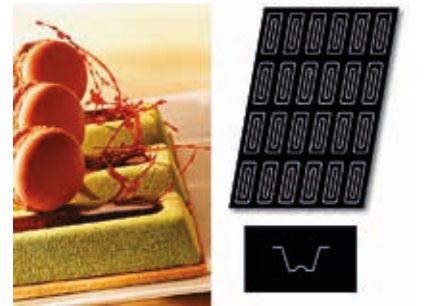

Hollow ingot

Pcs/pz 24

art. mm. ml.
47740123 100x40x25 70
47740124 120x40x25 90



Ingot

Pcs/pz 24 - ml. 100

art. mm.
47740122 120x40x25

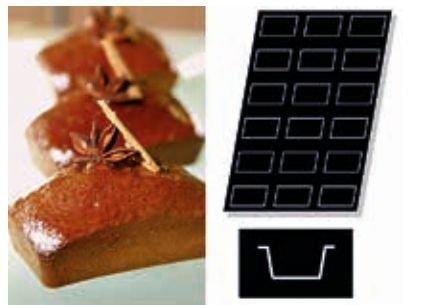

Ingot

Pcs/pz 18 - ml. 139

art. mm.
47740-94 102x58x30



Interlacing hearts

Pcs/pz 8 - ml. 200

art. mm.
47740101 120x113x35



Landscapes

Pcs/pz 27 - ml. 80

art. Ø mm. h.
47740144 75 24



Little cushion

Pcs/pz 24 - ml. 70

art. mm.
47740-77 71x57x23



Little shells

Pcs/pz 50 - ml. 27

art. mm.
47740-78 55x39x22



Little waves

Pcs/pz 24 - ml. 76

art. mm.

47740121 79x49x25



Madeleines

Pcs/pz 40 - ml. 35

art. mm.

47740-17 78x47x19



Medallions

Pcs/pz 54 - ml. 14

art. Ø mm. h.

47740-50 38 10



Medallions

Pcs/pz 96 - ml. 5

art. Ø mm. h.

47740-97 28 8



Mini Charlotte

Pcs/pz 60 - ml. 9

art. Ø mm. h.

47740-82 35 15



Mini chenilles

Pcs/pz 27 - ml. 90

art. mm.

47740143 102x40x36



Mini drops

Pcs/pz 56 - ml. 18

art. mm.

47740133 52x32x20



Mini écrins

Pcs/pz 24 - ml. 65

art. mm.

47740142 50x50x29



Mini Madeleines

Pcs/pz 56 - ml. 15

art. mm.

47740106 52x33x15



Mini St Honoré crown

Pcs/pz 18 - ml. 70

art. Ø mm. h.

47740131 80 20



Muffins

Pcs/pz 24

art. Ø mm. h. ml.

47740-19 73 40 125

47740-68 79 36 115



Optagon

Pcs/pz 40 - ml. 28

art. mm.

47740-34 43x40x26



Oval savorins

Pcs/pz 12 - ml. 230

art. mm.

47740-81 100x80x45



Oval savorins

Pcs/pz 30 - ml. 48

art. mm.

47740111 70x50x22



Oval savorins

Pcs/pz 24 - ml. 70

art. mm.

47740-44 80x60x25



Oval tartlets

Pcs/pz 30 - ml. 35

art. mm.

47740-32 106x45x15



Ovals

Pcs/pz 24 - ml. 80

art. mm.

47740-49 96x45x28



Ovals

Pcs/pz 30

art. mm. ml.

47740-46 70x50x25 55

47740-47 70x50x30 75



Ovals

Pcs/pz 20 - ml. 100

art. mm.

47740-48 85x60x30



Ovals

Pcs/pz 48 - ml. 15

art. mm.

47740-92 70x30x10



Ovals

Pcs/pz 24 - ml. 80

art. mm.

47740-55 130x48x18



Pomponnettes

Pcs/pz 96 - ml. 14

art. Ø mm. h.

47740-04 36 17



Puddings

Pcs/pz 15 - ml. 128

art. Ø mm. h.

47740104 65 55



Pyramids

Pcs/pz 24 - ml. 90

art. mm.

47740-13 71x71x41



Pyramids flat bottom

Pcs/pz 35 - ml. 50

art. mm.

47740-39 50x50x35

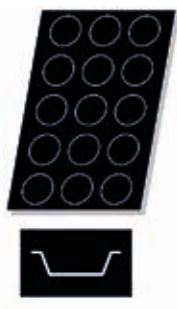

Quiches

Pcs/pz 15 - ml. 135

art. Ø mm. h.

47740-85 96 25

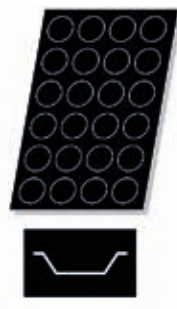

Quiches

Pcs/pz 24 - ml. 65

art. Ø mm. h.

47740-30 77 20



Quiches

Pcs/pz 42 - ml. 30

art. mm.

47740-45 60x40x25



Quiches

Pcs/pz 15 - ml. 140

art. Ø mm. h.

47740-62 102 20



Quiches

Pcs/pz 6

art. Ø mm. h. ml.

47740-64 147 12 200

47740-65 150 15 250

47740-66 166 12 250



Quiches

Pcs/pz 6

art. Ø mm. h. ml.

47740-71 140 25 360

47740-72 150 24 390

47740-05 186 12 300

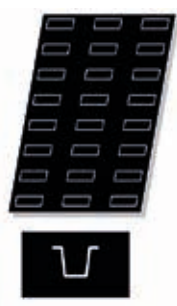

Rectangular cakes

Pcs/pz 24 - ml. 55

art. mm.

47740-25 80x30x30

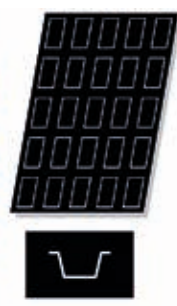

Rectangular cakes

Pcs/pz 25 - ml. 110

art. mm.

47740-24 89x46x25

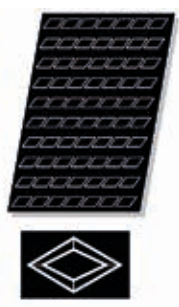

Rhombus

Pcs/pz 70 - ml. 9

art. mm.

47740-36 60x35x10



Round

Pcs/pz 11 - ml. 75

art. Ø mm. h.

47740-63 125 16



Round brioches

Pcs/pz 24 - ml. 65

art. Ø mm. h.

47740-56 79 15



Savarin zaphire

Pcs/pz 24 - ml. 80

art. mm.

47740114 70x70x32



Savarins

Pcs/pz 35 - ml. 50

art. Ø mm. h.

47740-20 66 20



Savarins

Pcs/pz 24 - ml. 65

art. Ø mm. h.

47740-15 70 23



Scoop out

Pcs/pz 24 - ml. 90

art. mm.

47740145 85x61x30



Shells

Pcs/pz 24 - ml. 70

art. mm.

47740-79 80x75x20

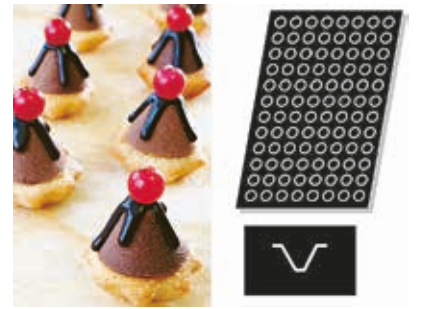

Small cones

Pcs/pz 96 - ml. 6

art. Ø mm. h.

47740-99 30 20

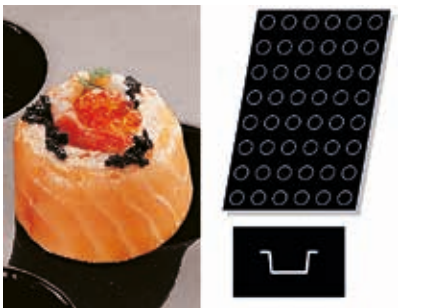

Small cylinders

Pcs/pz 48 - ml. 25

art. Ø mm. h.

47740-51 40 20



Small financiers

Pcs/pz 84 - ml. 10

art. mm.

47740-09 50x26x11

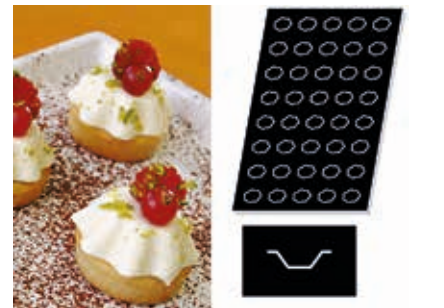

Small fluted tartlet

Pcs/pz 40 - ml. 11

art. mm.

47740100 46x38x15



Small half sphere

Pcs/pz 96 - ml. 6

art. Ø mm. h.

47740-87 26 16

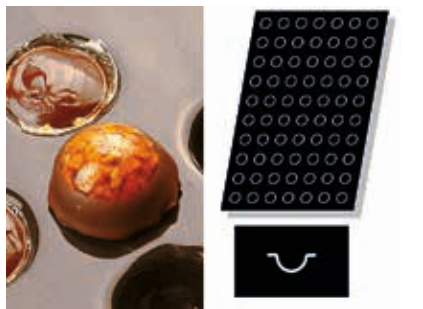

Small half sphere

Pcs/pz 70 - ml. 10

art. Ø mm. h.

47740-01 29 18



Small hearts

Pcs/pz 70 - ml. 15

art. mm.

47740115 41x38x16

**PASTRY PASTICCERIA
FLEXIPAN SILICONE 60X40 CM**



Small muffins

Pcs/pz 40 - ml. 45

art. Ø mm. h.
47740-67 51 29



Small oval savarins

Pcs/pz 60 - ml. 9

art. mm.
47740-98 40x30x12



Small oval tartlets

Pcs/pz 48 - ml. 10

art. mm.
47740-31 66x27x11



Small ovals

Pcs/pz 50 - ml. 20

art. mm.
47740-11 51x31x20



Small ovals flat bottom

Pcs/pz 64 - ml. 18

art. mm.
47740-91 57x35x12

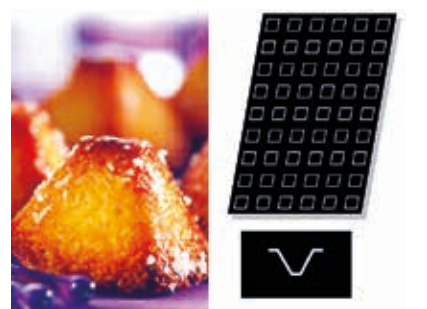

Small pyramids

Pcs/pz 54 - ml. 15

art. mm.
47740-12 35x35x23



Small quenelles

Pcs/pz 72 - ml. 56

art. mm.
47740-90 42x26x20



Small quiches

Pcs/pz 54 - ml. 22

art. Ø mm. h.
47740-33 40 20



Small quiches

Pcs/pz 60 - ml. 13

art. Ø mm. h.
47740-07 42 10



Small quiches

Pcs/pz 48 - ml. 20

art. Ø mm. h.
47740-08 48 15

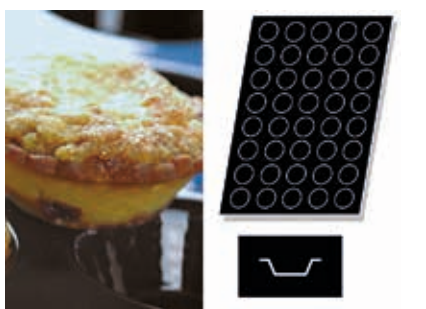

Small quiches

Pcs/pz 40 - ml. 35

art. Ø mm. h.
47740-84 58 20

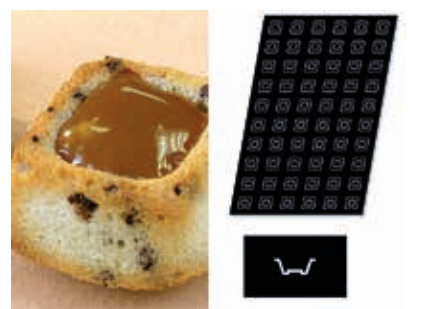

Small Savarins

Pcs/pz 60 - ml. 15

art. mm.
47740107 7x37x17

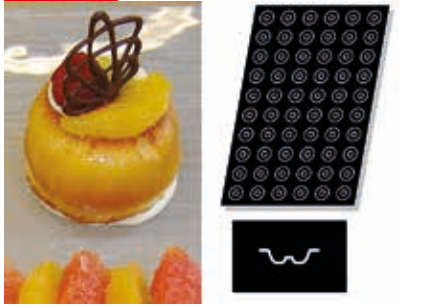

Small savarins

Pcs/pz 60 - ml. 10

art. Ø mm. h.
47740-14 41 12

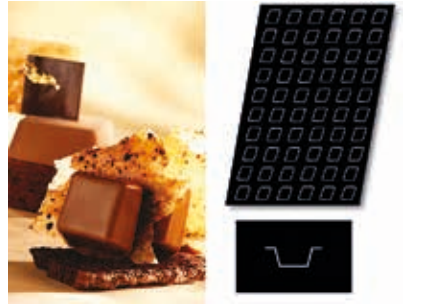

Small squares

Pcs/pz 60 - ml. 18

art. mm.
47740116 37x37x17



Small squares

Pcs/pz 60 - ml. 20

art. mm.
47740109 45x45x12



Small upside-down half sphere

Pcs/pz 45 - ml. 6

art. Ø mm. h.
47740-86 26 16



Spoon

Pcs/pz 36 - ml. 15

art. mm.
47740118 90x28x12



Square Savarins

Pcs/pz 35 - ml. 45

art. mm.
47740108 56x56x24



Square Savarins

Pcs/pz 24 - ml. 100

art. mm.
47740-96 70x70x30

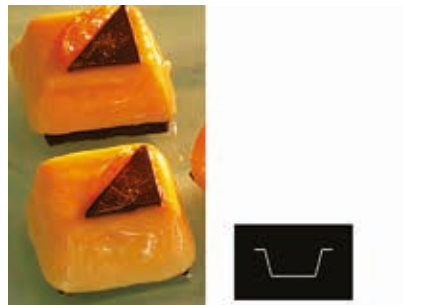

Squares

Pcs/pz 35 - ml. 60

art. mm.
47740117 56x56x24

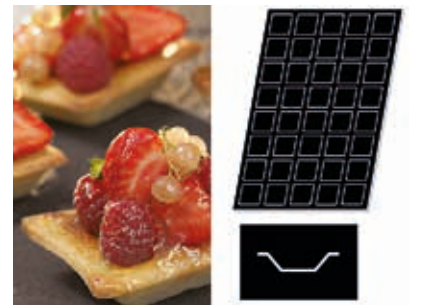

Squares

Pcs/pz 40 - ml. 40

art. mm.
47740110 60x60x15



St Honoré crown

Pcs/pz 6 - ml. 260

art. Ø mm. h.
47740129 150 26



Stars

Pcs/pz 24 - ml. 35

art. mm.
47740-88 80x65x15

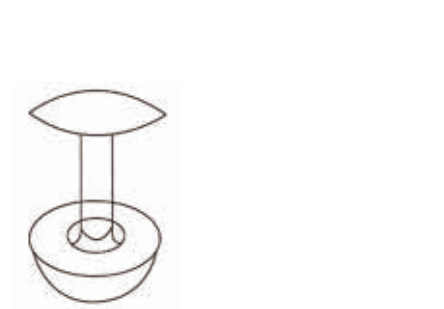

Tagliapasta - Pastry cutter

art.
47740-AA

Fits references: 07-08-34-31
Adatto agli stampi: 07-08-34-31



Tarte tatin

Pcs/pz 15 - ml. 135

art. Ø mm. h.
47740-73 82 30



Teddy bear

Pcs/pz 18 - ml. 80

art. mm.
47740-53 90x55x20



Triangles

Pcs/pz 80 - ml. 7

art. mm.
47740-35 48x41x10



Various petits-fours

Pcs/pz 60

art. h.
47740134 22



Zaphire

Pcs/pz 54 - ml. 17

art. mm.
47740112 40x40x24



Zaphire

Pcs/pz 24 - ml. 75

art. mm.
47740113 70x70x35



Spoon pastry cutter

Tagliapasta cucchiaino

art.
47740-AB



Star pastry cutter

Tagliapasta stella

art.
47740-AC



Heart pastry cutter

Tagliapasta cuore

art.
47740-AD



Pearls

Pcs/pz 15 - ml. 100

art. Ø mm. h.
47743-65 73 40



Stars

Pcs/pz 8 - ml. 95

art. mm.
47741121 90x75x25



Small half sphere

Pcs/pz 5 - ml. 63

art. Ø mm. h.
47741-76 23 11

FLEXIPAN GN 1/1

FLEXIPAN CM 40X30

FLEXIPAN CM 40X30



Small hearts

Pcs/pz 30 - ml. 15

art. mm.

47741-78 52x49x10

FLEXIPAN CM 40X30



Half sphere flat

Pcs/pz 48 - ml. 10

art. Ø mm. h.

47741-77 30 13

FLEXIPAN CM 40X30



Cylinder

Pcs/pz 24 - ml. 148

art. Ø mm. h.

47744-30 70 40

FLEXIPAT CM 60x40



Cube

Pcs/pz 96 - ml. 17

art. mm.

47744-32 30x30x20

FLEXIPAT CM 60x40



Kougloff

Pcs/pz 24 - ml. 150

art. Ø mm. h.

47744-31 80 54

FLEXIPAT CM 60x40



Basic chic

Pcs/pz 24 - ml. 130

art. mm.

47744-33 70x70x34

FLEXIPAT CM 60x40



Diamond

Pcs/pz 24 - ml. 100

art. Ø mm. h.

47744-34 79 40

FLEXIPAT CM 60x40

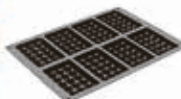

Waffels

Pcs/pz 8 - ml. 100

art. mm.

47741-38 80x127x15

FLEXIPAT CM 40X30



Fingers

Pcs/pz 24 - ml. 54

art. mm.

47741-37 129x28x15

FLEXIPAT CM 40X30



Buche

art. mm. ml.

47744-80 280x85x70 140



Half sphere

art. Ø mm. h. ml.

47744-81 180 90 1600



Flexiform desserts

art. mm. ml.

47744-58 253x253x45 222



Flexiform desserts

art. mm. ml.
 47744-59 600x400x50 980



Flexiform desserts

art. mm.
 47744-48 480x280x13
 47744-60 555x360x10
 47744-62 555x360x20



Rosette

art. Ø mm.
 47744-10 240



Venetian cane

art. mm.
 47744-19 555x360



Labyrinth

art. mm.
 47744-21 600x400



Bubbles

art. mm.
 47744-36 600x400



Mikado

art. mm.
 47744-37 600x400



Snowflake

art. Ø mm.
 47744-63 240



Buche2

art. mm.
 47744-70 275x185



Buche1

art. mm.
 47744-71 275x185

SILFORM CM 60X40
PUFFS - BIGNE' - WINDBEUTEL - CHOUX - BOLLOS



This range has been developed especially for cream puffs dough. The pre-formed shapes make easy obtaining perfect, regular and same size cream puffs. Neither greasing the sheet nor spiking the dough is required before baking. The non-stick property of the material allows an easy and perfect extraction of the pastries. The base of the puff will be clear and plain for a perfect stability.

Supporto alveolare Silform® per cottura di pasta bignè. Questa gamma è stata sviluppata in particolare per la pasta di bignè. Grazie alle impronte preformate, preparare bignè uguali e regolari diventa facile. Non è più indispensabile nè spennellare con tuorlo nè forare la pasta. Grazie alle proprietà antiaderenti del Silform®, l'estrazione è impeccabile. La base del bignè sarà chiara e netta conferendogli così una perfetta stabilità. Silform® for Choux Pastry.



Paris-Brest

art.	Ø mm.	h.	ml.	pcs/pz
41760-27	80	15	50	24



Oval choux

art.	mm.	ml.	pcs/pz
41760-26	90x60x15	56	25



Baby choux

art.	Ø mm.	h.	ml.	pcs/pz
41760-22	30	5	4	59



Big choux

art.	Ø mm.	h.	ml.	pcs/pz
41759-01	67	15	48	28



Eclairs - Right handed. Per ambidestri

art.	mm.	ml.	pcs/pz
41760-20	125x25x5	15	18



Eclairs - Left handed. Per mancini.

art.	mm.	ml.	pcs/pz
41760-21	125x25x5	15	18

SILFORM CM 60X40
BREAD - PANE - BROT - PAIN - PAN

Silform® baking sheets size 60x40 cm. Especially studied for breads, nonstick and ideal for a variety of small bread shapes: round, hot-dogs rolls, soft rolls, submarines, hamburger buns, sandwiches, etc., etc. Thanks to their perforated texture, the heat transfer is optimized, allowing unique crunchy and coloration. Can be used indifferently on aluminum baking trays or grids.

Supporti di cottura Silform® dim. 60x40 cm. Specifici per pane, antiaderenti, ideali per panini tondi, hot dogs, panini al latte, per hamburger, baguettes, ecc., ecc. La loro texture perforata ottimizza il trasferimento del calore per una perfetta croccantezza e doratura del prodotto. Si utilizzano indifferenteemente su teglie in alluminio o griglie.



Round shapes/Rotondi

Pcs/pz 28 - ml. 48

art.	Ø mm.	h. mm.
41759-01	67	15



Round shapes/Rotondi

Pcs/pz 24 - ml. 65

art.	Ø mm.	h. mm.
41759-02	75	17



Round shapes/Rotondi

Pcs/pz 24 - ml. 65

art.	Ø mm.	h. mm.
41759-03	79	15



Round shapes/Rotondi

Pcs/pz 15 - ml. 140

art.	Ø mm.	h. mm.
41759-05	102	20



Round shapes/Rotondi

Pcs/pz 11 - ml. 175

art.	Ø mm.	h. mm.
41759-09	125	16



Oval shapes/Ovali

Pcs/pz 24 - ml. 80

art.	mm.	h. mm.
41760-02	95x40	30



Oval shapes/Ovali

Pcs/pz 18

art.	mm.	h. mm.
41760-05	155x41	25



Oval shapes/Ovali

Pcs/pz 12

art.	mm.	h. mm.
41760-06	169x64	30



Oval shapes/Ovali

Pcs/pz 8

art.	mm.	h. mm.
41760-08	259x64	30



Oval shapes/Ovali

Pcs/pz 6

art.	mm.	h. mm.
41760-09	299x60	30



French loaves perforated sheet, silicone coated

Teglia alluminio forato, siliconata
Pariserbrotblech, Silikon-beschichtet
Plaque perforée pain parisien, siliconée
Placa pan perforada, siliconada

art.	cm.	pcs/pz
41758-53	53x32	4
41758-60	60x40	5
41758-65	65x43	6
41758-85	85x43	6

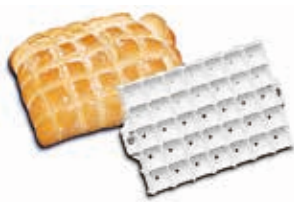

Bread mould

Stampo per pane
Brot-Ausstechforme
Découpoir à pain
Cortador para pan

art.	cm.
47041-01	14x10



Bread mould

Stampo per pane
Brot-Ausstechforme
Découpoir à pain
Cortador para pan

art.	cm.
47041-02	14x10



Bread mould

Stampo per pane
Brot-Ausstechforme
Découpoir à pain
Cortador para pan

art.	Ø cm.
47041-03	12,5



Bread mould

Stampo per pane
Brot-Ausstechforme
Découpoir à pain
Cortador para pan

art.	cm.
47041-04	16,5x8,5



Bread mould

Stampo per pane
Brot-Ausstechforme
Découpoir à pain
Cortador para pan

art.	Ø cm.
47041-05	12,5



Bread mould

Stampo per pane
Brot-Ausstechforme
Découpoir à pain
Cortador para pan

art.	Ø cm.
47041-06	8



Bread mould

Stampo per pane
Brot-Ausstechforme
Découpoir à pain
Cortador para pan

art.	Ø cm.
47041-07	8



Bread mould

Stampo per pane
Brot-Ausstechforme
Découpoir à pain
Cortador para pan

art.	Ø cm.
47041-08	8



Bread mould

Stampo per pane
Brot-Ausstechforme
Découpoir à pain
Cortador para pan

art.	Ø cm.
47041-15	8



Kaiser bread marker
 Marcatore pane Kaiser
 Kaiserbrot Stempel
 Empreinte pain Kaiser
 Molde pan Kaiser

art.
47040-00



Bread brush
 Spazzola pane
 Brot-Bürste
 Brosse à pain
 Cepillo para pan

art.	l. cm.
42614-04	24,5
42614-05	32,0
42614-06	41,0
42614-07	46,0



Disposable baker's blades
 Lame panettiere usa e getta
 Einweg-Bäcker-Klingen
 Incisette boulanger jetables
 Láminas del panadero desechables

art.	l. cm.	pcs/pz
48290-10	12	10

SS



PE

Bread basket
 Cesta pane
 Brot-Korb
 Corbeille à pain
 Cesta pan

art.	cm.	lt.
44982-04	57x36x34	40
44982-06	66x45x35	60
44982-10	78x52x40	100



PP

Bread proofing basket
 Cestino impasto
 Brotformen
 Banneton
 Molde para pan

art.	Ø cm.	h.	gr.	col.
47042-19	19	7,5	500	●
47042-22	22	9,3	1000	●
47042-25	25	9,0	1500	●



PP

Bread proofing basket
 Cestino impasto
 Brotformen
 Banneton
 Molde para pan

art.	cm.	gr.	col.
47043-27	27x12x6,5	500	●
47043-35	35x13x7,2	1000	●
47043-42	42x14x7,5	1500	●



ETHNIC CUISINE CUCINA ETNICA

ASIA FUSION



The images of the products in this chapter reflect the characteristics of the products in the warehouse. However, they have to be considered mainly for illustrative purposes only. Although we make every effort to display the products accurately, the products received may vary slightly from those images. In any case the changes are intended as improvements and do not alter the function, nor lessen the utility of the product.

Tutte le foto degli articoli presenti nel capitolo rispecchiano il più possibile le caratteristiche dei prodotti presenti in magazzino. Teniamo comunque a precisare che le immagini sono indicative ed i prodotti reali potrebbero differire nei colori e nelle dimensioni. Le variazioni sono in ogni caso migliorative e tali da non alterare la natura e la funzionalità del prodotto stesso.



Withstands temperatures from -20°C to +70°C.

Termoresistenti da -20°C a +70°C.



Rice bowl
Coppa riso
Reistasse
Bol à riz
Copa arroz

art.	Ø cm.	h.	lt.	col.
44463-11	11	7	0,3	●



Tray
Vassoio
Platte
Plateau
Placa

art.	dim. cm.	h.	col.
44464-23	23,5x7,5	2	●



Tray
Vassoio
Platte
Plateau
Placa

art.	dim. cm.	h.	col.
44465-24	24,5x6,5	1,5	●



Bowl
Ciotola
Schüssel
Bol
Bol Ensalada

art.	Ø cm.	h.	col.
44452-31	31	8,5	○
44452B31	31	8,5	●



Bowl
Ciotola
Schüssel
Bol
Bol Ensalada

art.	dim. cm.	h.	col.
44453-14	14,5x12	5,5	○
44453B14	14,5x12	5,5	●



Bowl
Ciotola
Schüssel
Bol
Bol Ensalada

art.	Ø cm.	h.	col.
44454-11	11,5	4	○
44454B11	11,5	4	●



Bowl
Ciotola
Schüssel
Bol
Bol Ensalada

art.	dim. cm.	h.	col.
44455-09	9x7	2,5	○
44455B09	9x7	2,5	●



Bowl
Ciotola
Schüssel
Bol
Bol Ensalada

art.	dim. cm.	h.	col.
44456-14	14x9	2,5	○
44456B14	14x9	2,5	●



Bowl
Ciotola
Schüssel
Bol
Bol Ensalada

art.	dim. cm.	h.	col.
44457-32	32,5x14	4	○
44457B32	32,5x14	4	●



Tray
Vassoio
Platte
Plateau
Placa

art.	dim. cm.	h.	col.
44461-20	20x20	4,5	○
44461B20	20x20	4,5	●



Bowl
Ciotola
Schüssel
Bol

Bol Ensalada

art.	dim. cm.	h.	col.
44450-21	21x21	11	○
44450B21	21x21	11	●



Bowl
Ciotola
Schüssel
Bol

Bol Ensalada

art.	dim. cm.	h.	col.
44450-12	12x12	4	○
44450B12	12x12	4	●



Bowl
Ciotola
Schüssel
Bol

Bol Ensalada

art.	dim. cm.	h.	col.
44450-17	17,5x17,5	7	○
44450B17	17,5x17,5	7	●



Tray
Vassoio
Platte
Plateau
Placa

art.	dim. cm.	h.	col.
44451-22	22x12	3	○
44451B22	22x12	3	●



Tray
Vassoio
Platte
Plateau
Placa

art.	dim. cm.	h.	col.
44462-25	25x25	5,5	○
44462B25	25x25	5,5	●



Dish
Piatto
Teller
Assiette
Plato

art.	Ø cm.	h.	col.
44459-28	28	3	○
44459B28	28	3	●



Bowl
Ciotola
Schüssel
Bol

Bol Ensalada

art.	dim. cm.	h.	col.
44450-11	11x10	3	○
44450B11	11x10	3	●



Bowl
Ciotola
Schüssel
Bol

Bol Ensalada

art.	dim. cm.	h.	col.
44450-13	13x11	3,5	○
44450B13	13x11	3,5	●



Bowl
Ciotola
Schüssel
Bol

Bol Ensalada

art.	dim. cm.	h.	col.
44450-15	17,5x15,5	5,5	○
44450B15	17,5x15,5	5,5	●



Tray
Vassoio
Platte
Plateau
Placa

art.	dim. cm.	h.	col.
44450-23	22x23,5	5,5	○
44450B23	22x23,5	5,5	●





MF

Soba choko cup with cover

Tazza soba choko con coperchio
Soba Choko-Schale mit Deckel
Coupe soba choko avec couvercle
Taza soba choko con tapa

art. Ø cm. h.
49655-47 8,5 6,5



MF

Soup/rice bowl with lid

Ciotola riso con coperchio
Reisschüssel mit Deckel
Bol à riz avec couvercle
Bol arroz con tapa

art. Ø cm. h.
49655-34 10 10

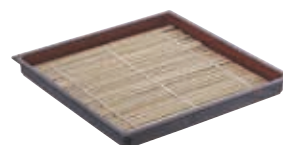

MF

Zaru soba tray

Vassoio zarusoba
Zaru Soba-Tablett
Plateau zaru soba
Bandeja zaru soba

art. dim. cm.
49655-48 19,5x19,5



MF

Towel tray

Vassoio portatovagliolo
Handtuch-Tablett
Plateau à serviette
Bandeja servilleta

art. dim. cm.
49655-46 17x7



MF

Double Sided Tray

Vassoio reversibile
Platte, doppelseitig
Plateau double face
Bandeja doble cara

art. dim. cm.
49655-20 35x31

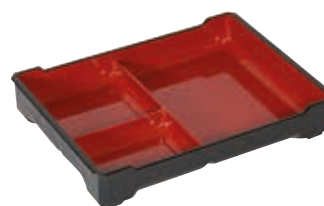

MF

Bento tray

Vassoio bento
Bento-Platte
Plateau à bento
Bandeja bento

art. dim. cm.
49655-36 22x16x3,5



MF

Bento box with lid

Scatola bento con coperchio
Bento-Box mit Deckel
Boîte à bento avec couvercle
Caja bento con tapa

art. dim. cm.
49655-44 30x24



MF

Bento box with lid

Scatola bento con coperchio
Bento-Box mit Deckel
Boîte à bento avec couvercle
Caja bento con tapa

art. dim. cm.
49655-37 24x24x5,5



MF

Sushi serving dish

Piatto a servire
Sushi-Servierteller
Plat à sushi
Plato para sushi

art. Ø cm. h.
49655-21 22 5,5
49655-22 25 6,0
49655-23 28 6,0



MF

Sushi-sashimi bridge

Ponte per sushi e sashimi
Sushi-Brücke
Sushi et sashimi pont
Puente para sushi-sashimi

art. dim. cm.
49655-41 28x13,5x6



B

Sushi geta board

Tagliere sushi
Sushibrett
Planche à sushi
Tabla para sushi

art. dim. cm.
49655-24 24x15x3



MF

Hand roll stand, laquered
Supporto per temaki, laccato
Temaki-Ständer
Support pour temaki
Soporte para temaki

art. dim. cm.
49655-32 18x9,5x8



W

Hand roll stand
Supporto per temaki
Temaki-Ständer
Support pour temaki
Soporte para temaki

art. dim. cm.
49655-31 18x9x8,5



MF

Sushi-sashimi boat
Barca per sushi e sashimi
Sushi-Sashimi-Boot
Bateau sushi et sashimi
Barco sushi-sashimi

art. dim. cm.
49655-45 28x13,5x6



B

Sushi-sashimi boat
Barca per sushi e sashimi
Sushi-Sashimi-Boot
Bateau sushi et sashimi
Barco sushi-sashimi

art. dim. cm.
49655-29 34x12x10,5



MF

Soup spoon
Cucchiaio brodo
Suppenlöffel
Cuiller à soupe
Cuchara sopa

art. dim. cm. col.
44850-13 13,5x4,5 ○
44850B13 13,5x4,5 ●



MF

Soup spoon
Cucchiaio brodo
Suppenlöffel
Cuiller à soupe
Cuchara sopa

art. l. cm.
49655-35 14,5



PR

Sauce pourer
Salsiera
Sauciere
Saucière
Salsera

art. dim. cm. lt. U. Pack
67305-57 7x11 0,20 6
67308-57 5x4 0,03 6



PR

Flat plate
Piattino piano
Teller flach
Petite assiette plate
Platillo llano

art. dim. cm. U. Pack
67303Q80 9x9 6
67303Q81 12x12 6



PR

Deep plate
Piattino fondo
Teller tief
Petite assiette creuse
Platillo hondo

art. dim. cm. U. Pack
67303Q82 9x9 6
67303Q83 12x12 6



PR

Small dish
Ciotolina
Schale
Petite assiette
Platillo

art. dim. cm. U. Pack
67303M01 9x7x3 6



PR

Small dish
Piattino
Schale
Petite assiette
Platillo

art. Ø cm. h. U. Pack
67303M04 10,5 2 6



PR

Small dish

Piattino
Schale
Petite assiette
Platillo

art.	dim. cm.	U. Pack
67303M02	14x7x2	6



PR

Small dish

Ciotolina
Schale
Petite assiette
Platillo

art.	Ø cm.	h.	U. Pack
67303M03	10	2	6



PR

Small dish

Ciotolina
Schale
Petite assiette
Platillo

art.	dim. cm.	U. Pack
67303M05	11x8	6
67303M06	16x11	6



PR

Chinese spoon

Cucchiaio cinese
Löffel
Cuillère chinoise
Cucharita

art.	l. cm.	U. Pack
67303M07	13	12



PR

Sake jug

Caraffa sake
Sakekrug
Carafe à sake
Jarra sake

art.	Ø cm.	h.	ml.	col.
49655-25	5,2	13,5	120	○
49655-42	5,7	18,0	250	○



PR

Sake jug

Caraffa sake
Sakekrug
Carafe à sake
Jarra sake

art.	Ø cm.	h.	ml.	col.
49655-57	5,2	13,5	130	●
49655-58	5,7	18,0	230	●



PR

Sake cup

Coppetta sake
Sakebecher
Coupe à sake
Copa sake

art.	Ø cm.	h.	ml.
49655-26	4,5	4,5	40



PR

Sake cup

Coppetta sake
Sakebecher
Coupe à sake
Copa sake

art.	Ø cm.	h.	ml.	col.
49655-43	4,5	5,5	40	○
49655-60	4,5	5,5	40	●



PR

Sake cup

Coppetta sake
Sakebecher
Coupe à sake
Copa sake

art.	Ø cm.	h.
49655-56	5	4



PR

Sake jug

Caraffa sake
Sakekrug
Carafe à sake
Jarra sake

art.	Ø cm.	h.
49655-55	6	9,5



PR

Sake warmer

Riscalda sake
Sakewärmer
Réchaud à sake
Calentador de sake

art.	Ø cm.	h.
49655-54	9,5	9



PR

Soy pot

Vaso soia
Sojakrug
Carafe soja sauce
Jarra soja

art.	Ø cm.	h.
49655-52	12	7,5



PR

Soy pot
Vaso soia
Sojakrug
Carafe soja sauce
Jarra soja

art.	Ø cm.	h.
49655-51	6,5	7



PR

Soy pot
Vaso soia
Sojakrug
Carafe soja sauce
Jarra soja

art.	Ø cm.	h.	ml.
49655-53	5,5	8,5	130



PR

Chopstick rest
Supporto bacchette cinesi
Ess-Stäbchen Ablage
Pose baguettes
Soporte para palillos

art.	dim. cm.	col.
49655-27	4,5x3	●
49655-28	4,5x3	○



PR

Chopstick rest
Supporto bacchette cinesi
Ess-Stäbchen Ablage
Pose baguettes
Soporte para palillos

art.	dim. cm.
49655-61	6x1,5



MF

Chopsticks
Bacchette cinesi
Ess-Stäbchen
Baguettes
Palillos

art.	l. cm.	pcs/pz
49658-01	27	2x 10



MF

Chopsticks
Bacchette cinesi
Ess-Stäbchen
Baguettes
Palillos

art.	l. cm.	pcs/pz
49658-02	27	2x 10



B

Disposable chopsticks
Bacchette monouso
Einweg Ess-Stäbchen
Baguettes jetables
Palillos desechables

art.	l. cm.	pcs/pz
48300-29	21	2x 50



B

Disposable chopsticks
Bacchette monouso
Einweg Ess-Stäbchen
Baguettes jetables
Palillos desechables

art.	l. cm.	pcs/pz
49627-22	24	2x 100



Japanese chopsticks, assorted colors
Bacchette giapponesi, colori assortiti
Japanische-Ess-Stäbchen
Baguettes japonaises
Palillos japoneses

art.	l. cm.	pcs/pz
49628-00	24	2x 1



SS

Japanese chopsticks
Bacchette giapponesi
Japanische-Ess-Stäbchen
Baguettes japonaises
Palillos japoneses

art.	l. cm.	pcs/pz
49655-30	23	2x 5



B

Noshikushi skewers
Spiedini noshikushi
Noshikushi Spieße
Brochettes noshikushi
Pinchos noshikushi

art.	l. cm.	pcs/pz
48300-42	10,5	100



B

Tepokushi skewers
Spiedini tepokushi
Tepokushi Spieße
Brochettes tepokushi
Pinchos tepokushi

art.	l. cm.	pcs/pz
48300-43	9	100
48300-33	15	100



B

Sushi mat

Stuoietta
Sushi-Matte
Natte à rouler les sushis
Mantelín para sushi

art. dim. cm.
49626-00 24x24



B

Sushi mat

Stuoietta
Sushi-Matte
Natte à rouler les sushis
Mantelín para sushi

art. dim. cm.
49626-02 27x27



Sushi-maki set 3 pcs

Kit 3 pz per sushi-maki
Sushi-Maki-Satz 3 Stk
Kit 3 pcs pour réaliser les sushi-maki
Juego 3 pz para sushi-maki

art. dim. cm.
49655-02 26x7,5x6



Maki roll mould

Stampo per maki
Maki-Ausstechform
Moule à maki
Molde para maki

art. dim. cm.
49655-10 20,5x4x4



Nigiri mould

Stampo per nigiri
Nigiri-Ausstechform
Moule à nigiri
Molde para nigiri

art. dim. cm.
49655-16 16x6x2,5



MF

Rice spoon

Cucchiaio riso
Reislöffel
Cuiller à riz
Cuchara arroz

art. dim. cm.
49655-03 22x7



B

Steamer

Cuocivapore
Dampfgarer
Panier vapeur
Vaporera

art. Ø cm.
49603-15 16
49603-20 20
49603-25 25
49603-30 30
49603-40 40
49603-50 50



B

Steamer

Cuocivapore
Dampfgarer
Panier vapeur
Vaporera

art. dim. cm.
49656-15 15,2x15,2
49656-16 16,5x16,5
49656-20 20,3x20,3

2 bodies + 1 cover. – 2 ceste + 1 coperchio.



W

Hangiri/sushi rice tub

Vasca riso hangiri
Hangiri/Sushi-Reis-Wanne
Cuve à riz sushi/hangiri
Barril arroz sushi/hangiri

art.	Ø cm.
49655-49	45
49655-50	60



Wok with grid and cover, 3-ply

Wok c/griglia e coperchio, 3-ply
Wok mit Rost und Deckel, 3-ply
Wok avec grille et couvercle, 3-ply
Wok con rejilla y tapa, 3-ply

art.	Ø cm.	h.
12529-32	32	8



Steel wok pan

Wok, ferro
Wok-Eisenpfanne
Poêle chinoise, acier
Wok, hierro

art.	Ø cm.	h.
11713-32	32	10
11713-40	40	11



Steel wok pan

Wok, ferro
Wok-Eisenpfanne
Poêle chinoise, acier
Wok, hierro

art.	Ø cm.	h.
49604-31	30,5	9
49604-36	35,5	11
49604-41	40,5	12



Non stick wok

Wok antiaderente
Wok-Pfanne, nichttaftend
Poêle chinoise, anti-adhérente
Wok, antiaderente

art.	Ø cm.
49612-30	30,5
49612-33	33,0



Wok stand, chromed

Base per wok, cromata
Fuss für Wokpfanne, verchromt
Base pour wok, chromée
Base para Wok, cromada

art.	Ø cm.	h.
49600-00	20-25	5,5



Tempura rack, chromed

Griglia per tempura, cromata
Tempura-Rost, verchromt
Grille à tempura, chromée
Rejilla para tempura, cromada

art.	Ø cm.
49613-30	30,5
49613-33	33,0
49613-35	35,5

Flat bottom. – Fondo piano.



Steel wok pan

Wok, ferro
Wok-Eisenpfanne
Poêle chinoise, acier
Wok, hierro

art.	Ø cm.	h.
49605-46	45,5	14,0
49605-61	61,0	18,5
49605-71	71,0	22,0



Wok lid, aluminum

Coperchio per wok, alluminio
Wok-Deckel, Aluminium
Couvercle pour poêle chinoise, alu
Tapa para wok, aluminio

art.	Ø cm.	h.
49602-25	25	4
49602-30	29	4
49602-33	33	4
49602-35	35	4



SS

Wok stand

Base per wok
Fuss für Wokpfanne
Base pour wok
Base para Wok

art.	Ø cm.
11953-22	22



Pot with lid and trivet

Casseruola con coperchio e sottopentola
Kasserolle+Deckel+Untersetzer
Casserole avec couvercle et sous-plat
Cacerola con tapa y posavasos

art.	Ø cm.
49655-63	17
49655-64	21
49655-65	15



Toban skillet

Padella Toban
Toban-Pfanne
Poêle Toban
Sartén Toban

art.	Ø cm.
49655-40	19





Balti pan

Padella balti/karahi
Balti-Pfanne
Poêle balti
Sartén balti

art.	Ø cm.
49657-15	15,2
49657-20	20,3
49657-25	25,4



Balti pan with wood base

Padella balti base legno
Balti-Pfanne mit Holz-Basis
Poêle balti avec base en bois
Sartén balti base de madera

art.	Ø cm.
49656-02	15,2



Steel fry pan

Padella per friggere, ferro
Frittier-Eisenpfanne
Tuile à frire, acier
Sartén freidora, hierro

art.	Ø cm.	h.	lt.
41707-32	32	9,8	6,0
41707-36	36	11,0	8,8
41707-40	40	13,4	12,2
41707-45	45	15,0	17,3
41707-50	50	17,6	23,5



Wire basket, tinned

Cestello per friggere, stagnato
Frittier-Rost, verzinkt
Grille à frire, étamée
Cesta escurrefrito, estañada

art.	Ø cm.	h.
41708-32	32	11,0
41708-36	36	11,5
41708-40	40	12,4
41708-45	45	15,5
41708-50	50	16,5



Japanese omelettes pan, non-stick

Padella omelette, antiaderente
Japanische Omelette Pfanne mit
Antihafbeschichtung
Poêle à omelettes, revêtement anti-adhésif
Sartén antiadherente para tortillas japonesas

art.	dim. cm.
49655-38	22x24x3,5



Steel tawa pan

Padella tawa, ferro
Tawa-Eisenpfanne
Poêle tawa, acier
Sartén tawa, hierro

art.	Ø cm.
49614-28	28

Used in Indian cooking, for chapattis and anything that needs quick cooking at high temperatures. – Utilizzate nella cucina indiana, per focacce e tutto ciò che ha bisogno di cottura rapida ad alta temperatura.



SS

Steamer

Cuocivapore
Dampf-Kocher
Cuisseur à vapeur
Cuscusera

art.	Ø cm.	h.
49606-51	51	14
49606-00	51	14
49606-01	51	20



-01

-00

-51



Scoop

Portionatore
Portionierer
Cuiller
Racionador

art.
49616S01
49616B01



Chinese hot pot, aluminium

Pentola cinese, alluminio
Chinese- Suppentopf, Alu
Marmite chinoise, alu
Olla chino, aluminio

art.	Ø cm.	h.
49616-22	22	17
49616-24	24	20
49616-26	26	22



Clay pot

Casseruola terracotta
Tontopf
Pot d'argile
Olla de barro

art.	Ø cm.	h.	Kg.
49632-24	23	10	1,5
49632-32	32	16	2,7



Clay pot

Casseruola terracotta
Tontopf
Pot d'argile
Olla de barro

art.	Ø cm.	h.	Kg.
49633-22	22	10	0,75
49633-24	24	12	1,35



Cast iron sizzler platter with wood

Piatto ghisa con vassoio legno
Gusseisenplatte mit Holzbrett
Plat en fonte avec planche bois
Fuente hierro fundido con tabla madera

art.	dim. cm.
49615-01	33,5x22



Cast iron sizzler platter with wood

Piatto ghisa con vassoio legno
Gusseisenplatte mit Holzbrett
Plat en fonte avec planche bois
Fuente hierro fundido con tabla madera

art.	dim. cm.
44223S19	12,5x19



Mortar and pestle

Mortaio e pestello
Mörser und Stößel
Mortier et pilon
Mortero y pistilo

art.	Ø cm.	h.	Kg.
49618-12	9	10,5	2,6
49618-15	11	12,0	4,1
49618-18	14	13,5	5,8



Wasabi grater

Grattugia per wasabi
Wasabi-Raffel
Rape à wasabi
Rallador para wasabi

art.	dim. cm.
42555-11	11x7,5



Oil pourer

Oliera
Ölkanne
Huilière
Alcuza

art.	ml.
41780-05	500
41780-07	750
41780-09	1000

SS



Noodle strainer

Colapasta
Nudeln-Sieb
Passoire
Colador

art.	Ø cm.	h.
49601-14	14	13

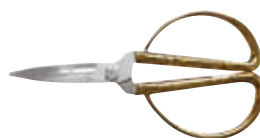

Meat scissors

Forbice carni
Fleischschere
Ciseaux à viande
Tijeras para carne

art.	dim. cm.
49636-00	17



Duck fur pincer

Pinza per anatra
Ente Fell Zange
Pince à canard
Pinza pato

art.	l. cm.
49637-00	15

Stainless steel and natural wood.
Inox e legno naturale.



Fish scaler

Squamapesce
Fischentschupper
Ecailleur à poisson
Escamador

art.	l. cm.
49638-00	22



Fry basket, coarse mesh

Schiumarola fritto, rete grossa
Frittierkorb
Panier de friture
Cesta para freír

art.	Ø cm.
49607-15	15,0
49607-20	20,0
49607-25	25,5
49607-30	30,5

Bamboo handle, stainless steel mesh.
Manico bamboo, rete inox.



Fry basket, fine mesh

Schiumarola fritto, rete fine
Frittierkorb
Panier de friture
Cesta para freír

art.	Ø cm.
49608-15	15,0
49608-20	20,0
49608-25	25,5
49608-30	30,5
49608-35	35,5

Bamboo handle, stainless steel mesh.
Manico bamboo, rete inox.



SS

Skimmer

Schiumarola
Schaumlöffel
Ecumoire
Espumadera

art.	Ø cm.	l. cm.
49617-23	24	45
49617-25	26	46
49617-30	30	50



Ladle

Mestolo
Schöpflöffel
Louche
Cacillo

art.	Ø cm.
49609-12	11,8
49609-14	13,8

Stainless steel and natural wood.
Inox e legno naturale.



Spatula

Paletta
Teigschäber
Spatule
Espátula

art.	dim. cm.
49610-11	11x10,2
49610-14	13,3x12

Stainless steel and natural wood.
Inox e legno naturale.



B

Cooking chopsticks

Bastoncini per cucinare
Kochstäbchen
Baguettes de cuisine
Palillos para cocinar

art.	l. cm.
49629-45	45

Disposable. – Monouso.



B

Wok brush

Pennello per wok
Wok-Pinsel
Pinceaux à wok
Pincel para wok

art.	l. cm.
49634-00	25,5



Wooden handled wok brush

Spazzola per wok
Wok-Bürste, Holzgriff
Brosse à wok, manche bois
Cepillo para wok, mango madera

art.	l. cm.
49635-00	27,5



PIZZA

ETHNIC CUISINE
CUCINA ETNICA





SS

Oil pourer

Oliera
Ölkanne
Huilière
Alcuza

art.	lt.
41780-05	0,50
41780-07	0,75
41780-09	1,00



Oil pourer, copper

Oliera, rame
Ölkanne, Kupfer
Huilière, cuivre
Alcuza, cobre

art.	h. cm.	lt.
41781-05	23,0	0,50
41781-10	27,0	1,00
41781-15	31,5	1,50

Tinned inside. – Interno stagnato.



Pizza peel, aluminum

Pala pizza, alluminio
Pizzaschaufel, Aluminum
Pelle à pizza, aluminum
Pala pizza, aluminio

art.	Ø cm.	l. cm.	gr.
11701-02	32	150	736
11701-06	37	150	870
11701-10	41	150	1226
11701-13	45	150	1460
11701-16	50	150	1604



Pizza peel, aluminum

Pala pizza, alluminio
Pizzaschaufel, Aluminum
Pelle à pizza, aluminum
Pala pizza, aluminio

art.	cm.	l. cm.	gr.
11702-02	32x32	150	784
11702-06	37x37	150	894
11702-10	41x41	150	1246
11702-16	50x50	150	1694



Perforated pizza peel, aluminum

Pala pizza forata, alluminio
Pizzaschaufel, gelocht, Aluminum
Pelle à pizza perforée, aluminum
Pala pizza perforada, aluminio

art.	cm.	l. cm.	gr.
11704-02	32x32	150	700
11704-06	37x37	150	816
11704-13	45x45	150	1250
11704-16	50x50	150	1409



SS

Pizza peel, small

Palettino
Pizzaschaufel, klein
Petite pelle à pizza
Pala pizza, pequeña

art.	Ø cm.	l. cm.	gr.
11705-02	17	150	780
11705-06	20	150	846
11705-10	23	150	938
11705-14	26	150	984



SS

Perforated pizza peel, small

Palettino forato
Pizzaschaufel, gelocht, klein
Petite pelle à pizza perforée
Pala pizza perforada, pequeña

art.	Ø cm.	l. cm.	gr.
11706-02	17	150	770
11706-06	20	150	830
11706-10	23	150	912
11706-14	26	150	954



Oven pizza peel, aluminum

Pala per infornare, alluminio
Back-Pizzaschaufel, Aluminum
Pelle à enfourner, aluminum
Pala para hornear, aluminio

art.	cm.	l. cm.	gr.
41765-32	32x32	150	1200
41765-37	37x37	150	1400
41765-41	41x41	150	1500
41765-45	45x45	150	1600
41765-50	50x50	150	1700



SS

Oven pizza peel

Pala per infornare
Back-Pizzaschaufel
Pelle à enfourner
Pala para hornear

art.	Ø cm.	l. cm.	gr.
41735-29	29	150	870

Aluminum handle. – Manico alluminio.



Oven pizza peel, aluminum
Pala per infornare, alluminio
Back-Pizzaschaufel, Aluminium
Pelle à enfourner, aluminium
Pala para hornear, aluminio

art.	cm.	l. cm.	gr.
41736-32	32x30	150	954



Perforated pizza peel, small
Palettino forato
Pizzaschaufel, gelocht, klein
Petite pelle à pizza perforée
Pala pizza perforada, pequeña

art.	Ø cm.	l. cm.	gr.
41737-17	17	150	890
41737-20	20	150	910
41737-23	23	150	960

SS



Pizza peel, small
Palettino
Pizzaschaufel, klein
Petite pelle à pizza
Pala pizza, pequeña

art.	Ø cm.	l. cm.	gr.
41738-17	17	150	905
41738-20	20	150	975
41738-23	23	150	1030

SS



Pizza peel, small, aluminum
Palettino, alluminio
Pizzaschaufel, klein, Aluminium
Petite pelle à pizza, aluminium
Pala pizza, pequeña, aluminio

art.	Ø cm.	l. cm.	gr.
41735-20	20	150	800



Pizza peel
Pala pizza
Pizzaschaufel
Pelle à enfourner
Pala pizza

art.	Ø cm.	l. cm.
41764-28	28	125
41764-33	33	200
41764-40	40	200

W



Ash shovel
Paletta cenere
Asche-Schaufel
Pelle à cendres
Paleta recogedar cenizas

art.	cm.	l. cm.
41768-21	21x31	173

SS



Rake
Rastrello
Harke
Râteau
Rastrillo

art.	cm.	l. cm.
41768-22	24x10	150

SS



Adjustable brush
Spazzola orientabile
Drehbare Bürste
Brosse orientable
Cepillo orientable

art.	cm.	l. cm.
41767-20	20x6,5	155

Brass bristles. – Setole ottone.



Adjustable brush
Spazzola orientabile
Drehbare Bürste
Brosse orientable
Cepillo orientable

art.	cm.	l. cm.
41766-27	27x7	150

Brass bristles. – Setole ottone.



Adjustable brush
Spazzola orientabile
Drehbare Bürste
Brosse orientable
Cepillo orientable

art.	cm.	l. cm.
41766-16	16x5	150

Brass bristles. – Setole ottone.



Adjustable brush
Spazzola orientabile
Drehbare Bürste
Brosse orientable
Cepillo orientable

art.	cm.	l. cm.
41766-14	14x7	150



Adjustable brush
Spazzola orientabile
Drehbare Bürste
Brosse orientable
Cepillo orientable

art.	cm.	l. cm.
41739-20	20x6,6	150



Brush for grill cleaning

Spazzola per griglia, setole in acciaio
Grillenbürste mit Stahlborsten
Brosser pour grille avec soies en acier
Cepillo para parrilla con cerdas de acero

art. cm.
41740-00 27x4x15



SS

Support for peels

Poggia pala pizza
Schaufelträger
Support pour pelles à pizza
Portapala para palas

art. cm. Kg.
41769-36 41x16x39 3,0
41769-50 53x16x39 3,5



Small pizza peel wall rack, aluminum

Portapalletto da muro, alluminio
Pizzaschaufel-Wandgestell, Aluminum
Support mural petite pelle, aluminum
Soporte mural de pala pizza, aluminio

art.
41769-02



Pizza peel wall rack, aluminum

Appendi pala da muro, alluminio
Pizzaschaufel-Wandgestell, Aluminum
Support mural pour pelle, aluminum
Soporte mural de pala pizza, aluminio

art.
41769-01



Double-sided brush

Spazzola bi-facciale
Bürste Deidseitig
Brosse double face
Cepillo doble

art. l. cm.
41761-02 100



SS

Pizza peel rack

Porta pale
Ständer für Schaufeln
Support pour pelles
Soporte para pala

art. h. cm. Kg.
41769-00 172 14



SS

Pizza peel, marble base

Porta pale, base marmo
Ständer für Schaufeln
Support pour pelles
Soporte para pala

art. cm.
41769G00 25x35x180

Supplied WITHOUT peels. – Fornito SENZA pale.



SS

Adjustable brush

Spazzola orientabile
Drehbare Bürste
Brosse orientable
Cepillo orientable

art. cm. l. cm.
41767G20 20x6 160

Brass bristles. – Setole ottone.



SS

Pizza peel, aluminum

Pala pizza, alluminio
Pizzaschaufel, Aluminum
Pelle à pizza, aluminum
Pala pizza, aluminio

art. cm. l. cm.
41704G33 33x33 150
41704G36 36x36 150



SS

Perforated pizza peel, small

Palettino forato
Pizzaschaufel, gelocht, klein
Petite pelle à pizza perforée
Pala pizza perforada, pequeña

art.	Ø cm.	l. cm.
41737G20	20	150
41737G23	23	150



SS

Pan gripper

Pinza per teglie
Pizzablech-Zange
Pince à plaques
Pinza fuente horns

art.	l. cm.
42822-00	23



SS

Pan gripper

Pinza per teglie
Pizzablech-Zange
Pince à plaques
Pinza fuente horns

art.	l. cm.
18323-00	23



SS

Pizza cutter

Tronchetto tagliapizza
Pizzaschneider
Coupe-pizza
Cortador de pizza

art.	Ø cm.	l. cm.
18324-00	13,5	19



SS

Divisible pizza scissors

Forbice pizza smontabile
Pizzaschere, teilbar
Ciseaux à pizza, divisible
Tijeras para pizza desmontables

art.	l. cm.
18276-00	25



SS

Pizza wheel

Rotella taglia pizza
Pizzaschneider
Roulette à pizza
Ruleta cortapizzas

art.	Ø cm.
18324-10	10



SS

Pizza knife

Coltello per pizzaiolo
Pizzamesser
Couteau à pizza
Cuchillo para pizza

art.	l. cm.
48280-45	23



SS

Farinata knife

Coltello per farinata
Farinata Messer
Couteau à farinata
Cuchillo farinata

art.	l. cm.
42830-08	8



SS

Perforated spatula

Paletta triangolare, forata
Palette, gelocht
Palette perforée
Pala triangular perforada

art.	cm.
18301-01	12x15



SS

Spatula

Paletta triangolare
Palette
Palette
Pala triangular

art.	cm.
18301-02	12x15



Peel with handle, aluminum

Pala manicata, alluminio
Schaufel mit Griff, Aluminum
Pelle avec manche, alu
Pala con mango, aluminio

art.	Ø cm.
42826-32	32
42826-37	37



SS

Perforated peel with handle

Pala manicata, forata
Schaufel mit Griff, gelocht
Pelle perforée avec manche
Pala con mango, perforada

art.	cm.
18302-01	22x18



SS

Peel with handle
Pala manicata
Schaufel mit Griff
Pelle avec manche
Pala con mango

art. cm.
18302-02 22x18



W

Round tray
Vassoio rotondo
Buchenholzbrett, rund
Plateau ronde
Bandeja redonda

art. Ø cm. h. cm.
41774-33 33 1,2

Beech wood. – Faggio.



W

Cutting board 1 portion
Tagliere monoporzione
Einzelportion Tablett
Planche mono-portion
Tabla monoporción

art. cm.
41775-34 34x20x1,2

Beech wood. – Faggio.



Pizza delivery bag
Borsa isotermica
Thermischetasche
Sac thermique
Bolsa térmica

art. cm.
44960-06 35x35x20

For 5 pcs ø 33 cm. – Per 5 pizze ø 33 cm.



Pizza delivery bag
Borsa isotermica
Thermischetasche
Sac thermique
Bolsa térmica

art. cm.
44960-04 46x44x19,5

For 5 pcs ø 30 or 4 ø 33 cm.
Per 5 pizze ø 30 o 4 ø 33 cm.



PP

Insulated container
Contentitore isoteramico
Thermobehälter
Conteneur isotherme
Contenedor isotérmico

art. cm. lt.
44961-03 42x42x34,5 36

With steam release system.
Con sistema di rilascio del vapore.



PP

SS

Dough scraper, flexible
Tagliapasta flessibile
Abstecher, flexibele
Raclette flexible
Cortapastas flexible

art. cm.
18501-02 12x9,5



PP

SS

Dough scraper
Tagliapasta
Abstecher
Raclette
Cortapastas

art. cm.
18501-01 12x16
18501-03 13,5x10
18501-04 12x9,5



PP

SS

Dough scraper
Raschia
Teigschäber
Raclette
Rasqueta

art. cm.
18501-05 11x19,5



PP

SS

Dough scraper
Raschia
Teigschäber
Raclette
Rasqueta

art. cm.
18502-18 18x9



PP

SS

Dough scraper
Raschia
Teigschäber
Raclette
Rasqueta

art. cm.
18503-12 12x10



PP

SS

Dough scraper
Raschia
Teigschäber
Raclette
Rasqueta

art. cm.
18504-15 15x7,5



PP
SS

Dough scraper

Raschia
Teigschäber
Raclette
Rasqueta

art. cm.
18520-15 15x6



PA+
plus

Pizza ladle, flat bottom

Mestolo pizza, fondo piatto
Schöpflöffel, flachboden
Louche fond plat
Cacillo fondo plano

art. Ø cm. l. cm.
12968-10 10 27



PS

Dough cutter

Tagliapasta
Teigschäber
Raclette
Rascador

art. cm.
47621-11 10x24

Shock and scratchproof material. Do not use on heat sources. – Materiale antiurto e antigraffio. Non usare su fonti di calore.



PS

Dough cutter

Tagliapasta
Teigschäber
Raclette
Rascador

art. cm.
47621-12 13,5x14,5

Shock and scratchproof material. Do not use on heat sources. – Materiale antiurto e antigraffio. Non usare su fonti di calore.



PE

Dough box

Contenitore per impasti
Behälter für Pizzateig
Récipient à pétrissage
Contenedor para masa de pizza

art. cm. lt.
41762-07 60x40x7,5 14
41762-09 60x40x9,5 19
41762-13 60x40x13 26



PE

Cover for dough box

Coperchio per contenitore
Deckel für Pizzateig-Behälter
Couvercle pour récipient à pétrissage
Tapa para contenedor

art. cm.
41763-00 60x40



Pizza screen, aluminum

Retina pizza, alluminio
Pizzanetzscheibe, Aluminum
Toile à pizza, aluminium
Red para pizza, aluminio

art. cm.
41734-60 60x40



Pizza screen, aluminum

Retina pizza, alluminio
Pizzanetzscheibe, Aluminum
Toile à pizza, aluminium
Red para pizza, aluminio

art. Ø cm.
41727-28 28
41727-30 30
41727-33 33
41727-36 36
41727-40 40

Without seam. – Senza giunzione.



Pizza screen, aluminum

Retina pizza, alluminio
Pizzanetzscheibe, Aluminum
Toile à pizza, aluminium
Red para pizza, aluminio

art. Ø cm.
41727-45 45
41727-50 50
41727-55 55
41727-60 60

Without seam. – Senza giunzione.



SS

Pizza screen rack

Rastrelliera per retine
Pizzanetzscheiben-Träger
Etagère à toiles
Rack para red para pizza

art. cm.
41771-96 23x35,6

Suitable for 96 screens.
Può contenere 96 retine.



SS

Pizza pan rack

Rastelliera per teglie pizza
Pizzableche-Träger
Etagère pour plaques à pizza
Rack para placas pizza

art. cm.
41770-15 30,5x30,5x70

Rails h.3,5 cm. for sheets up to Ø 36 cm.
Distanza piani cm 3,5, per teglie max ø 36 cm.



Baking sheet, alusteel

Teglia forno, acciaio alluminato
Backblech mit Aluminumüberzug
Plaque à pizza, tôle aluminée
Placa pizza, acero aluminizado

art.	Ø cm.	h. cm.	U. Pack
11739-20	20	2,5	10
11739-24	24	2,5	10
11739-28	28	2,5	10
11739-32	32	2,5	10



Pizza sheet, heavy blue steel

Teglia pizza, ferro blu pesante
Pizzablech, Blaublech, Schwerausführung
Plaque à pizza, tôle forte bleuie
Placa pizza, hierro pesante

art.	Ø cm.	h. cm.	U. Pack
11744-20	20	2,5	10
11744-24	24	2,5	10
11744-28	28	2,5	10
11744-32	32	2,5	10

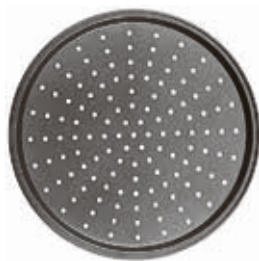

Pizza sheet, perforated, non stick coated

Teglia pizza forata, antiaderente
Pizzablech, gelocht, beschichtet
Plaque à pizza perforée, anti-adhésive
Placa pizza perforada, antiaderente

art.	Ø cm.	h. cm.
41729-30	30	1,3
41729-34	34	1,3



Pizza sheet double non stick-coating

Teglia pizza, antiaderente a 2 strati
Pizzablech mit Doppel-Beschichtung
Plaque à pizza, double revêtement
Placa pizza antiaderente, 2 capas

art.	Ø cm.	h. cm.	U. Pack
11741-20	20	2,5	5
11741-24	24	2,5	5
11741-26	26	2,5	5
11741-28	28	2,5	5
11741-32	32	2,5	5

Heat resistant up to 280°C. – Resistente a 280 °C.



Pizzasheet, blue steel

Teglia pizza, ferro blu
Pizza-Blaublech
Plaque à pizza, tôle bleuie
Placa pizza, hierro

art.	Ø cm.	h. cm.	U. Pack
11740-14	14	2,5	5
11740-16	16	2,5	5
11740-18	18	2,5	5
11740-20	20	2,5	5
11740-22	22	2,5	5
11740-24	24	2,5	5



Pizzasheet, blue steel

Teglia pizza, ferro blu
Pizza-Blaublech
Plaque à pizza, tôle bleuie
Placa pizza, hierro

art.	Ø cm.	h. cm.	U. Pack
11740-26	26	2,5	5
11740-28	28	2,5	5
11740-30	30	2,5	5
11740-32	32	2,5	5
11740-36	36	2,5	5
11740-40	40	2,5	5



Pizzasheet, blue steel

Teglia pizza, ferro blu
Pizza-Blaublech
Plaque à pizza, tôle bleuie
Placa pizza, hierro

art.	Ø cm.	h. cm.	U. Pack
11742-16	16	3,5	10
11742-18	18	3,5	10
11742-20	20	3,5	10
11742-22	22	3,5	10
11742-24	24	3,5	10
11742-26	26	3,5	10
11742-28	28	3,5	10



Pizzasheet, blue steel

Teglia pizza, ferro blu
Pizza-Blaublech
Plaque à pizza, tôle bleuie
Placa pizza, hierro

art.	Ø cm.	h. cm.	U. Pack
11742-30	30	3,5	10
11742-32	32	3,5	5
11742-36	36	3,5	5
11742-40	40	3,5	5
11742-45	45	4,0	5
11742-50	50	4,0	5
11742-60	60	4,0	5



Baking sheet, blue steel, rectangular

Teglia rettangolare, ferro blu
Blaublech, rechteckig
Plaque rectangulaire, tôle bleuie
Placa rectangular, hierro

art.	cm.	h. cm.
41745-30	30x23	3
41745-35	35x28	3
41745-40	40x30	3
41745-50	50x35	3
41745-60	60x40	3
41745-65	65x45	3



Baking sheet, alusteel

Teglia, alluminata
Backblech, Aluminumüberzug
Plaque rectangulaire, tôle aluminitée
Placa rectangular, acero aluminizado

art.	cm.	h. cm.
41746-60	60x40	2



Baking sheet, alusteel

Teglia, alluminata
Backblech, Aluminumüberzug
Plaque rectangulaire, tôle aluminitée
Placa rectangular, acero aluminizado

art.	cm.	h. cm.
41751-30	30x23	3
41751-35	35x28	3
41751-40	40x30	3
41751-50	50x35	3
41751-60	60x40	3
41751-65	65x45	3



Baking sheet, aluminum, perforated

Teglia forata, alluminio
Backblech, gelocht, Aluminium
Plaque perforée, aluminium
Placa perforada, aluminio

art.	cm.	h. cm.
41756-30	30x40	1
41756-32	32,5x53	1
41756-53	53x65	1
41756-60	60x40	1

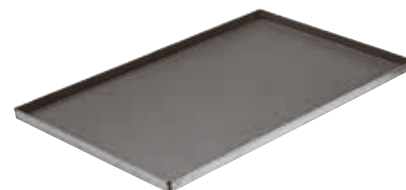

Baking sheet, non stick coated

Teglia antiaderente
Blech mit Antihftbeschichtung
Plaque avec revêtement anti-adhésif
Placa antiadherente

art.	cm.	h. cm.
41747-60	60x40	2



Baking sheet, non stick coated

Teglia antiaderente
Blech mit Antihftbeschichtung
Plaque avec revêtement anti-adhésif
Placa antiadherente

art.	Ø cm.	GN	pcs/pz
41755-11	12,5	1/1	6



Baking sheet, alusteel

Teglia, alluminata
Backblech, Aluminumüberzug
Plaque, tôle aluminitée
Placa, acero aluminizado

art.	Ø cm.	cm.	pcs/pz
41752-08	14	60x40	8
41752-12	12	60x40	12
41752-24	12	60x80	24



COFFEE SHOP CAFFETTERIA

BAR HAPPY HOUR





Nitro Whip
Sifone nitro
Nitrobereiter
Siphon à nitro
Sifón para Nitro

art.	lt.	des.
41452N10	1	
41452N16		16 chargers/ricariche

Nitro Brew is on one of the fastest growing trends in the coffee business. Offer Nitro Coffee, Nitro Tea, and Nitro Cocktails to delight your guests table/barside. Adding Nitrogen (N2) to cold brew coffee and cocktails initiates a spectacular cascading effect, making the beverage unique, attractive, and personal. Nitrogen creates a velvety creamy texture and a long lasting foamy head for brews and cocktails. – Infusi Nitro è una delle tendenze in rapida crescita nel settore del caffè. Offri Nitro Caffè, Nitro Te e Nitro Cocktails per deliziare i tuoi ospiti. Aggiungendo l'azoto (N2) per preparare caffè e cocktail a freddo, viene avviato uno spettacolare effetto a cascata, rendendo la bevanda unica, attraente e personale. L'azoto crea una consistenza vellutata e cremosa e una spuma di lunga durata per infusi e cocktail.





Set of 10 stencils, plastic

Kit 10 mascherine, plastica
Satz 10 Masken, kunststoff
Set 10 pcs masques, plastique
Juego 10 máscaras, plástico

art.	Ø cm.	h. cm.	lt.
47859-01	10	16	0,25



Set of 10 stencils, plastic

Kit 10 mascherine, plastica
Satz 10 Masken, kunststoff
Set 10 pcs masques, plastique
Juego 10 máscaras, plástico

art.	Ø cm.
47859-02	10



Set of 4 stencils, plastic

Kit 4 mascherine, plastica
Satz 4 Masken, kunststoff
Set 4 pcs masques, plastique
Juego 4 máscaras, plástico

art.	Ø cm.
47859-03	10



Cocoa duster kit

Kit spargicacao
Kakaostreuer-Set
Set glacière à cacao
Juego dosificador cacao

art.	Ø cm.	h. cm.
42923-07	6,5	13



Cocoa dredger

Spargicacao
Kakaostreuer
Saupoudreuse
Especiero

art.	Ø cm.	h. cm.	ml.
41607-00	5,5	7,5	160



Sugar pourer

Spargizucchero
Zuckerstreuer
Saupoudreuse
Especiero

art.	Ø cm.	Ø mm.	ml.
47023-01	7	1,5	300
47023-02	7	2,5	300
47023-03	7	5	300
47023-04	7	mesh	300



Sugar pourer

Spargizucchero
Zuckerstreuer
Sucrier
Dispensador azúcar

art.	Ø cm.	h. cm.	ml.
41525-01	8	15	250



Sugar pourer

Spargizucchero
Zuckerstreuer
Sucrier
Dispensador azúcar

art.	Ø cm.	h. cm.	ml.
42920-02	7,5	13,5	320



Sugar pourer

Spargizucchero
Zuckerstreuer
Sucrier
Dispensador azúcar

art.	Ø cm.	h. cm.	ml.
41645-00	7,5	17	320



Honey/cream dispenser

Dosatore miele/cremiera
Sahne-/Honigkännchen
Doseur pour miel/lait
Dosificador para miel/leche

art.	Ø cm.	h. cm.	ml.
41525-00	8,5	13,5	300



Milk pot with lid

Lattiera con coperchio
Milchgießer mit Deckel
Pot à lait avec couvercle
Jarra leche con tapa

art.	lt.
66303-01	0,15
66303-03	0,30
66303-06	0,60



Cappuccino milk pot

Lattiera cappuccino
Capuccino-Milchkanne
Pot à cappuccino
Jarra cappuccino

art.	lt.
66307-06	0,6
66307-09	0,9
66307-12	1,2



SS

Spoon holder
Porta cucchiaini
Kaffeelöffelbehälter
Porte cuillères
Porta cucharas

art.	Ø cm.	h. cm.
66313-03	6	9



SS

Straw holder
Porta cannuce
Röhrchenbehälter
Porte chalumeaux
Porta canutillos

art.	Ø cm.	h. cm.
66313-06	8	12



SS

Sugar packet holder
Portabustine zucchero
Zuckertütenschale
Conteneur à sucre
Contenedor sobres azúcar

art.	dim. cm.
66374-00	13x6x4



SS

Sugar packet holder
Portabustine zucchero
Zuckertütenschale
Conteneur à sucre
Contenedor sobres azúcar

art.	dim. cm.
44104-15	9x7,5x5

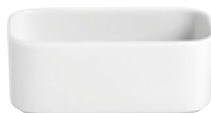

PR

Sugar packet holder
Portabustine zucchero
Zuckertütenschale
Conteneur à sucre
Contenedor sobres azúcar

art.	dim. cm.
67303-64	11x6x4



Sugar packet holder
Portabustine zucchero
Zuckertütenschale
Conteneur à sucre
Contenedor sobres azúcar

art.	dim. cm.	col.
44104-01	8,5x6,5x5	●
44104-02	8,5x6,5x5	○



AY

Tea-box
Scatola portabustine thè
Teebox
Boîte à sachets de thé
Caja para bolsitas de tè

art.	dim. cm.
41614-22	22x17x9



W

Tea-box
Scatola portabustine thè
Teebox
Boîte à sachets de thé
Caja para bolsitas de tè

art.	dim. cm.
41614-33	33,5x20x9
41614-35	31x28x9



W

Tea-box
Scatola portabustine thè
Teebox
Boîte à sachets de thé
Caja para bolsitas de tè

art.	dim. cm.
41614-34	33,5x20x9
41614-36	31x28x9



SS

Napkin holder
Portatovaglioli
Serviettenhalter
Porte serviettes
Servilletero

art.	dim. cm.
66391-00	10x3x8



SS

Napkin holder
Portatovaglioli
Serviettenhalter
Porte serviettes
Servilletero

art.	dim. cm.
41602-00	17x3x7



SS

Napkin dispenser
Portatovaglioli
Serviettenspender
Porte serviettes
Servilletero

art.	dim. cm.
41601-17	8,5x11x12,5



Napkin holder, chrome plated wire

Portatovaglioli in filo cromato
Serviettenhalter, Metall verchromt
Porte-serviettes en fil chromé
Servilletero en hilo cromado

art. dim. cm.
41617-05 19x19x6,5



Napkin holder, chrome plated wire

Portatovaglioli in filo cromato
Serviettenhalter, Metall verchromt
Porte-serviettes en fil chromé
Servilletero en hilo cromado

art. dim. cm.
41617-15 19x19x19



Napkin holder, chrome plated wire

Portatovaglioli in filo cromato
Serviettenhalter, Metall verchromt
Porte-serviettes en fil chromé
Servilletero en hilo cromado

art. dim. cm.
41618-14 14x14x6,5



Cash tray, 18 Cr s/s

Vassoio conto, inox 18 Cr
Rechnungstablett, Edelstahl 18 Cr
Plateau porte-monnaie, inox 18 Cr
Bandeja cuentas, acero 18 Cr

art. dim. cm.
66318-19 19x14
66318-22 22x15



Pastry stand 2 tiers, chromed

Alzata dolci 2 piani, cromata
Gebäckständer, 2-stufig, verchromt
Serveur muet 2 étages, chromé
Soporte dulces 2 niveles, cromado

art. Ø cm. h. cm.
42975-02 11-14 16



PMMA

Showcase

Vetrina brioches
Vitrine für Brioches
Vitrine brioches
Vitrina brioches

art. dim. cm.
41472-32 37x31x31



ABS

SAN



Showcase

Vetrina da banco
Vitrine für Verkaufstheke
Vitrine à comptoir
Vitrina

art. dim. cm.
47091-01 44x32x20,5

Double side opening. Equipped with s/s tray and coolers. – Apertura doppio fronte. Con vassoio inox e eutettici.



ABS

SAN



Showcase, 2 tiers

Vetrina da banco, 2 piani
Vitrine für Verkaufstheke, doppeldecker
Vitrine à comptoir, 2 étages
Vitrina, doble

art. dim. cm.
47091-02 44x32x44

Double side opening. Equipped with s/s trays and coolers. – Apertura doppio fronte. Con vassoi inox e eutettici.



AY

PP

Sweet box

Contentitore universale
Universalbox
Boîte à comptoir
Exibidor

art. dim. cm.
47090-23 23x14,5x15



MF

Cake tray
Piatto torta
Tortenplatte
Plat gâteau
Bandeja pasteles

art.	Ø cm.	h. cm.
44845-31	31	4



SS

Swivel cake stand
Alzata torta girevole
Tortenplatte drehbar
Gueridon pâtissier tournante
Pedestal giratorio para tartas

art.	Ø cm.	h. cm.
47101-31	30,5	9



PS

Dome cover
Cloche
Abdeckhaube
Cloche
Campana

art.	Ø cm.	h. cm.
41414-30	30	9,5

Per art/for item: 44845-31/47101-31



MF

Round dish
Piatto tondo
Platte, rund
Plat rond
Bandeja redonda

art.	Ø cm.	h. cm.
44845-38	38	2



SAN

Roll-top cover
Coperchio roll-top
Rolltophaube
Couvercle roll-top
Campana roll-top

art.	Ø cm.	h. cm.
41447-38	38	20

Per art/for item: 44845-38, 44475-78/79



SS

Cake stand
Alzata torta
Tortenplatte
Gueridon pâtissier
Pedestal para tartas

art.	Ø cm.	h. cm.
41538-30	30	5



SS

Cake stand
Alzata torta
Tortenplatte
Gueridon pâtissier
Pedestal para tartas

art.	Ø cm.	h. cm.
47099-30	30	10



SS

Cake stand
Alzata torta
Tortenplatte
Gueridon pâtissier
Pedestal para tartas

art.	Ø cm.	h. cm.
41537-34	34,5	13,5



PS

Dome cover
Campana
Frischhalte-Haube
Cloche
Cubierta

art.	Ø cm.	h. cm.
41537-33	33	12,5

Per art/for item: 41537-34



MF

Cake stand
Alzata torta
Tortenplatte
Gueridon pâtissier
Pedestal para tartas

art.	Ø cm.	h. cm.
44873-08	31	8



MF

Cake stand
Alzata torta
Tortenplatte
Gueridon pâtissier
Pedestal para tartas

art.	Ø cm.	h. cm.
44873-16	31	16





Cake stand
Alzata torta
Tortenplatte
Gueridon pâtissier
Pedestal para tartas

art. dim. cm.
44874-08 31x31x8



Cake stand
Alzata torta
Tortenplatte
Gueridon pâtissier
Pedestal para tartas

art. dim. cm.
44874-16 31x31x16



Dome cover
Campana
Haube
Cloche
Campana

art. Ø cm. h. cm.
41414-31 30 22

Per art/for item: 44873-08/-16, 44475-79, 41586-33, 41587-32, 44845-31, 47101-31.



Cake platter
Piatto torta
Tortenplatte
Plat gâteau
Bandeja pasteles

art. Ø cm. h. cm.
44475-76 30,0 2
44475-78 38,5 2



Cake platter
Piatto torta
Tortenplatte
Plat gâteau
Bandeja pasteles

art. Ø cm. h. cm.
44475-77 30,0 2
44475-79 38,5 2



Cake stand
Alzata torta
Tortenplatte
Gueridon pâtissier
Pedestal para tartas

art. Ø cm. h. cm.
44475-80 11,5-15 10,5
44475-82 11,5-15 20,0



Cake stand
Alzata torta
Tortenplatte
Gueridon pâtissier
Pedestal para tartas

art. Ø cm. h. cm.
44475-81 21-15 10,5
44475-83 21-15 20,0

ICE CREAM GELATERIA

BAR HAPPY HOUR





MS

Ice cream cup
Coppa gelato
Eisbecher
Coupe à glace
Copa helado

art.	h. cm.	lt.	U. Pack
44942-12	6,5	0,26	6



MS

Ice cream cup
Coppa gelato
Eisbecher
Coupe à glace
Copa helado

art.	h. cm.	lt.	U. Pack
44942-11	11	0,38	6



MS

Ice cream cup
Coppa gelato
Eisbecher
Coupe à glace
Copa helado

art.	h. cm.	lt.	U. Pack
44942-10	16	0,25	6



MS

Ice cream cup
Coppa gelato
Eisbecher
Coupe à glace
Copa helado

art.	Ø cm.	h. cm.	U. Pack
44942-06	10	10	6



MS

Ice cream cup
Coppa gelato
Eisbecher
Coupe à glace
Copa helado

art.	Ø cm.	h. cm.	U. Pack
44942-07	9	19	6



MF

Gourmet bowl
Ciotolina Gourmet
Schälchen Gourmet
Bol Gourmet
Bol Gourmet

art.	Ø cm.	h. cm.	ml.
44466-07	7	6	50



MF

Gourmet tray
Vassoio Gourmet
Tablett Gourmet
Plateau Gourmet
Bandeja Gourmet

art.	dim. cm.
44466-30	30,5x9,5x2,5



SS

Ice cream cone holder
Porta coni
Eiswaffelständer
Porte cornets à glace
Soporte para cucuruchos

art.	dim. cm.
41472-01	20x9,5x8,5



SS

Ice cream cone holder
Porta coni
Eiswaffelständer
Porte cornets à glace
Soporte para cucuruchos

art.	Ø cm.	h. cm.
41472-04	16,5	14



PMMA

Waffle case
Contenitore per cialde
Waffelbehälter
Porte gaufres
Contenedor para waffles

art.	dim. cm.
41472-21	22x26x12



PMMA

Spoon case
Contenitore per palette
Eislöffelbehälter
Porte cuillères à glace
Contenedor para cucharitas

art.	dim. cm.
41472-20	19x12,5x14



PMMA

Straws case
Contenitore per cannucce
Strohalmbehälter
Porte chalumeaux
Contenedor para pajitas

art.	dim. cm.
41472-22	26x17x22



PMMA

Revolving cones dispenser

Porta coni girevole
Eiswaffelspender, drehbar
Porte-cornets pivotant
Distributor giratorio de cucuruchos

art.	Ø cm.	h. cm.
41472-15	24	78



PMMA

Cone holder, front opening

Porta coni, apertura frontale
Eiswaffelspender mit Frontöffnung
Porte cornets à glace, ouverture frontale
Porta cucuruchos, abertura frontal

art.	dim. cm.
41472-16	11x13x50



PS

Disposable cups

Coppette monouso
Schale, einweg
Bols, jetables
Bols, desechables

art.	Ø cm.	h. cm.	ml.
48365-09	9	7,5	175

Pcs/Conf. 100 pz.



PS

Disposable cups

Coppette monouso
Schale, einweg
Bols, jetables
Bols, desechables

art.	Ø cm.	h. cm.	ml.
48366-09	9	7,5	125

Pcs/Conf. 100 pz.



PS

Small glasses, disposable

Bicchierini monouso
Klein Glass, einweg
Petite verres, jetables
Vasos pequeños, desechables

art.	Ø cm.	h. cm.	ml.
48353-01	8,5	6,5	120

Pcs/Conf. 100 pz.



PS

Small glasses, disposable

Bicchierini monouso
Klein Glass, einweg
Petite verres, jetables
Vasos pequeños, desechables

art.	Ø cm.	h. cm.	ml.
48354-01	4	8,5	70

Pcs/Conf. 100 pz.



PS

Small glasses, disposable

Bicchierini monouso
Klein Glass, einweg
Petite verres, jetables
Vasos pequeños, desechables

art.	Ø cm.	h. cm.	ml.
48350-01	4,2	6,5	50
48350-02	5,0	6,5	80
48350-03	5,5	7,0	100
48350-04	6,0	9,0	160

Pcs/Conf. 100 pz.



PS

Small glasses, disposable

Bicchierini monouso
Klein Glass, einweg
Petite verres, jetables
Vasos pequeños, desechables

art.	dim. cm.	ml.
48351-01	4x4x5,5	50
48351-02	5x5x7	100
48351-03	5,5x5,5x8	150

Pcs/Conf. 100 pz.



PS

Small glasses, disposable

Bicchierini monouso
Klein Glass, einweg
Petite verres, jetables
Vasos pequeños, desechables

art.	Ø cm.	h. cm.	ml.
48352-01	6,5	5,5	70
48352-02	7,0	6,7	120
48352-03	7,5	7,3	150

Pcs/Conf. 100 pz.



SS

Ice cream container

Bacinella per gelato
Eisbehälter
Réipient à glace
Cubeta helado

art.	dim. cm.	lt.
41471-12	36x16,5x12	5,0
41471-15	36x16,5x15	6,5
41471-17	36x16,5x17	7,5



PMMA

Lid for ice cream container

Coperchio per bacinella gelato
Deckel für Eisbehälter
Couvercle pour réipient à glace
Tapa para cubeta helado

art.	dim. cm.
41471-00	36x16,5



SS

Ice cream container

Bacinella per gelato
Eisbehälter
Réipient à glace
Cubeta helado

art.	dim. cm.	lt.
41486-08	36x25x8	5
41486-12	36x25x12	8
41486-15	36x25x15	10



SS

Ice cream container

Bacinella per gelato
Eisbehälter
Réceptient à glace
Cubeta helado

art.	dim. cm.	lt.
41487-12	26x16x12	3,5
41487-15	26x16x15	4,1
41487-17	26x16x17	4,5



NEW

SS

Ice cream basin

Carapina
Eisbehälter
Réceptient à glace
Cubeta helado

art.	Ø cm.	h. cm.	lt.
41489-20	20	25	7,3



SS

Ice cream server

Spatola gelato
Eisspachtel
Palette à glace
Paleta helados

art.	l. cm.	col.
41475-00	27	○
41475-01	27	●
41475-03	27	●
41475-04	27	●
41475-05	27	●



Ice-dipper

Spatola gelato
Eisdipper
Cuillère à glace
Cuchara helados

art.	Ø mm.	lt.
41468-20	55	1/20
41468-24	50	1/24

With liquid heat conductor in the handle.
Con liquido conduttore nel manico.



Ice-dipper

Spatola gelato
Eisdipper
Cuillère à glace
Cuchara helados

art.	Ø mm.	lt.
41469-20	55	1/20
41469-24	50	1/24

With liquid heat conductor in the handle.
Con liquido conduttore nel manico.



SS

Ice cream scoop

Porzionatore
Eisportionierer
Cuillère à glace
Racionador de helado

art.	Ø mm.	lt.
41476-50	50	1/24

Non slip handle. – Manico antiscivolo.



SS

Ice cream scoop

Porzionatore
Eisportionierer
Cuillère à glace
Racionador de helado

art.	Ø mm.	lt.
41473-31	30	1/100
41473-39	38	1/65
41473-44	43	1/50
41473-50	50	1/24
41473-56	55	1/20
41473-62	60	1/14
41473-66	66	1/12



NEW

Ice cream scoop

Porzionatore
Eisportionierer
Cuillère à glace
Racionador de helado

art.	Ø mm.	lt.
41488-45	45	1/40
41488-47	47	1/36
41488-50	50	1/30
41488-53	53	1/24

Nylon, fiberglass. Stainless steel mechanism.
Meccanismo in acciaio inox.



SS

Oval ice cream scoop

Porzionatore ovale
Eisportionierer, oval
Cuillère à glace ovale
Racionador de helado oval

art.	Ø mm.	lt.
41474-00	60	1/30



SS

Triangle ice cream scoop

Porzionatore triangolare
Eisportionierer, dreieckig
Cuillère à glace triangle
Racionador de helado triangular

art.	lt.
41474-02	1/30



SS

Professional cream whipper

Sifone panna professionale
Profi-Sahnebereiter
Siphon à crème professionnel
Sifón montador de nata profesional

art.	lt.
41451-05	0,5
41451-10	1,0



Cream chargers, 10-pcs set

Ricariche panna montata, conf. 10 pezzi
10-Stk. Sahnekapseln-Packung
Capsules à crème Chantilly, set 10 pièces
Cápsulas para nata, 10 piezas

art.
41450-AA

Contains N2O under pressure.
Contiene N2O sotto pressione.



SS

GOURMET-Cream whipper

Sifone panna
Sahnebereiter
Siphon à crème
Sifón para nata montada

art.	lt.
41458-02	0,25
41458-05	0,50
41458-10	1,00

Heat resistant silicone gasket. Keep warm in bain marie up to 75°C. – Guarnizione in silicone resistente al calore. Tenere a bagnomaria max. a 75°C.



SS

THERMO-Cream whipper

Sifone termico
Thermo-Sahnebereiter
Siphon à crème, isotherme
Sifón isotérmico

art.	lt.
41455T55	0,5

Double-walled, insulated bottle: keeps creations cold for 8 hours and hot for 3 hours, dishwasher-safe. – Bottiglia termica, mantiene le preparazioni in caldo fino a 3 ore e a freddo fino a 8 ore.



SS

THERMO SPRESS-Cream whipper

Sifone termico
Thermo-Sahnebereiter
Siphon à crème, isotherme
Sifón isotérmico

art.	h. cm.	lt.
41459-10	35	1

Double-walled, insulated bottle, keeps creations cold for 8 hours and hot for 3 hours. – Bottiglia termica, mantiene le preparazioni in caldo fino a 3 ore e a freddo fino a 8 ore, lavabile in lavastoviglie.



SS

PROFI-Cream whipper

Sifone panna
Sahnebereiter
Siphon à crème
Sifón para nata montada

art.	lt.
41460-05	0,5
41460-10	1,0

Only for cold preparations.
Solo per preparazioni fredde.



Decorating tips, 3-pcs set

Bocchette, set 3 pezzi
Dekorationstüllen, 3er Set
Douilles de décoration, 3 pièces
Boquillas de decoración, 3 piezas

art.
41455-BC



SS

Decorating tips, 3-pcs set

Bocchette, set 3 pezzi
Dekorationstüllen, 3er Set
Douilles de décoration, 3 pièces
Boquillas de decoración, 3 piezas

art.
41458-23



Decorating tips and adapter

Bocchette decoro e adattatore
Dekorationstüllen-Set u. Adapter
Douilles de décoration et adaptateur
Boquillas de decoración y adaptador

art. 41458-24



Injector needles

Iniettori/siringhe decoro
Nadeltüllen
Aiguilles d'injection
Boquillas de aguja

art. 41458-21

SS



Heat protector, silicone

Protezione in silicone
Silikonhülle
Housse en silicone
Protección de silucona

art.	lt.
41458-50	0,5
41458-51	1,0



SS

Funnel and sieve

Imbuto e colino
Trichter und Sieb
Entonnoir et tamis
Embudo y tamiz

art. 41458-11



Cream chargers, PROFESSIONAL

Ricariche panna montata, PROFESSIONAL
Sahnekapseln-Packung, PROFESSIONAL
Capsules à crème Chantilly, PROFESSIONAL
Cápsulas para nata, PROFESSIONAL

art.	pcs/pz
41455-CA	24
41455-CB	50

Filled with 8,4 g of N₂O (E942, nitrous oxide).
Contenuto: 8,4 g di N₂O (E942 protossido di azoto).



Kit rapid infusion

Kit di infusione rapida
Rapid Infusion Set
Paquet rapid infusion
Rapid infusion set

art. 41458-25

Enables a liquid to be infused with different flavors in the shortest possible time. First, combine aromatic solids (e.g. herbs, spices, fruit) and a liquid (e.g. alcohol, oil, water, vinegar) in the whipper then apply pressure into it using a cream charger. – Permette di infondere un liquido con sapori diversi in tempo rapido. Unire gli aromi solidi (erbe, spezie, frutta, ecc.) con il liquido (alcol, olio, acqua, aceto, ecc.) nel sifone ed immettere una carica per panna.



COCKTAIL BAR

BAR HAPPY HOUR

Paderno offers a wide selection of bar equipment, designed to combine easy use with efficiency and style. The tools are flanked by fascinating accessories making every moment trendy and lively. To share refined happy hours, to enjoy spectacular cocktails and long drinks, or to add style to every sort of drink.

Paderno propone un'ampia selezione di attrezzature bar, ideata per unire praticità d'utilizzo a efficienza e stile. Agli utensili si affiancano affascinanti accessori in grado di rendere trendy e vivace ogni momento. Per condividere raffinati happy hour, per gustare scenografici cocktail e long drink, oppure per aggiungere stile a ogni tipo di bevanda.





SPECIAL THANKS TO : Ristorante I GEMELLI Via San Marco, 26, 20121 Milano, Italia



NEW
SS

Pumpkin mug

Coppa zucca
Kürbis-Becher
Gobelet citrouille
Vaso de calabaza

art.	Ø cm.	h. cm.	ml.	col.
44944G07	10	14,5	700	●
44944C07	10	14,5	700	●



NEW
SS

Pineapple cup with straw

Coppa ananas con cannuccia
Ananas-Becher mit Strohhalme
Gobelet ananas avec paille
Vaso de piña con pajita

art.	Ø cm.	h. cm.	ml.	col.
44945G05	9,5	20,5	500	●
44945C05	9,5	20,5	500	●



NEW
SS

Champagne glass

Flute champagne
Champagner Glas
Verre champagne
Copa champán

art.	Ø cm.	h. cm.	ml.	col.
41493G00	5	25,5	270	●
41493C00	5	25,5	270	●
41493B00	5	25,5	270	●



NEW
SS

Martini cup

Coppa martini
Martini Cocktail Glas
Verre à martini
Copa martini

art.	Ø cm.	h. cm.	ml.	col.
41494G00	12	16,5	200	●
41494C00	12	16,5	200	●
41494B00	12	16,5	200	●



NEW
SS

Margarita cup

Coppa margarita
Margarita Cocktail Glas
Verre à margarita
Copa margarita

art.	Ø cm.	h. cm.	ml.	col.
41498G00	10,5	14	220	●
41498C00	10,5	14	220	●
41498B00	10,5	14	220	●



SS

Moscow mule mug

Tazza moscow mule
Moscow Mule Becher
Gobelet moscow mule
Taza moscow mule

art.	Ø cm.	h. cm.	ml.	col.
41463-01	8,9	9	500	●



SS

Moscow mule mug
Tazza moscow mule
Moscow Mule Becher
Gobelet moscow mule
Taza moscow mule

art.	Ø cm.	h. cm.	ml.	col.
41463-02	8,5	9,7	500	●

Gold plated handle. – Manico dorato.



NEW

SS

Moscow mule mug, antique
Tazza moscow mule, antique
Moscow Mule Becher, Antik
Gobelet moscow mule, antique
Taza moscow mule, antiguo

art.	Ø cm.	h. cm.	ml.	col.
41463A05	8,5	9,7	500	●

Gold plated handle. – Manico dorato.



NEW

SS

Moscow mule mug
Tazza moscow mule
Moscow Mule Becher
Gobelet moscow mule
Taza moscow mule

art.	Ø cm.	h. cm.	ml.	col.
41463G05	8,5	9,7	500	●

Gold plated handle. – Manico dorato.



NEW

SS

Moscow mule mug
Tazza moscow mule
Moscow Mule Becher
Gobelet moscow mule
Taza moscow mule

art.	Ø cm.	h. cm.	ml.	col.
41463B05	8,5	9,7	500	●

Gold plated handle. – Manico dorato.



NEW

SS

Moscow mule mug
Tazza moscow mule
Becher Moscow Mule
Gobelet moscow mule
Taza moscow mule

art.	Ø cm.	h. cm.	lt.	col.
41463C30	15,5	17,5	3	●
41463C50	18,0	20,0	5	●

Gold plated handle. – Manico dorato.



NEW

SS

Moscow mule mug, antique
Tazza moscow mule, antique
Becher Moscow Mule, Antik
Gobelet moscow mule, antique
Taza moscow mule, antiguo

art.	Ø cm.	h. cm.	lt.	col.
41463A30	15,5	17,5	3	●
41463A50	18,0	20,0	5	●

Gold plated handle. – Manico dorato.

BAR HAPPY HOUR



NEW
SS

Mini moscow mule mug
Mini moscow mule
Moscow Mule Shotbecher
Moscow mule à shot
Chupito moscow mule

art.	Ø cm.	h. cm.	ml.	col.
41463C00	4,6	4,7	60	●

Gold plated handle. Set 4 pcs. – Manico dorato. Conf. 4 pz.



NEW
SS

Mini moscow mule mug, antique
Mini moscow mule, antique
Moscow Mule Shotbecher, Antik
Moscow mule à shot, antique
Chupito moscow mule, antiguo

art.	Ø cm.	h. cm.	ml.	col.
41463A00	4,6	4,7	60	●

Gold plated handle. Set 4 pcs. – Manico dorato. Conf. 4 pz.



NEW
SS

Mint julep cup
Coppa mint julep
Becher für Mint Julep
Tasse à cocktail mint julep
Vaso para mint julep

art.	Ø cm.	h. cm.	ml.	col.
41497-05	8,5	10,5	380	●
41497G05	8,5	10,5	380	●
41497C05	8,5	10,5	380	●
41497B05	8,5	10,5	380	●



NEW
SS

Julep mug
Tazza julep
Becher Julep
Gobelet julep
Taza julep

art.	Ø cm.	h. cm.	ml.	col.
41470C03	8	12	335	●



NEW
SS

Julep mug, antique
Tazza julep, antique
Becher Julep, Antik
Gobelet julep, antique
Taza julep, antiguo

art.	Ø cm.	h. cm.	ml.	col.
41470A03	8	12	335	●



NEW
SS

Mini mug
Mini tazza
Shotbecher
Verre à shot
Vaso de chupito

art.	Ø cm.	h. cm.	ml.	col.
41470C00	4,5	5,5	60	●

Set 4 pcs. – Conf. 4 pz.



NEW
SS

Mini mug, antique
Mini tazza, antique
Shotbecher, Antik
Verre à shot, antique
Vaso de chupito, antiguo

art.	Ø cm.	h. cm.	ml.	col.
41470A00	4,5	5,5	60	●

Set 4 pcs. – Conf. 4 pz.



NEW
SS

Straight straws

Cannucce
Strohhalme
Pailles
Pajitas

art.	Ø mm.	l. cm.	col.
41490-00	6	21,5	●
41490B00	6	21,5	●
41490G00	6	21,5	●
41490C00	6	21,5	●

Set 12 pcs plus 1 straw brush.
Conf. 12 pz + 1 scovolino.



NEW
SS

Curved straws

Cannucce curve
Gebogene Strohhalme
Pailles incurvées
Pajitas curvados

art.	Ø mm.	l. cm.	col.
41490-01	6	21,5	●
41490B01	6	21,5	●
41490G01	6	21,5	●
41490C01	6	21,5	●

Set 12 pcs plus 1 straw brush.
Conf. 12 pz + 1 scovolino.



NEW
SS

Straw brush, 5 pcs

Scovolini, 5 pezzi
Strohhalme-Bürste, 5 Stk.
Brosses à pailles, 5 pièces
Cepillos para pajitas, 5 pz

art.	l. cm.
41490-AA	21



NEW
B

Straight straws, 24 pcs

Cannucce, 24 pz
Strohhalme, 24 Stk
Pailles, 24 pièces
Pajitas, 24 piezas

art.	Ø mm.	l.
48310-14	5-7	140
48310-20	5-7	200



NEW
B

Straight straws, 150 pcs

Cannucce, 150 pz
Strohhalme, 150 Stk
Pailles, 150 pièces
Pajitas, 150 piezas

art.	Ø mm.	l.
48311-20	6-8	200
48311-25	6-8	250



NEW
B

Straight straws, 110 pcs

Cannucce, 110 pz
Strohhalme, 110 Stk
Pailles, 110 pièces
Pajitas, 110 piezas

art.	Ø mm.	l.
48312-25	9-10	250



Straight straws, 24 pcs

Cannucce, 24 pz
Strohhalme, 24 Stk
Pailles, 24 pièces
Pajitas, 24 piezas

art.	Ø mm.	l.
48313-14	10-12	140
48313-18	10-12	180
48313-20	10-12	200



3 Straight straws, 3 bent, glass

3 Cannucce diritte, 3 curve in vetro
3 Gerade Strohhalme, 3 gebogene aus Glas
3 Pailles droites, 3 incurvées en verre
3 Pajitas rectas, 3 curvados de vidrio

art.	Ø mm.	l.
41495-08	8	215
41495-10	10	215

Incl. 2 straw brushes. – Incl. 2 scovolini.



Drinks stirrers flamingo, 4 pcs

Miscelatori cocktail fenicottero, 4 pz
Flamingo-Cocktail Rührer, 4 Stk
Agitateurs cocktails flamant, 4 pcs
Agitadores cócteles flamingo, 4 pz

art.	l. cm.	col.
41491G00	21,5	●
41491C00	21,5	●



Drinks stirrers skull, 4 pcs

Miscelatori cocktail teschio, 4 pz
Totenkopf-Cocktail Rührer, 4 Stk
Agitateurs tête de mort, 4 pcs
Agitadores cócteles cráneo, 4 pz

art.	l. cm.	col.
41491G01	18,5	●
41491C01	18,5	●



Drinks stirrers pineapple, 4 pcs

Miscelatori cocktail ananas, 4 pz
Ananas-Cocktail Rührer, 4 Stk
Agitateurs cocktails ananas, 4 pcs
Agitadores cócteles piña, 4 pz

art.	l. cm.	col.
41491G02	20	●
41491C02	20	●



Drinks stirrers owl, 4 pcs

Miscelatori cocktail gufo, 4 pz
Eule-Cocktail Rührer, 4 Stk
Agitateurs cocktails hibou, 4 pcs
Agitadores cócteles búho, 4 pz

art.	l. cm.	col.
41491G03	20	●
41491C03	20	●



Drinks stirrers seahorse, 4 pcs

Miscelatori cavalluccio marino, 4 pz
Seepferdchen-Cocktail Rührer, 4 Stk
Agitateurs hippocampe, 4 pcs
Agitadores caballo de mar, 4 pz

art.	l. cm.	col.
41491G04	20,5	●
41491C04	20,5	●



Drinks stirrers bow-knot, 4 pcs

Miscelatori cocktail fiocco, 4 pz
Bogenknoten-Cocktail Rührer, 4 Stk
Agitateurs noeud d'arc, 4 pcs
Agitadores nudo de proa, 4 pz

art.	l. cm.	col.
41491G05	21	●
41491C05	21	●



NEW
SS

Drinks stirrers octopus, 4 pcs
Miscelatori cocktail polipo, 4 pz
Tintenfisch-Cocktail Rührer, 4 Stk
Agitateurs cocktails poulpe, 4 pcs
Agitadores cócteles pulpo, 4 pz

art.	l. cm.	col.
41491G06	18,5	●
41491C06	18,5	●



NEW
SS

Tweezer
Pinza
Zange
Pince
Pinza

art.	l. cm.	col.
42902-30	30	●
42902G30	30	●



NEW
SS

Tweezer
Pinza
Zange
Pince
Pinza

art.	l. cm.	col.
42902C30	30	●
42902B30	30	●



SS

Tweezer
Pinza
Zange
Pince
Pinza

art.	l. cm.
42902-31	30



SS

Cocktail spoon
Cucchiaio miscelatore
Cocktail-Löffel
Cuillère à cocktail
Cuchara cóctel

art.	l. cm.
41605-00	27



SS

Cocktail spoon
Cucchiaio miscelatore
Cocktail-Löffel
Cuillère à cocktail
Cuchara cóctel

art.	l. cm.	col.
41605-01	28	●



NEW
SS

Cocktail spoon
Cucchiaio miscelatore
Cocktail-Löffel
Cuillère à cocktail
Cuchara cóctel

art.	l. cm.	col.
41605G27	28	●
41605B27	28	●



NEW
SS

Cocktail spoon/fork
Cucchiaio/forchetta miscelatore
Cocktail-Löffel/-Gabel
Cuillère/fourchette à cocktail
Cuchara/tenedor cóctel

art.	l. cm.	col.
41605-03	50	●
41605G03	50	●



NEW
SS

Cocktail spoon/fork
Cucchiaio/forchetta miscelatore
Cocktail-Löffel/-Gabel
Cuillère/fourchette à cocktail
Cuchara/tenedor cóctel

art.	l. cm.	col.
41605C03	50	●
41605B03	50	●



SS

Ice tea spoon
Cucchiaio bibita
Limonadenlöffel
Cuillère à soda
Cuchara refresco

art.	l. cm.	U. Pack
41605-25	25	6



NEW
SS

Absinthe spoon
Cucchiaio assenzio
Absinth-Löffel
Cuillère d'absinthe
Cuchara de ajenjo

art.	l. cm.	col.
41600-00	16	●
41600G00	16	●
41600C00	16	●



SS

Magic spoon whisks
Cucchiaio magico
Zauberlöffel
Fouet plat à spirales
Cuchara mágica

art.	l. cm.
41595-20	20



NEW

SS

Strainer

Colino
Sieb
Passoire
Colador

art.	Ø cm.	col.
41570-10	10	●
41570G10	10	●



NEW

SS

Strainer

Colino
Sieb
Passoire
Colador

art.	Ø cm.	col.
41570C10	10	●
41570B10	10	●



NEW

SS

Cocktail strainer

Colino cocktail
Cocktail-Sieb
Passoire à cocktail
Colador cóctel

art.	Ø cm.	col.
41603-00	9	●
41603G00	9	●



NEW

SS

Cocktail strainer

Colino cocktail
Cocktail-Sieb
Passoire à cocktail
Colador cóctel

art.	Ø cm.	col.
41603C00	9	●
41603B00	9	●



NEW

SS

Julep strainer

Colino Julep
Julep Barsieb
Tamis cocktail Julep
Colador de cóctel

art.	Ø cm.	col.
41603-07	7,5	●
41603G07	7,5	●



NEW

SS

Julep strainer

Colino Julep
Julep Barsieb
Tamis cocktail Julep
Colador de cóctel

art.	Ø cm.	col.
41603C07	7,5	●
41603B07	7,5	●



NEW

SS

Cocktail measuring cup

Misurino cocktail
Alkohol-Meßbecher
Mesureur de cocktail
Medidor de cóctel

art.	ml.
41609-75	75



NEW

SS

Cocktail measuring cup

Misurino cocktail
Alkohol-Meßbecher
Mesureur de cocktail
Medidor de cóctel

art.	ml.	col.
41609-36	30/60	●
41609G36	30/60	●
41609C36	30/60	●
41609B36	30/60	●



SS

Cocktail measuring cup

Misurino cocktail
Alkohol-Meßbecher
Mesureur de cocktail
Medidor de cóctel

art.	ml.	col.
41604-00	20/40	●
41604G00	20/40	●
41604C00	20/40	●
41604B00	20/40	●



SS

Japanese jigger

Misurino cocktail
Cocktail-Doppelmaß
Measure double jigger
Medidor de cóctel

art.	ml.	col.
41604-01	20/40	●
41604G01	20/40	●
41604C01	20/40	●
41604B01	20/40	●



NEW

SS

Long-drink shaker

Shaker
Shaker
Shaker
Coctelera

art.	Ø cm.	h. cm.	ml.	col.
41484-05	8,8	20,5	500	●
41484G05	8,8	20,5	500	●
41484C05	8,8	20,5	500	●
41484B05	8,8	20,5	500	●



SS

Long-drink shaker

Shaker
Shaker
Shaker
Coctelera

art.	ml.
41480-03	200
41480-05	500
41480-07	700



SS

SAN

Long-drink shaker

Shaker
Shaker
Shaker
Coctelera

art.	ml.	col.
41481-02	550	●
41481-03	550	●



AY

Long-drink shaker

Shaker
Shaker
Shaker
Coctelera

art.	ml.
41483-04	420
41483-06	660



NEW
SS

Long-drink shaker

Shaker

Shaker

Shaker

Coctelera

art.	Ø cm.	h. cm.	ml.	col.
41480G05	8,7	20,5	500	●
41480C05	8,7	20,5	500	●
41480B05	8,7	20,5	500	●



NEW
SS

Shaker parisienne

Shaker parisienne

Shaker parisienne

Shaker parisienne

Coctelera parisienne

art.	Ø cm.	h. cm.	ml.	col.
41461-07	9	23	700	●
41461G07	9	23	700	●
41461C07	9	23	700	●
41461B07	9	23	700	●



NEW
SS

Shaker calabrese

Shaker calabrese

Shaker Calabrese

Shaker calabrese

Coctelera calabrese

art.	Ø cm.	h. cm.	ml.	col.
41464-09	9,5	24,5	900	●
41464G09	9,5	24,5	900	●
41464C09	9,5	24,5	900	●
41464B09	9,5	24,5	900	●



NEW
SS

Boston tin + half tin

Shaker boston 2 pz

Boston Shaker, 2 Stk

Shaker boston, 2 pcs

Coctelera boston, 2 pz

art.	Ø cm.	ml.	col.
41467G08	9	790/590	●
41467C08	9	790/590	●
41467B08	9	790/590	●



SS

Boston shaker, vinyl coated

Cono boston, rivestimento vinile

Boston-Shaker, Vinyl Überzug

Shaker boston, revêtement en vinyle

Coctelera boston, revestimiento vinilo

art.	Ø cm.	h. cm.	ml.	col.
41479-11	9	18	830	●
41479-12	9	18	830	●
41479-13	9	18	830	●
41479-14	9	18	830	●
41479-15	9	18	830	○



SS

Boston shaker

Cono boston con fondello

Boston-Shaker

Shaker boston

Coctelera boston

art.	Ø cm.	h. cm.	ml.
41479-05	9	17	500



Mixing glass

Bicchiere vetro
Becherglas
Verre
Vaso vidrio

art.	Ø cm.	h. cm.	ml.
41479-AA	8,5	15	500



Mixing glass

Bicchiere vetro
Becherglas
Verre
Vaso vidrio

art.	Ø cm.	h. cm.	ml.
41478-50	8,8	15	473
41478-35	8,3	13	355



Mixing glass

Bicchiere vetro
Becherglas
Verre
Vaso vidrio

art.	Ø cm.	h. cm.	ml.
41477-50	9	15	473

With ounce markings. – Graduato in once.



Mixing glass with lip

Bicchiere miscelatore con becco versatore
Rührglas mit Lippe
Verre mélangeur avec bec verseur
Vaso mezclador vertedor con pico

art.	Ø cm.	h. cm.	lt.
41514-05	9	16,5	0,5



Mixing glass with lip

Bicchiere miscelatore con becco versatore
Rührglas mit Lippe
Verre mélangeur avec bec verseur
Vaso mezclador vertedor con pico

art.	Ø cm.	h. cm.	lt.
41514-10	11,5	19	0,95



PC

Whiskey glass

Bicchiere whiskey
Whiskey Glas
Verre à whiskey
Vaso para whiskey

art.	Ø cm.	h. cm.	ml.
44940-01	8,5	9,5	420

U.Pack 6 pcs



PC

Juice glass

Bicchiere succo
Fruchtsaft-Glas
Verre à jus
Vaso para zumo

art.	Ø cm.	h. cm.	ml.
44940-02	7,5	15,5	460

U.Pack 6 pcs



PC

Beer glass

Boccale birra
Bier-Glas
Verre à bière
Vaso para cerveza

art.	Ø cm.	h. cm.	ml.
44940-06	8	23	450

U.Pack 6 pcs



MS

Beer glass

Boccale birra
Bier-Glas
Verre à bière
Vaso para cerveza

art.	Ø cm.	h. cm.	ml.
44940-08	9	16	500

U.Pack 6 pcs



PC

Margarita glass

Bicchiere margarita
Margarita-Glas
Verre à margarita
Vaso margarita

art.	Ø cm.	h. cm.	ml.
44940-10	12	18	300

U.Pack 6 pcs





PC

Martini glass
Bicchieri martini
Martini-Glas
Verre à martini
Vaso martini

art.	Ø cm.	h. cm.	ml.
44940-11	12	17	240

U.Pack 6 pcs



PC

Wine glass
Bicchiere vino
Wein-Glas
Verre à vin
Vaso vino

art.	Ø cm.	h. cm.	ml.
44940-12	7	21	300

U.Pack 6 pcs



PC

Wine glass
Bicchiere vino
Wein-Glas
Verre à vin
Vaso vino

art.	Ø cm.	h. cm.	ml.
44940-13	7	19	200

U.Pack 6 pcs



PC

Champagne glass
Bicchiere spumante
Sekt-Glas
Flûte
Vaso champaña

art.	Ø cm.	h. cm.	ml.
44940-14	5	22	180

U.Pack 6 pcs



PC

Mixing glass
Bicchiere
Glas
Verre
Vaso

art.	Ø cm.	h. cm.	ml.
44940-16	9	16	540

U.Pack 6 pcs



PC

Whiskey/rocks glass
Bicchiere whiskey/rocks
Whiskey-/Rocks-Glas
Verre à whiskey/rocks
Vaso para whiskey/rocks

art.	Ø cm.	h. cm.	ml.
44940-17	9	12	420

U.Pack 6 pcs



PC

Whiskey/rocks glass
Bicchiere whiskey/rocks
Whiskey-/Rocks-Glas
Verre à whiskey/rocks
Vaso para whiskey/rocks

art.	Ø cm.	h. cm.	ml.
44940-18	8,5	11,5	420

U.Pack 6 pcs



PC

Cooler
Bicchiere
Glas
Verre
Vaso

art.	Ø cm.	h. cm.	ml.
44940-19	8	17	540

U.Pack 6 pcs



PC

Tumbler
Bicchiere
Trinkbecher
Gobelet
Vaso

art.	Ø cm.	h. cm.	ml.
44940-24	7,5	12,5	360
44940-25	8,0	13,5	480
44940-26	8,5	16,0	660

U.Pack 6 pcs



PC

Tumbler

Bicchiere
Trinkbecher
Gobelet
Vaso

art.	Ø cm.	h. cm.	ml.
44940-32	7,5	12,5	360
44940-33	8,0	13,5	480
44940-34	8,5	16,0	660

U.Pack 6 pcs



SAN

Tumbler

Bicchiere
Trinkbecher
Gobelet
Vaso

art.	Ø cm.	h. cm.	ml.
44990-15	5,5	9,5	150
44990-24	6,5	10,0	240
44990-29	7,0	11,0	290
44990-36	7,5	13,0	360
44990-48	8,0	15,0	480

U.Pack 6 pcs



PP

Cover with spout

Coperchio con beccuccio
Deckel mit Ausguss
Couvercle avec bec
Tapa con boquilla

art.	Ø cm.	U. Pack
44871-23	7	50



PC

Water tumbler

Bicchiere acqua
Wasserglas
Verre à eau
Vaso agua

art.	Ø cm.	h. cm.	ml.
44871-20	7,0	7,0	170
44871-21	7,0	10,2	250
44871-22	7,8	11,4	350

**U.Pack 10 pcs – Colored on demand MOQ 50 pcs
Colorati su richiesta MOQ 50 pz.**



MS

Cocktail glass

Bicchiere cocktail
Cocktail Glas
Verre à cocktail
Vaso cocktail

art.	Ø cm.	h. cm.	ml.
44942-01	8	21	350

U.Pack 6 pcs



MS

Cocktail glass

Bicchiere cocktail
Cocktail Glas
Verre à cocktail
Vaso cocktail

art.	Ø cm.	h. cm.	ml.
44942-02	11	21	460

U.Pack 6 pcs



MS

Martini glass

Bicchiere martini
Martini-Glas
Verre à martini
Vaso martini

art.	Ø cm.	h. cm.	ml.
44942-03	10,5	20	340

U.Pack 6 pcs



MS

Cocktail glass

Bicchiere cocktail
Cocktail Glas
Verre à cocktail
Vaso cocktail

art.	Ø cm.	h. cm.	ml.
44942-04	7,5	23	220

U.Pack 6 pcs



MS

Margarita glass

Bicchieri margarita
Margarita-Glas
Verre à margarita
Vaso margarita

art.	Ø cm.	h. cm.	ml.
44942-05	12	17,5	340

U.Pack 6 pcs



SS

Fruit basket

Cestino agrumi
Obstkorb
Panier à fruits
Cesta frutas

art.	Ø cm.	h. cm.
41611-20	21,5	20



Orange juicer, chromed

Spremiagrumi manuale, cromato
Orangenpresse, verchromt
Presse-agrumes, chromé
Exprimidor de cítricos, cromado

art.	dim. cm.
41456-02	18x13x46



SS

Lemon squeezer

Spremilimone
Zitronenpresse
Presse citron
Exprime limones

art.	dim. cm.
41606-00	12,5x6,5



SS

Lemon squeezer

Spremilimone
Zitronenpresse
Presse citron
Exprime limones

art.	dim. cm.
41606-01	7x8,5



Lemon squeezer, aluminum

Spremilimone, alluminio
Zitronenpresse, aluminum
Presse citron, alu
Exprime limones, aluminio

art.	l. cm.
41606-02	20



Soda siphon

Sifone soda
Soda Siphon
Siphon à eau de seltz
Sifón agua de seltz

art.	lt.
41453-11	1



Soda siphon

Sifone soda
Soda Siphon
Siphon à eau de seltz
Sifón agua de seltz

art.	lt.
41465-10	1



Soda siphon

Sifone soda
Soda Siphon
Siphon à eau de seltz
Sifón agua de seltz

art.	lt.
41454-01	1



2 Bottles Twist&Sparkle

2 Bottiglie Twist&Sparkle
2 Flaschen Twist&Sparkle
2 Bouteilles Twist&Sparkle
2 Bottiglie Twist&Sparkle

art.	lt.
41454-99	1



Soda chargers, 10-pcs set

Ricariche soda, 10 pezzi
10-Stk. Sodakapseln-Packung
Capsules à eau de seltz, set 10 pcs
Cápsulas para agua de seltz, 10 pz

art.
41453-AA

Content: 8 g of CO₂. – Contenido: 8 gr di CO₂.



Ice pick

Rompighiaccio
Eisstößel
Casse-glace
Pico para hielo

art.	l. cm.
44105-00	23

Wooden handle. – Manico legno.



Muddler, plastic
Pestaghiaccio, plastica
Eiszerstosser, Kunststoff
Pic à glace, plastique
Pico para hielo, plástico

art.	l. cm.
41503-22	22,5



Muddler
Pestaghiaccio
Eiszerstosser
Pic à glace
Pico para hielo

art.	l. cm.
41503-21	20

NEW
SS



Ice crusher, chromed
Tritaghiaccio, cromato
Eiswolf, verchromt
Broyer à glace, chromé
Trituradora de hielo, cromada

art.	dim. cm.
41457-00	15x12x26



SS

Ice scoop
Sessola per ghiaccio
Eisschaufel
Pelle à glace
Librador para hielo

art.	ml.
41503-00	100



PC

Ice scoop
Sessola per ghiaccio
Eisschaufel
Pelle à glace
Librador para hielo

art.	ml.
14958-01	100
14958-02	250



SS

Ice spoon
Cucchiaio ghiaccio
Eislöffel
Cuillère à glace
Cuchara hielo

art.	l. cm.
52550-04	22



PP

Mold for ice-balls
Stampo per sfere di ghiaccio
Eis-Kugel-Former
Moule pour boules de glace
Molde de cubitos de hielo esféricos

art.	dim. cm.
41515-03	24x8,5

For 3 balls ø 5,5 cm, 100 ml.
Per 3 sfere ø 5,5 cm da 100 ml.



NEW

Mold for ice-skulls, silicone
Stampo teschi ghiaccio, silicone
Eis-Schädel-Former, Silikon
Moule pour crânes de glace, silicone
Molde de crâneos de hielo, silicona

art.	dim. cm.
41515-05	11x8



NEW

Mold for ice-diamonds, silicone
Stampo diamanti ghiaccio, silicone
Eis-Diamant-Former, Silikon
Moule pour diamants de glace, silicone
Molde de diamante de hielo, silicona

art.	dim. cm.
41515-07	12x12



NEW
SS

Ice tong
Molla ghiaccio
Eiszange
Pince à glace
Pinza hielo

art.	l. cm.	col.
41518G12	16	●
41518C12	16	●
41518B12	16	●



Ice bucket with tong
Secchio ghiaccio e pinza
Eiseimer mit Eiszange
Seau à glace avec pince
Cubo hielo con pinza

art.	Ø mm.	h. cm.	lt.
41513-13	14	22	1,3

Noble plastic jacket highly chrome plated with special insulated plastic insert. – Camicia in materiale plastico, finitura cromata lucida con speciale inserto termico.



Ice bucket, plastic

Secchio ghiaccio, plastica
Eiseimer, Kunststoff
Seau à glace, plastique
Cubo hielo, plástico

art.	Ø mm.	h. cm.	lt.
41512-15	15	15	1,5
41512-30	20	18	3,0

**Satin metal look with highly polished edge.
Special insulated plastic insert.**
Finitura effetto metallo satinato, bordo lucido.
Speciale inserto termico.



PP
SAN

Ice box

Secchio ghiaccio
Eisbox
Seau à glaçons
Cubitera

art.	dim. cm.	lt.
41512-50	27x27x15	5,4

With drainer. – Con griglia.



SS

Ice bucket

Secchio ghiaccio
Eisbehälter
Seau à glace
Cubitera hielo

art.	Ø cm.	h. cm.
56116-15	12,5	13



NEW
SS

Ice bucket

Secchiello ghiaccio
Eisbehälter
Seau à glace
Cubitera hielo

art.	Ø cm.	h. cm.	lt.	col.
41513G20	15	14	2	●
41513C20	15	14	2	●
41513B20	15	14	2	●



Bar organizer

Porta oggetti da bar
Bar-Behälter
Présentoir de bar
Dispensador bar

art.	dim. cm.
44102-24	24x14,5x11

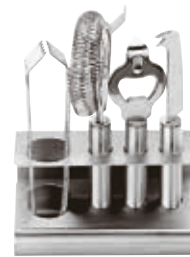

SS

Bar set, 5 pieces

Set da bar, 5 pezzi
Bar-Set, 5-tlg.
Set 5 pièces à cocktail
Juego 5 piezas cóctel

art.
41510-05



Flair bottle

Flair bottle
Flair bottle
Flair bottle
Flair bottle

art.	lt.	col.
44108-01	0,75	○
44108-02	0,75	●



NEW

Skull dash bottle

Bottiglia angostura teschio
Schädel Dash Bottle
Dash bottle crâne
Dash bottle cráneo

art.	ml.
41680-03	30
41680-06	60
41680-12	120





NEW

Atomizer dash bottle
Bottiglia angostura spray
Bitter Flasche Atomizer
Vaporisateur d'angostura
Botella angostrura spray

art.	ml.
41681-10	100



NEW

Dash bottle
Bottiglia angostura
Bitter Flasche
Dash bottle
Botella angostrura

art.	ml.
41681-06	150



Dash Bottle
Bottiglia angostura
Bitter Flasche
Dash Bottle
Botella Angostrura

art.	dim. cm.	ml.
41681-01	6,5x6,5x10	100



Dash Bottle
Bottiglia angostura
Bitter Flasche
Dash Bottle
Botella Angostrura

art.	Ø cm.	h. cm.	ml.
41681-03	8,5	15	280



Dash Bottle
Bottiglia angostura
Bitter Flasche
Dash Bottle
Botella Angostrura

art.	dim. cm.	ml.
41681-02	6x5x15	200

Without pourer. – Senza dosatore.



Dash Bottle
Bottiglia angostura
Bitter Flasche
Dash Bottle
Botella Angostrura

art.	Ø cm.	h. cm.	ml.
41681-04	6,2	10	100

Without pourer. – Senza dosatore.



Dash bottle pourer
Tappo versatore
Ausgiesser
Bouchon verseur
Tapón vertedor

art.
41681-99



PP

Store & pour container
Contentore versatore
Dosier-Vorratsbehälter, komplett
Bouteille verseuse
Recipiente vertedor

art.	Ø cm.	h. cm.	lt.	col.
44106W05	9,0	26	0,5	○
44106W10	9,0	33	1,0	○
44106W20	12,5	35	2,0	○
44106W25	12,5	39	2,5	○



PP

Store & pour container

Contentitore versatore
Dosier-Vorratsbehälter, komplett
Bouteille verseuse
Recipiente vertedor

art.	Ø cm.	h. cm.	lt.	col.
44106G05	9,0	26	0,5	●
44106G10	9,0	33	1,0	●
44106G20	12,5	35	2,0	●
44106G25	12,5	39	2,5	●



PP

Store & pour container

Contentitore versatore
Dosier-Vorratsbehälter, komplett
Bouteille verseuse
Recipiente vertedor

art.	Ø cm.	h. cm.	lt.	col.
44106Y05	9,0	26	0,5	●
44106Y10	9,0	33	1,0	●
44106Y20	12,5	35	2,0	●
44106Y25	12,5	39	2,5	●



PP

Store & pour container

Contentitore versatore
Dosier-Vorratsbehälter, komplett
Bouteille verseuse
Recipiente vertedor

art.	Ø cm.	h. cm.	lt.	col.
44106R05	9,0	26	0,5	●
44106R10	9,0	33	1,0	●
44106R20	12,5	35	2,0	●
44106R25	12,5	39	2,5	●



PP

Store & pour container

Contentitore versatore
Dosier-Vorratsbehälter, komplett
Bouteille verseuse
Recipiente vertedor

art.	Ø cm.	h. cm.	lt.	col.
44106O05	9,0	26	0,5	●
44106O10	9,0	33	1,0	●
44106O20	12,5	35	2,0	●
44106O25	12,5	39	2,5	●



PP

Store & pour container

Contentitore versatore
Dosier-Vorratsbehälter, komplett
Bouteille verseuse
Recipiente vertedor

art.	Ø cm.	h. cm.	lt.	col.
44106B05	9,0	26	0,5	●
44106B10	9,0	33	1,0	●
44106B20	12,5	35	2,0	●
44106B25	12,5	39	2,5	●



PP

Storage canister

Contentitore di riserva
Vorratsbehälter
Réipient réserve
Recipiente reserva

art.	Ø cm.	h. cm.	lt.	col.
44107W05	9,0	9,5	0,5	○
44107W10	9,0	16	1,0	○
44107W20	12,5	20	2,0	○
44107W25	12,5	23	2,5	○



PP

Storage canister

Contentitore di riserva
Vorratsbehälter
Réipient réserve
Recipiente reserva

art.	Ø cm.	h. cm.	lt.	col.
44107G05	9,0	9,5	0,5	●
44107G10	9,0	16	1,0	●
44107G20	12,5	20	2,0	●
44107G25	12,5	23	2,5	●



PP

Storage canister

Contentitore di riserva
Vorratsbehälter
Réipient réserve
Recipiente reserva

art.	Ø cm.	h. cm.	lt.	col.
44107Y05	9,0	9,5	0,5	●
44107Y10	9,0	16	1,0	●
44107Y20	12,5	20	2,0	●
44107Y25	12,5	23	2,5	●



PP

Storage canister

Contentitore di riserva
Vorratsbehälter
Réipient réserve
Recipiente reserva

art.	Ø cm.	h. cm.	lt.	col.
44107R05	9,0	9,5	0,5	●
44107R10	9,0	16	1,0	●
44107R20	12,5	20	2,0	●
44107R25	12,5	23	2,5	●



PP

Storage canister

Contentore di riserva
Vorratsbehälter
Réceptient réserve
Recipiente reserva

art.	Ø cm.	h. cm.	lt.	col.
44107O05	9,0	9,5	0,5	●
44107O10	9,0	16	1,0	●
44107O20	12,5	20	2,0	●
44107O25	12,5	23	2,5	●



PP

Storage canister

Contentore di riserva
Vorratsbehälter
Réceptient réserve
Recipiente reserva

art.	Ø cm.	h. cm.	lt.	col.
44107B05	9,0	9,5	0,5	●
44107B10	9,0	16	1,0	●
44107B20	12,5	20	2,0	●
44107B25	12,5	23	2,5	●



Pouring container cap

Tappo per versatore
Dosier-Behälterstopfen
Bouchon à bouteille verseuse
Tapón para recipiente vertedor

art.	pcs/pz
44106-12	12



ABS

Condiment holder

Portacondimenti
Bar-Beilagenbehälter
Boîte à condiments
Caja condimentos

art.	dim. cm.	comp.
44103-03	49x15x9	3
44103-04	49x15x9	4
44103-06	49x15x9	6



SS

Condiment holder

Portacondimenti
Bar-Beilagenbehälter
Boîte à condiments
Caja condimentos

art.	dim. cm.	comp.
41782-04	32x16x10	4
41782-05	39x16x10	5
41782-06	47x16x10	6



Glass rimmer

Bordatore bicchieri
Bar-Kombination Salz-/Zuckerumrander
Système de givrage de verres
Ribeteador de vasos

art.	Ø cm.
44101-03	15,5



PE

Bar liner

Tappeto sottobicchieri
Gläsermatte
Revêtement de bar
Tapete para vasos

art.	dim. cm.
44099-03	60x1300

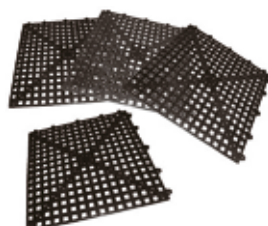

Bar mat, non-slip

Tappeto antiscivolo componibile
Gläserabstellmatte, rutschfest
Tapis antidérapant, componible
Alfombra antiderrapante, componible

art.	dim. cm.
44100-04	30x30



Bar runner

Tappetino bar
Gläserabstellmatte
Tapis à verres
Tapete para vasos

art.	dim. cm.
44100-01	68x8
44100-02	45x30



Barman's set, 20 pcs

Valigia Barman, 20 pz
Barman-Koffer, 20 Stk.
Mallette de barman, 20 pièces
Alfombra, 20 piezas

art.	des.
14480-20	Comprende/includes:
41479-05	boston shaker
41480-05	shaker
41503-22	pestello/ice beater
41595-20	cucchiaio magico/magic spoon
41603-00	colino/strainer
41604-00	misurino/measuring cup
41605-00	miscelatore/mixing spoon
41606-00	spremilimone/lemon squeezer
41606-01	spremilimone/lemon squeezer
41606-02	spremilime/lime squeezer

art.	des.
41608-04	tappo/champagne stopper
41699-06	cavatappi/corkscrew
44058-10	tappo dosatore/dispenser plug 10ml
48280-02	levacapsule/bottle opener
48280-56	coltello barman/barman knife
48280-92	rigalimoni/lemon stripper
48280-96	pelarance/orange peeler
52550-04	cucchiaio ghiaccio/ice spoon
52550-36	cucchiaio bibita/cocktail spoon
52550-55	molla ghiaccio/ice tong



SS

Speed rack
Rastrelliera
Flaschenregal
Rack à bouteilles
Estantería bar para botellas

art.	dim. cm.	bot.
44060-50	56x10,5x15,5	6
44060-80	81x10,5x15,5	8
44060-99	107x10,5x15,5	10



SS

Speed rack
Rastrelliera
Flaschenregal
Rack à bouteilles
Estantería bar para botellas

art.	dim. cm.	bot.
44060-51	56x21x15,5	2x 6



SS

Glass shelf rack
Rastrelliera, fissaggio sospeso
Gläserhalter Regalmontage
Rack à verres fixation suspendue
Rack de copas, fijación techo

art.	dim. cm.
44060-01	45x31,6x5,5



SS

Glass wall rack

Rastrelliera, fissaggio murale
Gläserhalter Wandmontage
Rack à verres fixation murale
Rack de copas, fijación mural

art. dim. cm.
44060-02 45x31,6x5,6



SS

Glass cleaning brush

Lavabicchieri
Gläserpüler
Brosse lave-verres
Cepillo lavavasos

art. dim. cm.
44135-02 38x18x29



Glass cleaning brush, nylon

Spazzole lavabicchieri, nylon
Bierglasbürstenständer, nylon
Brosse lave-verres, nylon
Cepillo lavavasos, nilón

art. h. cm.
44130-02 16,5
44130-03 21,5



Glass cleaning brush, nylon-aluminum

Spazzola lavabicchieri, nylon-alluminio
Bierglasbürstenständer, Nylon-Aluminium
Brosse lave-verres, nylon-alu
Cepillo lavavasos, nilón-aluminio

art. Ø cm. h. cm.
44130-01 15 19



Aluminum wall mounter bottle rack

Supporto a parete, alluminio
Alu-Wandständer
Support pour bouteilles en aluminium
Soporte mural, aluminio

art. l. cm. bot.
44056-04 41 4
44056-06 67 6

Dispensers not included. – Dosatori non inclusi.



Revolving bottle rack

Supporto rotante da banco
Theken-Drehständer vollständig
Support rotatif de comptoir
Soporte giratorio

art. h. cm. bot.
44057-04 70 4
44057-06 70 6

Dispensers not included. – Dosatori non inclusi.



Standard aluminum support

Supporto bottiglia, alluminio
Alu-Standard Ständer,
Support en aluminium
Soporte de botella, aluminio

art. col.
44056-01 ●
44056-11 ●
44056-21 ●

Universal fitting, shelf or wall mounting.

Fissaggio universale, a ripiano o parete.



Chrome plated dispenser

Dosatore cromato
Verchromter Dosierer
Doseur chromé
Dosificador cromado

art. ml.
44055-10 10
44055-50 50



Chrome plated dispenser

Dosatore cromato
Verchromter Dosierer
Doseur chromé
Dosificador cromado

art. ml.
44055-20 20
44055-25 25
44055-30 30
44055-35 35
44055-40 40



Dispenser

Dosatore
Dosierer
Doseur
Dosificador

art.	ml.	col.
44055G30	30	●
44055G40	40	●
44055C30	30	●
44055C40	40	●



Automatic dispenser plug

Tappo dosatore automatico
Automatischer Portionierer
Bouchon doseur automatique
Bola dosificadora

art.	ml.
44058-20	20
44058-25	25
44058-30	30



Automatic dispenser plug

Tappo dosatore automatico
Automatischer Portionierer
Bouchon doseur automatique
Bola dosificadora

art.	ml.
44058-10	10
44058-40	40
44058-50	50



SS

Bottle pourer with stopper

Tappo versatore con chiusura
Ausgießer mit Kappe
Bouchon avec clapet
Tapón vertedor con clerre

art.	pcs/pz
44111-02	2



Free flow pourer

Tappo versatore continuo
Permanentaussgiesser
Bouchon verseur continu
Vertedor continuo

art.	pcs/pz	col.
44110-01	12	●
44110-02	12	●
44110-03	12	●



Free flow pourer

Tappo versatore continuo
Permanentaussgiesser
Bouchon verseur continu
Vertedor continuo

art.	pcs/pz	col.
44110-04	12	●
44110-05	12	○
44110-06	12	●



Free flow pourer

Tappo versatore continuo
Permanentaussgiesser
Bouchon verseur continu
Vertedor continuo

art.	pcs/pz
44110-00	12



Measuring pourer

Tappo versatore dosatore
Dosierausgiesser
Bouchon verseur doseur
Tapón vertedor dosificador

art.	U. Pack	col.
44119-01	6	●
44119-02	6	●
44119-03	6	●
44119-04	6	●
44119-06	6	●



Measuring pourer

Tappo versatore dosatore
Dosierausgiesser
Bouchon verseur doseur
Tapón vertedor dosificador

art.
44114-01
44114-02
44114-03

SS



Measured pourer

Tappo metrico
Portioniererausgiesser
Bouchon doseur
Caños dosificador

art.	ml.	U. Pack	col.
44118-10	10	6	●
44118-20	20	6	●
44118-25	25	6	●
44118-30	30	6	●



Measured pourer

Tappo metrico
Portioniererausgiesser
Bouchon doseur
Caños dosificador

art.	ml.	U. Pack	col.
44118-35	35	6	●
44118-40	40	6	●
44118-50	50	6	○



Whiskey pourer

Tappo versatore
Ausgiesser
Bouchon verseur
Vertedor

art.	pcs/pz	col.
44112-01	12	●
44112-02	12	○



Champagne stopper

Tappo spumante
Sektflaschenstopfen
Bouchon à champagne
Tapón Champaña

art.
41608-20



Champagne stopper

Tappo spumante
Sektflaschenstopfen
Bouchon à champagne
Tapón Champaña

art.
41608-04

SS



Champagne stopper

Tappo spumante
Sektflaschenstopfen
Bouchon à champagne
Tapón Champaña

art.
41608-08

SS



SS

Champagne stopper

Tappo spumante
Sektflaschenstopfen
Bouchon à champagne
Tapón Champaña

art.
41608-00



SS

Champagne stopper

Tappo spumante
Sektflaschenstopfen
Bouchon à champagne
Tapón Champaña

art.
56796-00



SS

Wine stopper

Tappo vino
Weinflaschenstopfen
Bouchon à vin
Tapón vino

art.
41608-03



Foil cutter

Taglia capsula
Folienschneider
Coupe-capsules
Cortacápsulas

art.
49858-07



Winged corkscrew

Cavatappi a doppia leva
Korkenzieher mit Doppelhebel
Tire-bouchon à double levier
Sacacorchos a doble palanca

art.
41699-10



Winged corkscrew

Cavatappi a doppia leva
Korkenzieher mit Doppelhebel
Tire-bouchon à double levier
Sacacorchos a doble palanca

art.
41699-11



Waiter's corkscrew

Cavatappi cameriere
Kellner Korkenzieher
Tire-bouchon sommelier
Sacacorchos camarero

art.
41699-20



Waiter's corkscrew

Cavatappi cameriere
Kellner Korkenzieher
Tire-bouchon sommelier
Sacacorchos camarero

art.
41699-06



Lever corkscrew

Cavatappi a leva
Korkenzieher
Tire-bouchon
Sacachorcos

art.
49858-01



Lever corkscrew

Cavatappi a leva
Korkenzieher
Tire-bouchon
Sacachorcos

art.
49858-00



Waiter's corkscrew case

Valigetta cameriere
Kellner Korkenzieher-Koffer
Mallette tire-bouchon sommelier
Maletín sacacorchos sumiller

art.
49858-06



Wall mounted uncorking machine

Cavatappi da parete
Wand-Korkenzieher
Tire-bouchon à paroi
Sacacorchos mural

art.
49859-00



Bottle opener with collector box

Levacapsule con contenitore di raccolta
Flaschenöffner mit Sammelbehälter
Décapsuleur avec récipient de récupération
Abridor de botellas + caja de recuperación

art. dim. cm.
48223-00 10,5x7,2x30



Bottle opener

Levacapsule
Flaschenöffner
Décapsuleur
Abrebotellas

art.	dim. cm.	col.
41699-18	18x4	●
41699G18	18x4	●
41699C18	18x4	●
41699B18	18x4	●



Bottle opener

Levacapsule
Flaschenöffner
Décapsuleur
Abrebotellas

art. dim. cm.
41699-12 11x4



Bottle opener

Levacapsule
Flaschenöffner
Décapsuleur
Abrebotellas

art. dim. cm.
41699-04 11x4



Bar blade holster with belt clip

Fondina per levacapsule
Flaschenöffner-Halter
Etui pour décapsuleur
Funda para abrebotellas

art. dim. cm.
41699-13 11x4



Bottle opener, nickelplated

Levacapsule nichelato
Flaschenöffner, vernickelt
Décapsuleur, nickelé
Abrebotellas, níquelado

art.
41699-03



SS
Etlund

Can punch and bottle opener

Apriscatole/levacapsule
Dosen-/Flaschenöffner
Ouvre-boîte/décapsuleur
Abrelatas/botellas

art.
49860-00



Vacuum pump wine preserver

Pompa sottovuoto per vino
Wein-Vakuum-Pumpe
Pompe à vide d'air
Bomba vacío vino

art.
41499-00



PC

Glass clip holder

Clip reggibicchieri
Glashalter
Clip porte-verre
Soporte para vidrio

art. U. Pack
44048-99 100



W

Toothpicks

Stuzzicadenti
Zahnstocher
Cure-dents
Palillos

art. l. cm. pcs/pz
48306-01 9 1000

Birch, double pointed, individually wrapped.
Betulla, 2 punte, imbustati singolarmente.



B

Noshikushi skewers

Spiedini noshikushi
Noshikushi Spieße
Brochettes noshikushi
Pinchos noshikushi

art. l. cm. pcs/pz
48300-42 10,5 100



B

Tepokushi skewers

Spiedini tepokushi
Tepokushi Spieße
Brochettes tepokushi
Pinchos tepokushi

art. l. cm. pcs/pz
48300-43 9 100
48300-33 15 100



NEW
SS

Cocktail picks, 4 pcs

Spiedini cocktail, 4 pz
Cocktailspießes, 4 Stk
Brochettes, 4 pièces
Palos, 4 piezas

art. l. cm. col.
41492-00 10 ●
41492G00 10 ●
41492C00 10 ●
41492B00 10 ●



PS

Spits, disposable

Spiedini, monouso
Fleischspieße, einweg
Brochettes, usage unique
Palos, desechables

art. l. cm. pcs/pz
48364-09 9 500
48364-12 12 500



PS

Forks, disposable

Forchettine, monouso
Gabeln, einweg
Fourchettes, usage unique
Tenedores, desechables

art. l. cm. pcs/pz
48362-01 8,5 500



PS

Spoons, disposable

Cucchiaiini, monouso
Löffel, einweg
Cuillers, usage unique
Cucharitas, desechables

art. l. cm. pcs/pz
48363-01 8,5 500



PS

Tasting glasses, disposable

Bicchierino degustazione, monouso
Verkostung Gläser, einweg
Verres dégustation, usage unique
Vasos degustación, desechables

art. Ø cm. h. cm. ml.
48353-01 8,5 6,5 120

Set 100 pcs. – Conf. 100 pz.



PS

Tasting glasses, disposable

Bicchierino degustazione, monouso
Verkostung Gläser, einweg
Verres dégustation, usage unique
Vasos degustación, desechables

art. Ø cm. h. cm. ml.
48354-01 4 8,5 70

Set 100 pcs. – Conf. 100 pz.



PS

Tasting dishes, disposable

Piattini degustazione, monouso
Verkostung Schalen, einweg
Assiettes dégustation, usage unique
Platillos degustación, desechables

art.	Ø cm.	h. cm.	ml.
48355-01	9	1,5	20

Set 100 pcs. – Conf. 100 pz.



PS

Tasting bowls, disposable

Ciotoline degustazione, monouso
Verkostung Schalen, einweg
Bols dégustation, usage unique
Bols degustación, desechables

art.	Ø cm.	ml.
48356-01	8,5	30

Set 100 pcs. – Conf. 100 pz.



PS

Tasting bowls, disposable

Ciotoline degustazione, monouso
Verkostung Schalen, einweg
Bols dégustation, usage unique
Bols degustación, desechables

art.	Ø cm.	ml.
48357-01	7,5	50

Set 100 pcs. – Conf. 100 pz.



PS

Tasting bowls, disposable

Ciotoline degustazione, monouso
Verkostung Schalen, einweg
Bols dégustation, usage unique
Bols degustación, desechables

art.	dim. cm.	ml.
48358-01	10,5x5x3	11

Set 100 pcs. – Conf. 100 pz.



PS

Tasting dishes, disposable

Piattini degustazione, monouso
Verkostung Schalen, einweg
Assiettes dégustation, usage unique
Platillos degustación, desechables

art.	Ø cm.	ml.
48359-01	6,5	15

Set 100 pcs. – Conf. 100 pz.



PS

Tasting dishes, disposable

Piattini degustazione, monouso
Verkostung Schalen, einweg
Assiettes dégustation, usage unique
Platillos degustación, desechables

art.	dim. cm.	ml.
48360-01	11x6,5x2	20

Set 100 pcs. – Conf. 100 pz.



PS

Tasting dishes, disposable

Piattini degustazione, monouso
Verkostung Schalen, einweg
Assiettes dégustation, usage unique
Platillos degustación, desechables

art.	dim. cm.	ml.
48361-01	11,5x10,5x1,5	30

Set 100 pcs. – Conf. 100 pz.



SS

Snack holder

Porta snack
Snack-Behälter
Conteneur à snack
Contenedor para snack

art.	Ø cm.	h. cm.	lt.
41524-09	9	8,5	0,33



SS

Snack holder, 4 pcs

Porta snack, 4 pz
Snack-Behälter, 4 Stk
Conteneur à snack, 4 pcs
Contenedor para snack, 4 pz

art.	Ø cm.	h. cm.	lt.
41524-04	7	6,5	0,15



SS

Snack holder

Porta snack
Snack-Behälter
Conteneur à snack
Contenedor para snack

art.	dim. cm.
41527-12	10x8,5x6,5
41527-13	13x10,5x9



SS

Snack holder

Porta snack
Snack-Behälter
Conteneur à snack
Contenedor para snack

art.	dim. cm.
41527-10	21,5x10,5x4,5
41527-11	26x13x5



SS

Snack holder

Porta snack
Snack-Behälter
Conteneur à snack
Contenedor para snack

art.	Ø cm.	h. cm.
41523-08	8	7,5
41523-09	9	8,5



SS

Snack holder
Mini colapasta
Mini-Seiher
Conteneur à snack
Contenedor para snack

art.	Ø cm.	h. cm.
41521-10	10	6



SS

Snack holder
Mini tegame
Mini-Servierfanne
Conteneur à snack
Contenedor para snack

art.	dim. cm.	lt.
41522-14	14,5x9,5x4,5	0,5



SS

PVD

Snack holder
Porta snack
Snack-Behälter
Conteneur à snack
Contenedor para snack

art.	dim. cm.	col.
41527G10	21,5x10,5x4,5	●
41527G11	26x13x5	●



SS

PVD

Snack holder
Porta snack
Snack-Behälter
Conteneur à snack
Contenedor para snack

art.	dim. cm.	col.
41527G12	10x8,5x6,5	●
41527G13	13x10,5x9	●



SS

PVD

Snack holder
Porta snack
Snack-Behälter
Conteneur à snack
Contenedor para snack

art.	Ø cm.	h. cm.	col.
41523G08	8	7,5	●
41523G09	9	8,5	●



SS

Snack holder
Porta snack
Snack-Behälter
Conteneur à snack
Contenedor para snack

art.	Ø cm.	h. cm.	lt.
41524-10	9,5	11,5	0,45



SS

Snack holder
Porta snack
Snack-Behälter
Conteneur à snack
Contenedor para snack

art.	Ø cm.	h. cm.	lt.
41524-11	8,5	8,5	0,35



SS

Snack holder
Porta snack
Snack-Behälter
Conteneur à snack
Contenedor para snack

art.	Ø cm.	h. cm.	lt.
41524-12	8,5	8,5	0,35



SS

PVD

Snack holder
Porta snack
Snack-Behälter
Conteneur à snack
Contenedor para snack

art.	Ø cm.	h. cm.	lt.	col.
41524C10	9,5	11,5	0,45	●



SS

PVD

Snack holder
Porta snack
Snack-Behälter
Conteneur à snack
Contenedor para snack

art.	Ø cm.	h. cm.	lt.	col.
41524C11	8,5	8,5	0,35	●



SS

PVD

Snack holder
Porta snack
Snack-Behälter
Conteneur à snack
Contenedor para snack

art.	Ø cm.	h. cm.	lt.	col.
41524C12	8,5	8,5	0,35	●

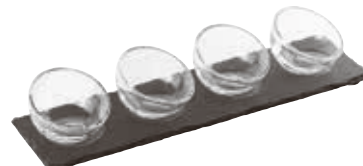

NEW

AR

5 pcs tasting/dessert set
Set 5 pz aperitivo/degustazione
5 Stück Verkostung/Dessert Set
Set 5 pcs dégustation/dessert
Juego de degustación/postre 5 pz

art.	dim. cm.	ml.
41205-01	35x10	4x43



NEW
AR

5 pcs tasting/dessert set
Set 5 pz aperitivo/degustazione
5 Stück Verkostung/Dessert Set
Set 5 pcs dégustation/dessert
Juego de degustación/postre 5 pz

art.	dim. cm.	ml.
41205-02	35x10	4x110



NEW
W

5 pcs tasting/dessert set
Set 5 pz aperitivo/degustazione
5 Stück Verkostung/Dessert Set
Set 5 pcs dégustation/dessert
Juego de degustación/postre 5 pz

art.	dim. cm.	ml.
41205-03	49x9,7x1,8	4x176



NEW
W

4 pcs tasting/dessert set
Set 4 pz aperitivo/degustazione
4 Stück Verkostung/Dessert Set
Set 4 pcs dégustation/dessert
Juego de degustación/postre 4 pz

art.	dim. cm.	ml.
41205-04	35x11x1,8	3x147



NEW
W

4 pcs tasting/dessert set
Set 4 pz aperitivo/degustazione
4 Stück Verkostung/Dessert Set
Set 4 pcs dégustation/dessert
Juego de degustación/postre 4 pz

art.	dim. cm.	ml.
41205-05	45x11x1,8	3x147



NEW
W

5 pcs tasting/dessert set
Set 5 pz aperitivo/degustazione
5 Stück Verkostung/Dessert Set
Set 5 pcs dégustation/dessert
Juego de degustación/postre 5 pz

art.	dim. cm.
41205-06	45x9x1,8



NEW
W

5 pcs tasting/dessert set
Set 5 pz aperitivo/degustazione
5 Stück Verkostung/Dessert Set
Set 5 pcs dégustation/dessert
Juego de degustación/postre 5 pz

art.	dim. cm.	ml.
41205-07	42x9x1,8	4x68



NEW
W

4 pcs canning Jar set
Set 4 pz Barattoli degustazione
4 Stück Verkostung-Gläser Set
Set 4 pcs dégustation/dessert
Juego de degustación/postre 4 pz

art.	dim. cm.	ml.
41205-08	27,5x11x4	3x200



NEW
W

7 pcs canning Jar set
Set 7 pz Barattoli degustazione
5 Stück Verkostung-Gläser Set
Set 7 pcs dégustation/dessert
Juego de degustación/postre 5 pz

art.	dim. cm.	ml.
41205-09	43x10x3	6x100



NEW
W

4 pcs tasting/dessert set
Set 4 pz aperitivo/degustazione
4 Stück Verkostung/Dessert Set
Set 4 pcs dégustation/dessert
Juego de degustación/postre 4 pz

art.	dim. cm.
41205-10	35x11x2



SERIES LIVING

TABLE TOP
TAVOLA



A complete stainless steel line, that is able to join assortment, beauty, strength and functionality. Quality items that can be used in order to set the most charming tables and buffets, but also in order to have a well-equipped kitchen. The easiest way to serve with charm any kind of dishes: from spaghetti to meat, fish, bread, vegetables, cheese and fruit. It is also indicated for tiny preparations such as sweets, olives and pickles. Nothing will unintentionally escape!

Una linea completa capace di coniugare assortimento, bellezza, robustezza e funzionalità, realizzata in acciaio inox. Oggetti di qualità per apparecchiare le tavole ed i buffet più raffinati, ma anche per disporre quotidianamente di una cucina super-attrezzata. Il modo più pratico per servire con eleganza e facilità ogni tipo di pietanza dagli spaghetti alla carne, pesce, pane, verdure, formaggi e frutta ma anche piccoli alimenti come dolci, olive e sottaceti. Niente potrà sfuggire inavvertitamente!



Vegetables serving plier

Forbice per verdure
Salad-/Gemüsezange
Pince à légumes
Pinza verduras

art.	dim. cm.
52550-81	24



Serving plier

Forbice tutto servire
Servierzange
Pince à servir
Pinza servir

art.	dim. cm.
52550-83	21,0
52550-84	26,5
52550-85	24,0



Pie plier

Forbice per torta
Kuchenzange
Pince à tarte
Pinza pasteles

art.	dim. cm.
52550-80	28



Hors-d'oeuvres and pastry plier

Forbice per antipasti e dolci
Vorspeisen-/Pâtisseriezange
Pince à hors-d'oeuvres et pâtisserie
Pinza entremeses y pasteles

art.	dim. cm.
52550-87	15
52550-89	20



Pastry plier

Forbice per dolci
Gebäckzange
Pince à pâtisserie
Pinza pasteles

art.	dim. cm.
52550-88	18



Grape scissor

Forbice uva
Traubenscher
Ciseaux à rasin
Tijeras uva

art.	dim. cm.
52550-91	14,5



Fruit tong

Molla per frutta
Fruchtzange
Pince à fruits
Pinza frutas

art.	dim. cm.
52550-50	23,5



Spaghetti-tong

Molla per spaghetti
Spaghettizange
Pince à spaghetti
Pinza espagueti

art.	dim. cm.
52550-73	21
52550-74	30



Toast and pastry tong

Molla per toast e dolci
Toast-/Gebäckzange
Pince à toast et tarte
Pinza pasteles y tostadas

art.	dim. cm.
52550-77	21
52550-78	24
52550-79	30



Multipurpose tong

Molla universale
Universalzange
Pince universelle
Pinza universal

art.	dim. cm.
52550-58	30



Serving tong

Molla tutto servire
Servierzange
Pince à servir
Pinza asados y verduras

art.	dim. cm.
52550-68	21
52550-69	26
52550-70	30



Bread and pastry tong

Molla per pane e pasticceria
Brot-/Gebäckzange
Pince à pain et pâtisserie
Pinza pan y pasteles

art.	dim. cm.
52550-62	18
52550-63	23
52550-64	26



Snail tong

Molla per lumache
Schneckenzange
Pince à escargots
Pinza caracoles

art.	dim. cm.
52550-60	17



Asparagus tong

Molla per asparagi
Spargelzange
Pince à asperges
Pinza espárragos

art.	dim. cm.
52550-66	23



Ice tong

Molla per ghiaccio
Eiszange
Pince à glace
Pinza hielo

art.	dim. cm.
52550-56	17,5



Sugar tong

Molla per zucchero
Zuckerzange
Pince à sucre
Pinza azúcar

art.	dim. cm.
52550-53	12



Sugar tong

Molla per zucchero
Zuckerzange
Pince à sucre
Pinza azúcar

art.	dim. cm.
52550-54	12,5



Ice tong

Molla per ghiaccio
Eiszange
Pince à glace
Pinza hielo

art.	dim. cm.
52550-55	18,5



Cake server

Pala torta
Tortenheber
Pelle à gâteau
Pala tarta

art.	dim. cm.
52550-02	30



Panettone knife

Coltello panettone
Tortenmesser
Couteau à gâteau
Cuchillo tarta

art.	dim. cm.
52550-34	32



Serving fork

Forchetta a servire
Serviergabel
Fourchette à servir
Tenedor servir

art.	dim. cm.
52550-11	29,5
52550-12	26,0
52550-23	39,0



Serving spoon

Cucchiaio a servire
Servierlöffel
Cuiller à servir
Cuchara servir

art.	dim. cm.
52550-13	30,0
52550-14	25,5
52550-22	39,0



Serving spoon perforated

Cucchiaio a servire forato
Servierlöffel, perforiert
Cuiller à servir perforée
Cuchara servir, perforada

art.	dim. cm.
52550-24	39,0
52550-25	25,5
52550-26	30,0



Ladle

Mestolo
Schöpfer
Louche
Cazo

art.	dim. cm.
52550-01	25,5



Sauce ladle

Coppino salsa
Dressingschöpfer
Louche à sauce
Cazillo salsas

art.	dim. cm.
52550-20	16



Perforated sauce ladle

Coppino forato
Dressingschöpfer, gelocht
Louche à sauce percée
Cazillo, perforado

art.	dim. cm.
52550-21	16,5



Spaghetti serving fork

Forchettone spaghetti
Spaghettivorlegegabel
Fourchette à servir spaghetti
Tenedor servir espagueti

art.	dim. cm.
52550-15	28,5



Rice ladle

Cucchiaio risotto
Reislöffel
Cuiller à risotto
Cuchara arroz

art.	dim. cm.
52550-16	28



Meat fork

Forchettone
Tranchiergabel
Fourchette
Tenedor

art.	dim. cm.
52550-30	32



Roast beef knife

Coltello arrosto
Tranchiermesser
Couteau à rôtis
Cuchillo roastbeef

art.	dim. cm.
52550-33	32



Butter spreader

Spatolina burro
Butterstreicher
Tarnineur
Palita mantequilla

art.	dim. cm.	U. Pack
52550-37	16,5	6



Salt spoon

Cucchiaino sale
Salzlöffel
Cuiller à sel
Cucharita para sal

art.	dim. cm.	U. Pack
52550-17	6,5	6



Parmesan spoon

Cucchiaio parmigiano
Parmesanlöffel
Cuiller à parmesan
Cucharita parmesano

art.	dim. cm.	U. Pack
52550-18	12,5	6



Ice tea spoon
Cucchiaio bibita
Limonadenlöffel
Cuillère à soda
Cuchara refresco

art.	dim. cm.	U. Pack
52550-36	19,5	6



Oyster fork
Forchettina ostriche
Austerngabel
Fourchette à huîtres
Tenedor ostras

art.	dim. cm.	U. Pack
52550-43	14	6



Escargot fork
Forchetta per lumache
Schneckengabel
Fourchette à escargots
Tenedor caracoles

art.	dim. cm.	U. Pack
52550-19	14	6



Ice tea spoon
Cucchiaio bibita
Limonadenlöffel
Cuillère à soda
Cuchara refresco

art.	dim. cm.	U. Pack
41605-25	25	6



Ice spoon
Cucchiaio ghiaccio
Eislöffel
Cuillère à glace
Cuchara hielo

art.	dim. cm.
52550-04	22



Dressing spoon
Cucchiaio salsa
Saucenlöffel
Cuillère à sauce
Cuchara salsa

art.	dim. cm.
52550-06	22



Monoportion spoon
Cucchiaio monoporzione
Monoporzion-Löffel
Cuillère monoportion
Cuchara monoporción

art.	dim. cm.	U. Pack
52550-03	9,5	6
52550-07	12,0	6



Monoportion fork
Forchetta monoporzione
Monoporzion-Gabel
Fourchette monoportion
Tenedor monoporción

art.	dim. cm.	U. Pack
52550-05	9,5	6



Monoportion fork
Forchetta monoporzione
Monoporzion-Gabel
Fourchette monoportion
Tenedor monoporción

art.	dim. cm.	U. Pack
52550-09	12	6



FINE MELAMINE SERIES PORTRAIT

TABLE TOP
TAVOLA



Portrait reinterpreta in chiave contemporanea l'eleganza e il fascino del periodo rococò. Ideale per un buffet all'aperto, una pranzo a bordo piscina o un momento di relax nella SPA di un hotel, Portrait aggiunge un tocco di classe in tutte le situazioni.

Withstands temperatures from -20°C to +70°C.

Portrait reinterprets the elegance and charm of the Rococo period in a contemporary key. Ideal for an outdoor buffet, a poolside lunch or a relaxing moment in a hotel SPA, Portrait adds a touch of class in every situation.

Termoresistenti da -20°C a +70°C.



Flat Plate

Piatto Piano
Teller flach
Assiette Plate
Plato Llano

art.	Ø cm.	U. Pack	col.
68101W01	21	6	○
68101W02	27	6	○
68101W03	32	6	○



Soup Plate

Piatto Fondo
Teller tief
Assiette Creuse
Plato Hondo

art.	Ø cm.	U. Pack	col.
68101W09	24	6	○



Rectangular Plate

Piatto Rettangolare
Platte rechteckig
Assiette Rectangulaire
Plato Rectangular

art.	dim. cm.	U. Pack	col.
68101W29	34X24x1,7	1	○
68101W30	53X32x1,7	1	○



Rectangular Plate, Deep

Piatto Rettangolare Fondo
Platte rechteckig, tief
Assiette Rectangulaire, Creuse
Plato Rectangular, Hondo

art.	dim. cm.	U. Pack	col.
68101W32	34X24x1,9	1	○
68101W33	53X32x1,9	1	○



Party Tray

Vassoio Party
Party Platte
Plateau Party
Bandeja Party

art.	Ø cm.	U. Pack	col.
68101W35	21	6	○



Bowl

Ciotola/Insalatiera
Schüssel
Bol/Saladier
Bol Ensalada

art.	Ø cm.	h. cm.	U. Pack	col.
68101W81	11	5,5	6	○
68101W82	19	7,5	1	○
68101W83	22	9,5	1	○
68101W84	32	11,5	1	○



Flat Plate

Piatto Piano
Teller flach
Assiette Plate
Plato Llano

art.	Ø cm.	U. Pack	col.
68101L01	21	6	●
68101L02	27	6	●
68101L03	32	6	●



Soup Plate

Piatto Fondo
Teller tief
Assiette Creuse
Plato Hondo

art.	Ø cm.	U. Pack	col.
68101L09	24	6	●



Rectangular Plate

Piatto Rettangolare
Platte rechteckig
Assiette Rectangulaire
Plato Rectangular

art.	dim. cm.	U. Pack	col.
68101L29	34X24x1,7	1	●
68101L30	53X32x1,7	1	●





Rectangular Plate, Deep

Piatto Rettangolare Fondo
Platte rechteckig, tief
Assiette Rectangulaire, Creuse
Plato Rectangular, Hondo

art.	dim. cm.	U. Pack	col.
68101L32	34X24x1,9	1	●
68101L33	53X32x1,9	1	●



Party Tray

Vassoio Party
Party Platte
Plateau Party
Bandeja Party

art.	Ø cm.	U. Pack	col.
68101L35	21	6	●



Bowl

Ciotola/Insalatiera
Schüssel
Bol/Saladier
Bol Ensalada

art.	Ø cm.	h. cm.	U. Pack	col.
68101L81	11	5,5	6	●
68101L82	19	7,5	1	●
68101L83	22	9,5	1	●
68101L84	32	11,5	1	●



Flat Plate

Piatto Piano
Teller flach
Assiette Plate
Plato Llano

art.	Ø cm.	U. Pack	col.
68101D01	21	6	●
68101D02	27	6	●
68101D03	32	6	●



Soup Plate

Piatto Fondo
Teller tief
Assiette Creuse
Plato Hondo

art.	Ø cm.	U. Pack	col.
68101D09	24	6	●



Rectangular Plate

Piatto Rettangolare
Platte rechteckig
Assiette Rectangulaire
Plato Rectangular

art.	dim. cm.	U. Pack	col.
68101D29	34X24x1,7	1	●
68101D30	53X32x1,7	1	●



Rectangular Plate, Deep

Piatto Rettangolare Fondo
Platte rechteckig, tief
Assiette Rectangulaire, Creuse
Plato Rectangular, Hondo

art.	dim. cm.	U. Pack	col.
68101D32	34X24x1,9	1	●
68101D33	53X32x1,9	1	●



Party Tray

Vassoio Party
Party Platte
Plateau Party
Bandeja Party

art.	Ø cm.	U. Pack	col.
68101D35	21	6	●



Bowl

Ciotola/Insalatiera
Schüssel
Bol/Saladier
Bol Ensalada

art.	Ø cm.	h. cm.	U. Pack	col.
68101D81	11	5,5	6	●
68101D82	19	7,5	1	●
68101D83	22	9,5	1	●
68101D84	32	11,5	1	●

BLACK & BROWN - FEELS LIKE CLAY
NERO & MARRONE - SENSAZIONE D'ARGILLA



Black with brown edges. - Nero con bordi marrone.

An imitation of clay, with a brown border. The surface is inside and outside fine-matt. Feels like real clay. - Una perfetta imitazione di argilla, con bordo marrone. Superficie interna ed esterna finemente opaca e con effetto argilla al tatto.



Bowl
Ciotola
Schüssel
Bol

art.	dim. cm.	lt.
44480-00	25,5x14x5,5	0,4
44480-01	36x19x8	0,9



Tray
Vassoio
Tablett
Plateau
Bandeja

art.	dim. cm.
44480-03	14,5x14,5x2



Tray
Vassoio
Tablett
Plateau
Bandeja

art.	dim. cm.
44480-04	22,5x15x3
44480-05	27,5x11x2



Tray
Vassoio
Tablett
Plateau
Bandeja

art.	dim. cm.
44480-06	26,5x16,5x4



Bowl
Ciotola
Schüssel
Bol

art.	Ø cm.	h. cm.	lt.
44480-07	8,5	2,5	0,05



Bowl
Ciotola
Schüssel
Bol

art.	Ø cm.	h. cm.	lt.
44480-08	11,5	3	0,04



Bowl
Ciotola
Schüssel
Bol

art.	Ø cm.	h. cm.	lt.
44480-09	11	5,5	0,2



Bowl
Ciotola
Schüssel
Bol

art.	Ø cm.	h. cm.	lt.
44480-10	14	6,0	0,3
44480-11	19	8,0	0,8
44480-12	21	8,5	1,0
44480-13	24	9,5	1,4



Bowl
Ciotola
Schüssel
Bol

art.	dim. cm.	lt.
44480-14	23,5x23,5x6,5	0,7



Bowl
Ciotola
Schüssel
Bol
Bol

art.	Ø cm.	h. cm.	lt.
44480-15	11	3,5	0,13
44480-16	14	4,0	0,20
44480-20	30,5	8,5	2,00



Tray
Vassoio
Tablett
Plateau
Bandeja

art.	dim. cm.
44480-17	19,5x9,5x2
44480-18	39x16x3



Tray
Vassoio
Tablett
Plateau
Bandeja

art.	dim. cm.
44480-19	32,5x23,5x4,5



Soup plate
Piatto fondo
Teller tief
Assiette creuse
Plato hondo

art.	Ø cm.	h. cm.	lt.	col.
44478-20	20,5	3	0,5	●



Soup plate
Piatto fondo
Teller tief
Assiette creuse
Plato hondo

art.	Ø cm.	h. cm.	lt.	col.
44478-21	20,5	3	0,5	●



Flat plate
Piatto piano
Teller flach
Assiette plate
Plato llano

art.	dim. cm.	col.
44478-22	14x13x2,5	●



Flat plate
Piatto piano
Teller flach
Assiette plate
Plato llano

art.	dim. cm.	col.
44478-23	14x13x2,5	●



Bowl
Ciotola
Schüssel
Bol
Bol

art.	Ø cm.	h. cm.	lt.	col.
44478-24	12,5	6	0,37	●
44478-26	16	7	0,70	●



Bowl
Ciotola
Schüssel
Bol
Bol

art.	Ø cm.	h. cm.	lt.	col.
44478-25	12,5	6	0,37	●
44478-27	16	7	0,70	●



Bowl
Ciotola
Schüssel
Bol
Bol

art.	Ø cm.	h. cm.	lt.	col.
44478-28	16,5	4	0,5	●



Bowl
Ciotola
Schüssel
Bol
Bol

art.	Ø cm.	h. cm.	lt.	col.
44478-29	16,5	4	0,5	●



Bowl
Ciotola
Schüssel
Bol
Bol

art.	Ø cm.	h. cm.	lt.	col.
44478-30	21	8	1,45	●



Bowl
Ciotola
Schüssel
Bol
Bol

art.	Ø cm.	h. cm.	lt.	col.
44478-31	21	8	1,45	●



Bowl
Ciotola
Schüssel
Bol
Bol

art.	dim. cm.	lt.	col.
44478-32	30,5x10x7,5	0,17	●
44478-34	42x14x9,5	0,65	●



Bowl
Ciotola
Schüssel
Bol
Bol

art.	dim. cm.	lt.	col.
44478-33	30,5x10x7,5	0,17	●
44478-35	42x14x9,5	0,65	●

TABLE TOP TAVOLA

SERVING ITEMS
COMPLEMENTI



FINGERFOOD



Oval tweested dish
Ovalina goccia

art. dim. cm.
41200-01 9x5x3



Eye dish
Ovalina occhio

art. dim. cm.
41200-02 8,1x5,6x3



Egg dish
Tegamino 2/m

art. dim. cm.
41200-03 8,5x6,8x2



Oval dish
Ovalina

art. dim. cm.
41200-04 10x5,5x2,7



Soya sauce dish
Rettangolare

art. dim. cm.
41200-05 8x5,5x1,8



Square dish
Piattino quadro

art. dim. cm.
41200-06 8x8x2,4



Oriental square dish
Quadrato orientale

art. dim. cm.
41200-07 7,5x7,5x3



Dye dish
Cubo

art. dim. cm.
41200-08 5,2x5,2x4



Chao dish
Quadrato punte

art. dim. cm.
41200-09 8x8x5



Tear dish
Foglia

art. dim. cm.
41200-10 8x7x3,4



Nem dish
Tronchetto

art. dim. cm.
41200-11 5,5x4,5x6,5



Rectangular w/lid
Rettangolare c/cop

art. dim. cm.
41200-13 10x5,5x4,5



Square pan with lid
Quadra c/cop

art. dim. cm.
41200-14 9x3,6x4,5



Oval pan with lid
Ovale c/cop

art. dim. cm.
41200-15 10,5x7x4,5



Rectangular pan
Casseruola rett.

art. dim. cm.
41200-16 10x5,5x4,5



Square pan
Casseruola quadra

art. dim. cm.
41200-17 9x3,6x4,5



Oval pan

Casseruola ovale

art. dim. cm.
41200-18 10,5x7x4,5



Footed square dish

Quadrato

art. dim. cm.
41200-32 10x10x1,2



Fish dish

Piattino pesce

art. dim. cm.
41200-33 10,5x5x1,6



Small pan

Tegamino

art. dim. cm.
41200-34 9,7x6x2,6



Mini pasta bowl

Mini ciotola pasta

art. dim. cm.
41200-36 10x2,5x1,6



Square dish

Coppetta quadra

art. dim. cm.
41200-40 7x7x3,5



Round bowl

Bolo tondo

art. Ø cm. h. cm.
41200-41 7 4,5



Small pot

Mini pentola

art. dim. cm.
41200-49 5x5x5



Small bucket

Secchiello

art. dim. cm.
41200-50 6x6x4,5



Colander

Colapasta

art. dim. cm.
41200-51 7x7x4,5



Fruit case

Cassetta frutta

art. dim. cm.
41200-52 8x5,5x2,3



Tin with lid

Scatoletta c/cop

art. dim. cm.
41200-53 13,5x5,5x5



Tin with lid

Scatoletta c/cop

art. Ø cm. h. cm.
41200-54 13,5 4



French fries bowl

Vaschetta patatine

art. dim. cm.
41200-58 13x10x4



Rectangular w/handles

Rettangolare c/m

art. dim. cm.
41200-59 14x10x3,5



Rectangular lid

Coperchio rett.

art. dim. cm.
41200-60 14x10



Oval w/handles

Ovale c/m

art. dim. cm.
41200-61 14x9,5x3,5



Oval lid

Coperchio ovale

art. dim. cm.
41200-62 14x9,5



Round w/handles

Tonda c/m

art. Ø cm. h. cm.
41200-63 13 5,5



Round lid

Coperchio tondo

art. Ø cm.
41200-64 13



Ramequin

Ramequin

art. Ø cm. h. cm.
41200-46 10 5,0
41200-47 9 5,0
41200-48 8 4,5



Vintage tray

Vassoietto vintage

art. dim. cm.
41200-55 15x10x1,7



Vintage tray

Vassoietto vintage

art. dim. cm.
41200-56 22,3x14x2



Vintage tray

Vassoietto vintage

art. dim. cm.
41200-57 29,5x20,5x2



SS

Insulated beverage server

Caraffa termica
Thermokanne
Pot isotherme
Jarra térmica

art.	lt.
41650-06	0,6
41650-10	1,0
41650-13	1,5



SS

Insulated beverage server

Caraffa termica
Thermokanne
Pot isotherme
Jarra térmica

art.	lt.
41646-06	0,6
41646-10	1,0
41646-15	1,5
41646-20	2,0



SS

Insulated beverage server

Caraffa termica
Thermokanne
Pot isotherme
Jarra térmica

art.	lt.
42401-10	1,0
42401-15	1,5
42401-20	2,0



SS

Insulated beverage server

Caraffa termica
Thermokanne
Pot isotherme
Jarra térmica

art.	lt.
42405-10	1
42405-20	2



SS

PP

Insulated beverage server

Caraffa termica
Thermokanne
Pot isotherme
Jarra térmica

art.	Ø cm.	h. cm.	lt.
42403-01	16	20	1

8 cups. – 8 tazze.



SS

PP

Insulated beverage server

Caraffa termica
Thermokanne
Pot isotherme
Jarra térmica

art.	Ø cm.	h. cm.	lt.
42403B01	16	20	1

8 cups. – 8 tazze.



NEW

French press

Caffettiera pressa filtro
Kaffeebereiter
Cafetière à piston
Jarra para infusiones

art.	ml.
41640-03	300
41640-06	600
41640-08	800



PC

Water jug

Caraffa
Wasserkrug
Crûche à eau
Jarra

art.	Ø cm.	h. cm.	lt.
44999-09	10	15	0,9
44999-16	12	20	1,6



PC

PP

Water jug

Caraffa
Wasserkrug
Crûche à eau
Jarra

art.	lt.
44871-30	1
44871-31	lid/cop



PC

PP



Water jug
Caraffa
Wasserkrug
Crûche à eau
Jarra

art.	Ø cm.	h. cm.	lt.
44992-03	26	29	3



Water jug
Caraffa
Wasserkrug
Crûche à eau
Jarra

art.	Ø cm.	h. cm.	lt.
44994-00	14	29	2,5



Water jug
Caraffa
Wasserkrug
Crûche à eau
Jarra

art.	Ø cm.	h. cm.	lt.
44992-02	16,5	26	2



Juice pitcher, glass
Caraffa vetro
Glas-Saftkanne
Carafe à jus de fruits, verre
Jarra zumo, vidrio

art.	Ø cm.	h. cm.	lt.
44995-15	9,5	27	1,5

Stainless steel lid. – Coperchio inox. -10°C/+110°C



Juice pitcher, glass
Caraffa vetro
Glas-Saftkanne
Carafe à jus de fruits, verre
Jarra zumo, vidrio

art.	Ø cm.	h. cm.	lt.
44995-14	16	27	1,4

Spout opens and closes automatically. Chromed foot with cooler, keep drinks chilled up to 4 hours. – Tappo apre e chiude automaticamente. Piede cromato con eutettico, mantiene le bevande refrigerate fino a 4 ore.



Juice pitcher, glass
Caraffa vetro
Glas-Saftkanne
Carafe à jus de fruits, verre
Jarra zumo, vidrio

art.	Ø cm.	h. cm.	lt.
44995-10	9,5	29	1

Spout opens and closes automatically while serving. – Tappo versatore apre e chiude automaticamente.



Juice pitcher with lid
Caraffa con coperchio
Saftkanne mit Deckel
Carafe à jus avec couvercle
Jarra zumo con tapa

art.	Ø cm.	h. cm.	lt.
44993-01	11	30	1,6



Tea strainer
Passathé
Teesieb
Passoire à thé
Colador de tè

art.	Ø cm.
41529-05	5



Tea strainer
Passathé
Teesieb
Passoire à thé
Colador de tè

art.	Ø cm.
41530-05	5



Tea strainer
Passathé
Teesieb
Passoire à thé
Colador de tè

art.	Ø cm.
41530-11	5



Tea strainer
Passathé
Teesieb
Passoire à thé
Colador de tè

art.	Ø cm.
41530-07	7,5



Tea strainer
Passathé
Teesieb
Passoire à thé
Colador de tè

art.	Ø cm.
42617-04	4,5
42617-05	5,0
42617-06	6,5
42617-07	7,5



SS

Toast rack
Portatoast
Toastständer
Support pour toast
Porta tostadas

art. dim. cm.
41599-08 20x11x5,7



SS

Egg cup
Portauovo
Eierbecher
Coquetier
Soporte huevos

art. Ø cm.
41598-00 8,5



MF

Egg cup, set 4 pcs
Portauovo, set 4 pz
Eierbecher, 4 Stk.
Coquetier, set 4 pcs
Soporte huevos, set 4 pz

art. Ø cm.
41597-04 8,5

NATURAL SLATE ARDESIA NATURALE



Excellent coldness retention, food safe. The edges of the trays are broken to show the typical structure of the natural material. With anti-slip feet. No dishwasher proof. Material thickness: 4-7 mm.

Eccellente immagazzinamento del freddo, idonei al contatto alimentare. Gli angoli dei piani sono spezzati per evidenziare la tipica struttura del materiale. Con piedini antiscivolo. Non idonei al lavaggio in lavastoviglie. Spessore: 4-7 mm.



Tray
Vassoio
Platte
Plateau
Placa

art. dim. cm.
41585-37 20x10



Tray
Plancia
Platte
Plateau
Placa

art. GN dim. cm.
41585-11 1/1 53x32,2
41585-12 1/2 32,5x26,5
41585-13 1/3 32,5x17,5
41585-24 1/4 26,5x16,5
41585-23 2/4 53x16,2



Square tray
Plancia quadra
Platte, viereckig
Plateau carré
Placa cuadrada

art. dim. cm.
41585-25 25x25
41585-30 30x30



Rectangulat tray

Plancia rettangolare
Platte, rechteckig
Plateau rectangulaire
Placa rectangular

art.	dim. cm.
41585-45	45x30



Round tray

Plancia tonda
Platte, rund
Plaque ronde
Placa redonda

art.	Ø cm.
41586-22	22
41586-28	28
41586-33	33
41586-38	38



Square tray, 4 pcs set

Plancia quadra, set 4 pz
Platte, viereckig, Satz 4 Stk
Plateau carré, set 4 pcs
Placa cuadrada, juego 4 pz

art.	dim. cm.
41585-10	10x10



Tray with holes

Vassoio con fori
Platte mit Absätze
Plat avec trous
Placa con agujeros

art.	Ø cm.	dim. cm.
41585-01	3,5	25x12



Tray with holes

Vassoio con fori
Platte mit Absätze
Plat avec trous
Placa con agujeros

art.	Ø cm.	dim. cm.
41585-02	6	15x8



Tray with holes

Vassoio con fori
Platte mit Absätze
Plat avec trous
Placa con agujeros

art.	Ø cm.	dim. cm.
41585-03	2,5	28x10



Tray with dome

Piatto con campana
Platte mit Glashaube
Plat avec cloche
Bandeja y campana de cristal

art.	Ø cm.	h. cm.
41585-00	10,5	8



2 tier tray

Alzata 2 piani
2-stufige Etagère
Présentoir 2 niveaux
Bandeja dos niveles

art.	Ø cm.	h. cm.
41587-25	20-25	24



Revolving platter

Supporto girevole
Servierplatt, drehbar
Présentoir tournant
Soporte rotatorio

art.	Ø cm.	h. cm.
41587-32	32	2,5



Tray

Plancia
Platte
Plateau
Placa

art.	dim. cm.	fits/per
41585-51	24x15	44842-30
41585-52	47x10	44843-24
41585-53	26,5x20,5	44843-12
41585-54	32x12	44842-35

41585-52 + 44843-24



41585-54 + 44842-35



41585-53 + 44843-12



41585-51 + 44842-30



**TABLE TOP TAVOLA
SERVING ITEMS COMPLEMENTI**

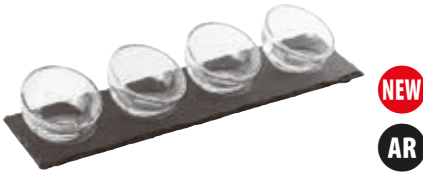

NEW
AR

5 pcs tasting/dessert set
Set 5 pz aperitivo/degustazione
5 Stück Verkostung/Dessert Set
Set 5 pcs dégustation/dessert
Juego de degustación/postre 5 pz
.....
art. dim. cm. ml.
41205-01 35x10 4x43



NEW
AR

5 pcs tasting/dessert set
Set 5 pz aperitivo/degustazione
5 Stück Verkostung/Dessert Set
Set 5 pcs dégustation/dessert
Juego de degustación/postre 5 pz
.....
art. dim. cm. ml.
41205-02 35x10 4x110



NEW
W

5 pcs tasting/dessert set
Set 5 pz aperitivo/degustazione
5 Stück Verkostung/Dessert Set
Set 5 pcs dégustation/dessert
Juego de degustación/postre 5 pz
.....
art. dim. cm. ml.
41205-03 49x9,7x1,8 4x176



NEW
W

4 pcs tasting/dessert set
Set 4 pz aperitivo/degustazione
4 Stück Verkostung/Dessert Set
Set 4 pcs dégustation/dessert
Juego de degustación/postre 4 pz
.....
art. dim. cm. ml.
41205-04 35x11x1,8 3x147



NEW
W

4 pcs tasting/dessert set
Set 4 pz aperitivo/degustazione
4 Stück Verkostung/Dessert Set
Set 4 pcs dégustation/dessert
Juego de degustación/postre 4 pz
.....
art. dim. cm. ml.
41205-05 45x11x1,8 3x147



NEW
W

5 pcs tasting/dessert set
Set 5 pz aperitivo/degustazione
5 Stück Verkostung/Dessert Set
Set 5 pcs dégustation/dessert
Juego de degustación/postre 5 pz
.....
art. dim. cm.
41205-06 45x9x1,8



NEW
W

5 pcs tasting/dessert set
Set 5 pz aperitivo/degustazione
5 Stück Verkostung/Dessert Set
Set 5 pcs dégustation/dessert
Juego de degustación/postre 5 pz
.....
art. dim. cm. ml.
41205-07 42x9x1,8 4x68



NEW
W

4 pcs canning Jar set
Set 4 pz barattoli degustazione
4 Stück Verkostung-Gläser Set
Set 4 pcs dégustation/dessert
Juego de degustación/postre 4 pz
.....
art. dim. cm. ml.
41205-08 27,5x11x4 3x200



NEW
W

7 pcs canning Jar set
Set 7 pz barattoli degustazione
5 Stück Verkostung-Gläser Set
Set 7 pcs dégustation/dessert
Juego de degustación/postre 5 pz
.....
art. dim. cm. ml.
41205-09 43x10x3 6x100



NEW
W

4 pcs tasting/dessert set
Set 4 pz aperitivo/degustazione
4 Stück Verkostung/Dessert Set
Set 4 pcs dégustation/dessert
Juego de degustación/postre 4 pz
.....
art. dim. cm.
41205-10 35x11x2



GLASS JARS
VASETTI WECK



Perfect for the sterilization and pasteurization of any product, fruit, vegetables, but also meat, fish, foie gras or delicatessen products. They are suitable for serving jams and sauces: they also look beautiful on the table. They are perfect for cooking and serving on the table. They are 100% pure glass, so they do not release harmful substances into food, they resist very high temperatures (up to 200°C in the oven), they can be washed in the dishwasher (including seal).

Perfetti per la sterilizzazione e la pastorizzazione di qualsiasi prodotto, di frutta verdura ma anche di carne, pesce, foie gras o prodotti di salumeria. Sono indicati per servire marmellate e salse di accompagnamento: inoltre belli da vedere sulla tavola. Sono i vasetti perfetti per la vasocottura e per servire in tavola. Sono al 100% in puro vetro, quindi non rilasciano sostanze nocive nel cibo, resistono a temperature elevatissime (fino a 200°C in forno), si possono lavare in lavastoviglie (guarnizione compresa).



Set 12 glasses and cover

Set 12 vasetti con coperchio
Gläser mit Deckel, 12er Set
Set 12 verres avec couvercle
12 vasos con tapa

art.	Ø cm.	h. cm.	ml.
41589-08	6	5,5	80
41589-14	6	7,0	140



Set 12 glasses and cover

Set 12 vasetti con coperchio
Gläser mit Deckel, 12er Set
Set 12 verres avec couvercle
12 vasos con tapa

art.	Ø cm.	h. cm.	ml.
41589-16	6	8	160



Set 12 glasses and cover

Set 12 vasetti con coperchio
Gläser mit Deckel, 12er Set
Set 12 verres avec couvercle
12 vasos con tapa

art.	Ø cm.	h. cm.	ml.
41589-22	7	8	220



Set 12 glasses and cover

Set 12 vasetti con coperchio
Gläser mit Deckel, 12er Set
Set 12 verres avec couvercle
12 vasos con tapa

art.	Ø cm.	h. cm.	ml.
41589-20	9	6	200



Set 2 glasses and cover

Set 2 vasetti con coperchio
Gläser mit Deckel, 2er Set
Set 2 verres avec couvercle
2 vasos con tapa

art.	Ø cm.	h. cm.	ml.
41589-58	11	11	580



Set 3 glasses and cover

Set 3 vasetti con coperchio
Gläser mit Deckel, 3er Set
Set 3 verres avec couvercle
3 vasos con tapa

art.	Ø cm.	h. cm.	ml.
41589-37	11	7,5	370



Set 6 bottles and cover

Set 6 bottigliette con coperchio
Flaschen mit Deckel, 6er Set
Set 6 bouteilles avec couvercle
6 botellas con tapa

art.	Ø cm.	h. cm.	ml.
41589-25	6,5	14,5	250



Set 6 bottles and cover

Set 6 bottigliette con coperchio
Flaschen mit Deckel, 6er Set
Set 6 bouteilles avec couvercle
7 botellas con tapa

art.	Ø cm.	h. cm.	ml.
41589-50	6,5	19	500



Set 6 bottles and cover

Set 6 bottigliette con coperchio
Flaschen mit Deckel, 6er Set
Set 6 bouteilles avec couvercle
8 botellas con tapa

art.	Ø cm.	h. cm.	ml.
41589-99	6,5	25,5	1000



Set 10 rubber rings

Set 10 guarnizioni
Gummidichtringe, 10er Set
Set 10 joints
Juego 10 juntas

art.	Ø cm.	fits/per
41589-AA	6	41589-08-14-16
41589-BB	9	41589-20
41589-CC	11	41589-37-58



Set 5 airtight covers

Set 5 coperchi ermetici
Frischhaltedeckel, 5er Set
Set 5 couvercles hermétiques
Juego 5 tapas herméticas

art.	Ø cm.	fits/per
41589-AC	7	41589-08-14-16
41589-AC	7	41589-25-50-99



Set 8 cover clamps

Set 8 clip
Deckel-Klammer 8er Set
Set 8 clips crochets
Juego 8 abrazaderas

art.
41589-AB



Set 12 glasses (without lid)

Set 12 vasetti (senza coperchi)
Gläser, 12er Set (ohne Deckel)
Set 12 verres (sans couvercle)
Juego 12 vasos (sin tapa)

art.	Ø cm.	h. cm.	ml.
41589C08	6	5,5	80
41589C16	6	8,0	160



Serving stand, chrome plated

Supporto cromato
Serviergestell, hartverchromt
Présentoir, acier chromé
Soporte, acero cromado

art.	Ø cm.	h. cm.	fits/per
44840-28	22	33	41589-08

Without glasses. – Senza vasetti.



Serving stand, chrome plated

Supporto cromato
Serviergestell, hartverchromt
Présentoir, acier chromé
Soporte, acero cromado

art.	Ø cm.	h.	fits/per
44840-27	22	59	41589-08-14-16

Without glasses. – Senza vasetti.

SS



TRAYS
VASSOI PLANK



In reinforced polyester, suitable for food contact, dishwasher safe. Natural rough finish and elegant at the same time. They can be used as showplate and as presentation tray as well. Available in 3 colors. Non-slip foot available on request item 41323-AA.

Plance in poliestere rinforzato, idoneo al contatto alimentare, lavabile in lavastoviglie. Finitura ruvida naturale ed elegante al tempo stesso. Possono essere utilizzate come piatto presentazione e come vassoi espositivi. Disponibili in 3 colorazioni. Piedini antiscivolo in opzione art. 41323-AA.



Tray, rectangular
Plancia rettangolare
Platte, rechteckig
Plateau rectangulaire
Placa rectangular

art.	dim. cm.	col.
41323-11	30x20x0,5	●
41323-12	40x20x0,5	●
41323-13	40x30x0,5	●
41323-14	60x40x0,5	●



Tray, rectangular
Plancia rettangolare
Platte, rechteckig
Plateau rectangulaire
Placa rectangular

art.	dim. cm.	col.
41323-21	30x20x0,5	●
41323-22	40x20x0,5	●
41323-23	40x30x0,5	●
41323-24	60x40x0,5	●



Tray, rectangular
Plancia rettangolare
Platte, rechteckig
Plateau rectangulaire
Placa rectangular

art.	dim. cm.	col.
41323-01	30x20x0,5	●
41323-02	40x20x0,5	●
41323-03	40x30x0,5	●
41323-04	60x40x0,5	●



Tray, round
Plancia rotonda
Platte, rund
Plateau ronde
Placa redonda

art.	Ø cm.	h. cm.	col.
41323-16	30	0,5	●
41323-17	38	0,5	●
41323-18	40	0,5	●



Tray, round
Plancia rotonda
Platte, rund
Plateau ronde
Placa redonda

art.	Ø cm.	h. cm.	col.
41323-26	30	0,5	●
41323-27	38	0,5	●
41323-28	40	0,5	●



Tray, round
Plancia rotonda
Platte, rund
Plateau ronde
Placa redonda

art.	Ø cm.	h. cm.	col.
41323-06	30	0,5	●
41323-07	38	0,5	●
41323-08	40	0,5	●



NEW



Tray support

Supporto per vassoio
Tablett Unterstützung
Support pour plateaux
Soporte para bandejas

art. dim. cm.
41323-99 5x5x6



**TRAYS WOOD EFFECT
VASSOI EFFETTO LEGNO**



MF



NEW



Rectangular platter

Vassoio rettangolare
Tablett, Rechteckig
Plateau rectangulaire
Bandeja rectangular

art. dim. cm.
44473-31 53x32,5x0,8
44473-32 32,5x26,5x0,8
44473-34 26x16x0,8
44473-33 32,5x17,5x0,8



NEW

Round platter

Vassoio rotondo
Tablett, Rund
Plateau rond
Bandeja redonda

art. Ø cm. h. cm.
44473-02 33 0,8
44473-03 43 0,8



NEW

Round platter with handle

Vassoio rotondo con manico
Tablett, Rund mit Griff
Plateau rond avec manche
Bandeja redonda con mango

art. Ø cm. h. cm.
44473-05 38 1,5



NEW

Rectangular platter with handle
Vassoio rettangolare con manico
Tablett Rechteckig mit Griff
Plateau rectangulaire avec manche
Bandeja rectangular con mango

art. dim. cm.
44473-07 53x20x1,5



NEW

Rectangular platter with handle
Vassoio rettangolare con manico
Tablett Rechteckig mit Griff
Plateau rectangulaire avec manche
Bandeja rectangular con mango

art. dim. cm.
44473-08 61x20x1,5



GN

Tray, rectangular
Plancia rettangolare
Platte, rechteckig
Plateau rectangulaire
Placa rectangular

art. dim. cm.
44471-11 53x32,5x1,5
44471-12 32,5x26,5x1,5
44471-13 32,5x17,6x1,5
44471-14 26,5x16,2x1,5
44471-24 53x16,2x1,5

WOODEN SERVING BOARDS
TAGLIERI IN LEGNO



Each piece is carefully handcrafted therefore size, shape and finish may vary from piece to piece. Wash by hand with warm soapy water, do not to soak.

Ogni pezzo è realizzato a mano quindi dimensioni, forma e finitura variano da pezzo a pezzo. Lavare a mano con acqua tiepida e sapone. Non mettere in ammollo.



NEW

W

Serving board
Tagliere
Servier-Brett
Planche de service
Tabla

art. dim. cm.
41327-01 45,5x20



NEW

W

Bowl
Ciotola
Schüssel
Bol
Bol

art. Ø cm.
41327-02 25,5



NEW

W

Serving board
Tagliere
Servier-Brett
Planche de service
Tabla

art. Ø cm.
41327-03 20,0
41327-04 25,5
41327-05 30,5



W

Serving board

Tagliere
Servier-Brett
Planche de service
Tabla

art.	dim. cm.
41320-25	25x17x1,5
41320-30	30x20,5x2
41320-35	35x24x2

Olive wood. – Ulivo.



W

Serving board

Tagliere
Servier-Brett
Planche de service
Tabla

art.	dim. cm.	l. cm.
41321-40	40x15x1,5	40+11
41321-44	44x20x2	44+12

Olive wood. – Ulivo.



W

Serving board

Tagliere
Servier-Brett
Planche de service
Tabla

art.	dim. cm.	l. cm.
41322-19	19x12,2x1,5	19+6
41322-25	25x16x1,5	25+8
41322-31	31x20x1,5	31+9

Olive wood. – Ulivo.



W

Serving board

Tagliere
Servier-Brett
Planche de service
Tabla

art.	dim. cm.
41325-20	20x12x3

Birch wood. – Betulla.



W

Serving board

Tagliere
Servier-Brett
Planche de service
Tabla

art.	dim. cm.
41325-30	30x20x3

Birch wood. – Betulla.



W

Serving board

Tagliere
Servier-Brett
Planche de service
Tabla

art.	dim. cm.
41325-40	40x15x3

Birch wood. – Betulla.



AR

W

Serving board

Tagliere
Servier-Brett
Planche de service
Tabla

art.	dim. cm.
41326-30	30,5x13x1,5

Acacia wood. – Acacia.



AR

W

Serving board

Tagliere
Servier-Brett
Planche de service
Tabla

art.	dim. cm.
41326-36	36,5x15x1,5

Acacia wood. – Acacia.



AR

W

Serving board

Tagliere
Servier-Brett
Planche de service
Tabla

art.	dim. cm.
41326-42	42x18x1,5

Acacia wood. – Acacia.



SS

PR

Mustard cup

Senapiera
Sensschale
Moutardier
Mostacero

art.	Ø cm.
41564-07	7



SS

PR

Butter cup

Coppa burro
Butterservierer
Coupe à beurre
Copa mantequilla

art.	Ø cm.
41563-07	7



SS

PR

Butter cup

Coppa burro
Butterservierer
Coupe à beurre
Copa mantequilla

art.	Ø cm.
41561-09	9



SS

Insulated sauce boat

Salsiera termica
Thermo-Sauciere, doppelwandig
Saucière isotherme
Salsiera termica

art.	dim. cm.	lt.
41620-04	19x12,5x13	0,4



SS

Gravy boat with foot

Salsiera
Salsiera mit Fuss
Saucière sur pied
Salsiera con pie

art.	lt.
41615-01	0,15
41615-03	0,25
41615-05	0,45



PR

Soup bowl

Zuppiera testa di leone
Suppentasse Löwenkopf
Soupière tête de lion
Sopera cabeza de león

art.	Ø cm.	lt.
44379-05	17	0,5



PC

Salad bowl

Insalatiera
Salatschüssel
Saladier
Bol para ensalada

art.	Ø cm.	h. cm.	lt.
44950-15	15,2	5,0	0,6
44950-20	20,3	6,5	1,7
44950-25	25,4	8,0	3,0
44950-30	30,5	10,0	5,5
44950-38	38,1	12,5	10,6



PC

Salad bowl

Insalatiera
Salatschüssel
Saladier
Bol para ensalada

art.	dim. cm.
44357-10	24x24x10
44357-15	24x24x15



PC

Salad bowl

Insalatiera
Salatschüssel
Saladier
Bol para ensalada

art.	dim. cm.
44357B10	24x24x10
44357B15	24x24x15



SS

Oval fruit basket

Cesto frutta, ovale
Obstschale, oval
Panier à fruits, ovale
Cesta fruta, oval

art.	dim. cm.
42956-19	19x15
42956-24	24,5x18
42956-28	28x21



SS

Round fruit basket

Cesto frutta, tondo
Obstschale, rund
Panier à fruits, rond
Cesta fruta, redonda

art.	Ø cm.
41629-17	17,0
41629-20	20,0
41629-25	25,5



NEW

Wire basket, cotton linen

Cesto in filo, fodera cotone
Drahtkorb, Baumwollfutter
Panier métallique, doublure en coton
Cesta de alambre, forro de algodón

art.	dim. cm.
42878-17	17x12,5x8
42878-25	25x15,5x12



NEW

Wire basket, cotton linen

Cesto in filo, fodera cotone
Drahtkorb, Baumwollfutter
Panier métallique, doublure en coton
Cesta de alambre, forro de algodón

art.	dim. cm.
42877-17	17x12,5x8
42877-25	25x17x12



Bread basket

Cesta baguettes
Brotkorb
Corbeille à pain
Cesta pan

art.	Ø cm.	h. cm.
42948-18	10	7
42948-20	20	7
42948-25	25	7



Bread basket

Cesta baguettes
Brotkorb
Corbeille à pain
Cesta pan

art.	dim. cm.
42948-23	23x15x6,5



Bread basket

Cesta baguettes
Brotkorb
Corbeille à pain
Cesta pan

art.	Ø cm.	h. cm.
42935-19	19	9
42935-26	26	9



Bread basket

Cesta baguettes
Brotkorb
Corbeille à pain
Cesta pan

art.	Ø cm.	h. cm.
42944-23	23	7



Bread basket

Cesta baguettes
Brotkorb
Corbeille à pain
Cesta pan

art.	dim. cm.
42945-27	27x20x10



Bread basket

Cesta baguettes
Brotkorb
Corbeille à pain
Cesta pan

art.	dim. cm.
42945-18	18x13x6,5
42945-23	23x15x6,5



Bread basket

Cesta baguettes
Brotkorb
Corbeille à pain
Cesta pan

art.	Ø cm.	h. cm.	col.
42974C13	13	10	light brown
42974B13	13	10	dark brown
42974M13	13	10	black
42974N13	13	10	black



Round canvas bag

Cesto cotone, rotondo
Brottasche, rund, Baumwolle
Panier à pain rond, coton
Cesta pan redonda, algodón

art.	Ø cm.	h. cm.
42875-17	17	8
42875-20	20	9



Round canvas bag

Cesto cotone, rotondo
Brottasche, rund, Baumwolle
Panier à pain rond, coton
Cesta pan redonda, algodón

art.	Ø cm.	h. cm.
42875B17	17	8
42875B20	20	9



Oval canvas bag

Cesto cotone, ovale
Brottasche, oval, Baumwolle
Panier à pain ovale, coton
Cesta pan , algodón

art.	dim. cm.
42876-20	20x15x7
42876-25	25x18x9

Cotton, machine-washable up to 30° C.
Cotone, lavabile a macchina fino a 30° C.

Cotton, machine-washable up to 30° C.
Cotone, lavabile a macchina fino a 30° C.

Cotton, machine-washable up to 30° C.
Cotone, lavabile a macchina fino a 30° C.



Oval canvas bag

Cesto cotone, ovale
Brottasche, oval, Baumwolle
Panier à pain ovale, coton
Cesta pan , algodón

art.	dim. cm.
42876B20	20x15x7
42876B25	25x18x9

Cotton, machine-washable up to 30° C.
Cotone, lavabile a macchina fino a 30° C.



Round canvas bag

Cesto cotone, rotondo
Brottasche, rund, Baumwolle
Panier à pain, coton
Cesta pan, algodón

art.	Ø cm.	h. cm.	col.
42873-01	20	23,5	●

Cherry stone pillow included. Easy to heat up in microwave for 90 sec. at 500 Watt. – Cuscino in noccioli di ciliegio incluso. Scaldare in microonde per 90 secondi a 500 Watt.



Oval bowl

Ciotola ovale
Schüssel, oval
Bassine ovale
Bol oval

art.	dim. cm.
42931-19	19,5x17



SS

Truffle-slicer

Tagliatartufi
Trüffelschneider
Coupe-truffles
Corta trufa

art.	dim. cm.	des.
48237-00	21x8,5	plain
48237-01	21x8,5	serrated



SS

Truffle-slicer

Tagliatartufi
Trüffelschneider
Coupe-truffles
Corta trufa

art.	dim. cm.	des.
48236-00	21x8,5	plain
48236-01	21x8,5	serrated

Rosewood handle. – Manico in palissandro.



PC

Truffle jar

Confezione Tuberpack
Trüffel-Verpackung
Réceptif à truffes
Envasado para trufa

art.	Ø cm.	h. cm.
48237-99	6	4,5

For transport and storage, prevents weight loss.
Per trasporto e conservazione, previene il calo di peso.



Truffle server

Servitartufi
Trüffel-Service
Service à truffes
Servidor de trufas

art.	dim. cm.
48237-35	30x20x9

Chesnut wood. – Castagno.



SS

Salt/pepper shaker set

Set spargisale/pepe
Salz- und Pfefferstreuer-Set
Set salière et poivrier
Juego 2 piezas sal y pimienta

art.	Ø cm.	h. cm.
42924-02	5	6,5



NEW

AY

Pepper mill

Macina pepe
Pfeffermühle
Moulin à poivre
Molinillo pimienta

art.	h. cm.
17101P12	11,5
17101P16	16,0
17101P20	20,5

Carbon steel mechanism.
Meccanismo acciaio al carbonio.



NEW
AY
SS

Salt mill

Macina sale
Salzmühle
Moulin à sel
Molinillo sal

art.	h. cm.
17101S12	11,5
17101S16	16,0
17101S20	20,5

Ceramic mechanism. – Meccanismo ceramica.



NEW
AY
SS

COPPER - Pepper mill

Macina pepe
Pfeffermühle
Moulin à poivre
Molinillo pimienta

art.	h. cm.	col.
17105P13	13	●

Carbon steel mechanism.
Meccanismo acciaio al carbonio.



NEW
AY
SS

COPPER - Salt mill

Macina sale
Salzmühle
Moulin à sel
Molinillo sal

art.	h. cm.	col.
17105S13	13	●

Ceramic mechanism. – Meccanismo ceramica.



NEW
AY
SS

BLACK GUN - Pepper mill

Macina pepe
Pfeffermühle
Moulin à poivre
Molinillo pimienta

art.	h. cm.	col.
17106P13	13	●

Carbon steel mechanism.
Meccanismo acciaio al carbonio.



NEW
AY
SS

BLACK GUN - Salt mill

Macina sale
Salzmühle
Moulin à sel
Molinillo sal

art.	h. cm.	col.
17106S13	13	●

Ceramic mechanism. – Meccanismo ceramica.



NEW
W

Pepper mill

Macina pepe
Pfeffermühle
Moulin à poivre
Molinillo pimienta

art.	h. cm.
17111P12	11,5
17111P16	16,0
17111P20	20,5

Carbon steel mechanism.
Meccanismo acciaio al carbonio.



NEW
W

Salt mill

Macina sale
Salzmühle
Moulin à sel
Molinillo sal

art.	h. cm.
17111S12	11,5
17111S16	16,0
17111S20	20,5

Ceramic mechanism. – Meccanismo ceramica.



SS

Condiment set 2 pcs

Set 2 pz sale e pepe
Menage, 2-teilig
Ménagère 2 pcs
Servicio de mesa, 2 pz

art.	dim. cm.
42927-02	3x3x5



Salt/pepper shaker, chrome top

Spargisale/pepe cromato
Salz-/Pfefferstreuer, verchromt
Salière/poivrier, chromé
Salero/pimentero, cromado

art.	ml.
42928-00	45



SS

Salt/pepper shaker, set 12 pcs

Spargisale/pepe, set 12 pz
Salz-/Pfefferstreuer, 12 Stk.
Salière/poivrier, set 12 pcs
Salero/pimentero, juego 12 pz

art. Ø cm. h. cm.
42926-12 3 9



SS

Condiment set, 2 pcs

Sale e pepe, 2 pezzi
Menage, 2-teilig
Ménagère, 2 pièces
Servicio de mesa, 2 piezas

art. dim. cm.
42929-01 11,5x5,5x17

Wood base, satin polished handle.
Base legno, manico satinato.



SS

Condiment set, 2 pcs

Servizio oliera, 2 pezzi
Menage, 2-teilig
Ménagère, 2 pièces
Servicio de mesa, 2 piezas

art. dim. cm.
42929-02 16x7,5x24,5

Wood base, satin polished handle.
Base legno, manico satinato.



SS

Condiment set, 4 pcs

Servizio oliera, 4 pezzi
Menage, 4-teilig
Ménagère, 4 pièces
Servicio de mesa, 4 piezas

art. dim. cm.
42929-03 15,5x12x24,5

Wood base, satin polished handle.
Base legno, manico satinato.



NEW

SS

Oil/vinegar sprayer, 2 pcs

Nebulizzatore olio/aceto, 2 pz
Öl-/Essigvernebler, 2 Stück
Nébuliseur huile vinaigre, 2 pièces
Nebulizador aceite/vinagre, 2 pz

art. Ø cm. h. cm. ml.
41635-02 4 18 110



SS

Oil and winegar stand

Porta olio/aceto
Essig u. Öl-Stand
Porte huile et vinaigre
Soporte para aceite y vinagre

art. dim. cm.
66362-02 12,5x6x27



SS

Oil and winegar stand

Porta olio/aceto
Essig u. Öl-Stand
Porte huile et vinaigre
Soporte para aceite y vinagre

art. dim. cm.
41636-25 13x7x30



SS

Condiment set, 4 pcs

Servizio oliera, 4 pezzi
Menage, 4-teilig
Ménagère, 4 pièces
Servicio de mesa, 4 piezas

art. dim. cm.
41638-04 17,5x10,5x23



SS

Condiment set, 2 pcs
Servizio oliera, 2 pezzi
Menage, 2-teilig
Ménagère, 2 pièces
Servicio de mesa, 2 piezas

art.	dim. cm.
41638-02	14,5x8,5x23



SS

Condiment set, 2 pcs
Sale e pepe, 2 pezzi
Menage, 2-teilig
Ménagère, 2 pièces
Servicio de mesa, 2 piezas

art.	dim. cm.
41638-12	10,5x6,5x16



SS

Condiment set, 3 pcs
Set sale, pepe, stecchi
Menage, 3-teilig
Ménagère, 3 pièces
Servicio de mesa, 3 piezas

art.	Ø cm.	h. cm.
41638-13	10,5	16



SS

Cheese jar
Formaggiera
Käsedose
Fromagère
Quesera

art.	Ø cm.	h. cm.
41638-01	10,5	7



SS

Cheese shaker
Spargiformaggio
Käsestreuer
Poudreuse à fromage
Quesera

art.	ml.
42921-00	360



PP

Cutlery/breadstick basket
Portaposate/grissini
Besteck-/Salzstangenkorb
Panier à couverts/grissins
Cesta cubiertos/grissini

art.	Ø cm.	h. cm.
42584-01	12	15



PP

Cutlery dispenser
Portaposate
Besteck-Ablage
Panier à couverts
Cesta portacubiertos

art.	dim. cm.
42584-02	27x10x4,5



PP

Cutlery dispenser
Portaposate
Besteck-Ablage
Panier à couverts
Cesta portacubiertos

art.	dim. cm.
42584-04	53x32,5x10



PP

Cutlery dispenser
Portaposate
Besteck-Ablage
Panier à couverts
Cesta portacubiertos

art.	dim. cm.
42584-05	53x32,5x9



PP

Cutlery dispenser
Portaposate
Besteck-Ablage
Panier à couverts
Cesta portacubiertos

art.	dim. cm.	col.
42584-06	26x18x15	●
42584-07	26x18x15	●





W

Table caddy
Portacondimenti
Tisch-Caddy
Caddy de table
Caddy de mesa

art. Ø cm. h. cm.
41639-17 17,5 8,5



W

Cutlery dispenser
Portaposate
Besteck-Ablage
Panier à couverts
Cesta portacubiertos

art. Ø cm. h. cm.
41639-11 11,5 14



W

Table caddy 4 compartments
Portacondimenti 4 comparti
Tisch-Caddy 4-Fächer
Caddy de table 4 compartiments
Caddy de mesa 4 compartimentos

art. dim. cm. col.
41639-30 17x17x10 ○
41639-31 17x17x10 ●
41639-32 17x17x10 ●

Compartments/Scomparti 7x7 cm.



W

Table caddy 6 compartments
Portacondimenti 6 comparti
Tisch-Caddy 6-Fächer
Caddy de table 6 compartiments
Caddy de mesa 6 compartimentos

art. dim. cm. col.
41639-40 27x17x10 ○
41639-41 27x17x10 ●
41639-42 27x17x10 ●

Compartments/Scomparti 7,5x7,5 cm.



SS

Table-cloth clips, 4 pcs set
Fermatovaglia, set 4 pz
Tischtuch Klammer, 4-Tlg
Pinces à nappe, 4 pièces
Pinzas para mantel, 4 piezas

art.
42953-04

For table/Per tavoli h 3 cm.



SS

Napkin holder
Legatovagliolo
Serviettenring
Porteserviette
Servilletero

art.
42955-00



SS

Dome cover
Cloche
Speiseglocke
Cloche
Cubreplatos

art. Ø cm. h. cm.
41560-28 28 18



SS

Crumb scraper
Raccoglibriciole
Krümelsammler
Ramasse miettes
Recogemigas

art. dim. cm.
42593-00 14



SS

Table crumbler
Raccoglibriciole a tubo
Krümelsammler
Ramasse miettes
Pala recogemigas

art. dim. cm.
41679-23 23,5

TABLE MATS & RUNNERS



Material: 50% polyester - 50% Polyvinyl chloride

Materiale: 50% Poliestere - 50% Cloruro di polivinile



Table mat - Light melange

Tovaglietta - Melange chiaro

art.	dim. cm.	pcs/pz
42950-01	42x33	6



Table mat - Brown

Tovaglietta - Marrone

art.	dim. cm.	pcs/pz
42950-04	42x33	6



Table mat - Crispy

Tovaglietta - Croccante

art.	dim. cm.	pcs/pz
42950-07	42x33	6



Table mat - Sandy

Tovaglietta - Beige

art.	dim. cm.	pcs/pz
42950-02	42x33	6

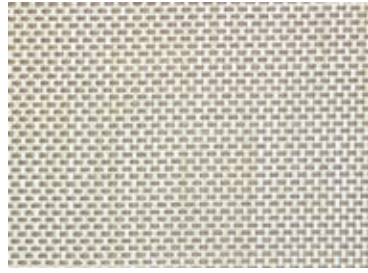

Table mat - Beige-Grey

Tovaglietta - Beige-Grigio

art.	dim. cm.	pcs/pz
42950-05	42x33	6



Table mat - Coral

Tovaglietta - Corallo

art.	dim. cm.	pcs/pz
42950-08	42x33	6

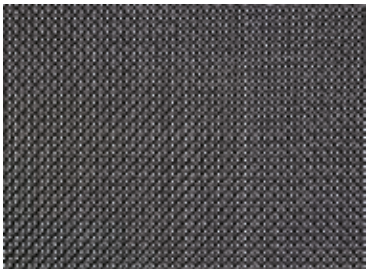

Table mat - Black

Tovaglietta - Nero

art.	dim. cm.	pcs/pz
42950-03	42x33	6



Table mat - Grey

Tovaglietta - Grigio

art.	dim. cm.	pcs/pz
42950-06	42x33	6

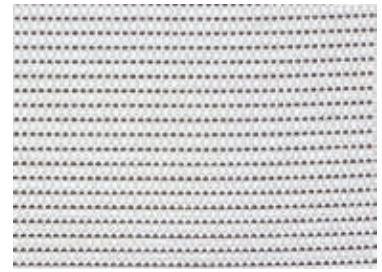

Table mat - White pin-striped

Tovaglietta - Gessato bianco

art.	dim. cm.	pcs/pz
42950-09	42x33	6



RUNNER - Sandy

Beige

art.	dim. cm.
42950-92	42x180

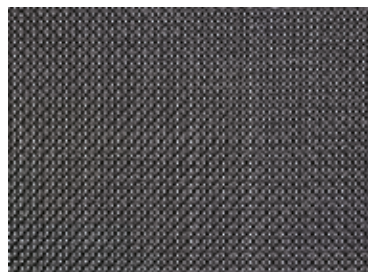

RUNNER - Black

Nero

art.	dim. cm.
42950-93	42x180



RUNNER - Brown

Marrone

art.	dim. cm.
42950-94	42x180



SS

Plate warmer

Rechaud
Speisenwärmer
Réchaud
Calentador de platos

art. Ø cm. h. cm.
41317-20 20 11

Burning time 2 hours with an average flame.
Tempo di combustione 2 ore a fiamma media.



Raclette cheese service, 1/4 shape

Servizio raclette, 1/4 di forma
Raclette-Service
Fondeuse à fromage
Fundidora de queso

art. dim. cm. W
42420-04 28x24x34 600



Raclette cheese service, 1/2 shape

Servizio raclette, 1/2 forma
Raclette-Service
Fondeuse à fromage
Fundidora de queso

art. dim. cm. W
42420-08 26,5x53x40 900



Fondue set, copper

Set fonduta, rame
Fondue-Service, Kupfer
Service à fondue, cuivre
Servicio para fondues, cobre

art. Ø cm. h. cm.
15430-11 16 26



Cheese fondue set

Set fonduta formaggio
Käsefondue-Service
Service à fondue fromage
Servicio para fondues queso

art. Ø cm. h. cm.
41311-00 22 17,5



Bourguignon fondue set

Set fonduta bourguignonne
Bourguignonnefondue-Service
Service à fondue bourguignonne
Servicio para fondues bourguignonne

art. Ø cm. h. cm.
41312-00 20 18



Dipping forks, 6 pcs

Set forchette, 6 pz
6 Stk. Fonduegäbelche
6 curettes à fondue
6 tenedores para fondue

art. l. cm.
15428-06 24



SS

Stand with grill stone

Supporto con pietra ollare
Träger mit Kochstein
Pierre à cuire avec support
Soporte con piedra

art. dim. cm.
41315-02 17x20x12



SS

Stand with grill stone

Supporto con pietra ollare
Träger mit Kochstein
Pierre à cuire avec support
Soporte con piedra

art. dim. cm.
41315-04 44x20x12



SS

Plate warmer

Rechaud
Speisenwärmer
Chauffe-plats
Calentador de platos

art. dim. cm.
41569-33 33x18x6,5

Aluminum plate. – Piastra in alluminio.



W

SS

Plate warmer

Rechaud
Speisenwärmer
Chauffe-plats
Calentador de platos

art. dim. cm.
44251-01 16x16x2,5
44251-03 36x20x2,5



SS

Flambé burner

Fornello crêpes suzettes
Flambier-Rechaud
Réchaud à flamber
Calentador para flambeaar

art. Ø cm. h. cm.
56162-00 18,5 28



SS

Flambé pan

Padella crêpes
Flambierpfanne
Poêle à crêpes
Sartén para crêpes

art.	Ø cm.
56163-27	27
56163-30	30



Mussel pot, enamel cast-iron

Cocotte per molluschi, ferro smaltato
Muscheltopf, emailliertes Stahlblech
Casserole coquillage, émaillée
Cacerola para mejillones, esmaltada

art.	Ø cm.	h cm.	lt.
42414-05	13,5	9,0	0,8
42414-10	18,0	12,0	2,0
42414-15	20,0	13,0	3,0
42414-20	24,0	13,5	4,0



Trivet, cork

Sottopentola, sughero
Korkuntersetzer
Sous-plat, liège
Posavasos de corcho

art.	Ø cm.
42413-24	24



SS

Stand with 4 skewers

Supporto con 4 spiedini
Träger mit 4 Fleischspiesen
Support avec 4 brochettes
Soporte con 4 brochetas

art.	Ø cm.	h cm.
42417-22	22	46



Swing table top waste bin

Portarifiuti da tavola
Tischeimer
Poubelle dé table
Papelera sobremesa

art.	Ø cm.	h cm.
42959-13	12	18



SS

Swing table top waste bin

Portarifiuti da tavola
Tischeimer
Poubelle dé table
Papelera sobremesa

art.	Ø cm.	h cm.
42959-12	12	17



Nut-cracker

Rompinoci
Nussknacker
Casse-noix
Cascanueces

art.
48211-00



SS

Nut-cracker

Schiaccianoci
Nussknacker
Casse-noix
Cascanueces

art.	l. cm.
48210-00	16



SS

Lobster cracker

Pinza aragosta
Hummerzange
Pince à homard
Pinza bogavante

art.	l. cm.
48239-00	20



Lobster cracker, aluminum

Pinza aragosta, alluminio
Hummerzange, Aluminium
Pince à homard, alu
Pinza bogavante, aluminio

art.
48240-00



SS

Sea urchin cutter

Taglia ricci di mare
Seeigel-Messer
Coupe oursin
Cortador de erizo de mar

art.	dim. cm.
48286-68	6x22



SS

Lobster pick

Stiletto aragosta
Hummergabel
Curette à homard
Tenedor bogavante

art.	l. cm.
48238-00	20



SS

Lobster forks
Forchettine per aragosta
Hummergäbelchen
Curettes à homard
Tenedores bogavante

art.	dim. cm.	U. Pack
41594-18	18	5



SS

Picks, set 12 pcs
Spilloncini, set 12 pz
Stocher, 12 Stk.
Pic-bigorneaux, set 12 pcs
Pico-caracoles, juego 12 pz

art.
41594-12



Escargot picks, chromed, set 12 pcs
Forchettine lumache, cromate, set 12 pz
Schneckengabel, verchromed, 12 Stk.
Pic-escargots, chromés, set 12 pcs
Pico-caracoles, cromados, juego 12 pz

art.
41686-12



SS

Escargot dish
Piatto lumache
Schneckenplatte
Plat à escargots
Plato caracoles

art.	comp.
41687-06	6
41687-12	12



SS

Caviar cooler
Coppa caviale
Kaviarkühler
Rafraichisseur à caviar
Copa caviar

art.	Ø cm.	h. cm.
41562-18	18	5



Caviar flatware, mother of pearl
Posate caviale, madreperla
Kaviar-Bestecke, Perlmuttern
Couverts à caviar, nacre
Cuberteria caviar, nácar

art.	dim. cm.	des.
41518-00	11,5	spoon
41518-01	10,5	knife
41518-02	11,5	fork



SS

Oyster plate
Piatto frutti di mare
Austernplatte
Plat à huîtres
Fuente de mariscos

art.	Ø cm.
41591-90	45-36



SS

Seafood display rack, chromed
Supporto acciaio cromato
Unterteil für Austernplatte, verchromt
Support en fil chromé
Soporte cromado para fuente mariscos

art.	Ø cm.	h. cm.
41593-20	19-25	20



SS

Fruit stand
Alzata Royale
Obstständer
Etagère Royale
Expositor de frutas

art.	Ø cm.	h. cm.
41820-03	24-33-42	50



Oyster tray, aluminum

Vassoio frutti di mare, alluminio
Austernplatte, Aluminum
Plat à huîtres, alu
Fuente de mariscos, aluminio

art.	Ø cm.	h. cm.
41591-32	32	6
41591-36	36	6
41591-40	40	6
41591-45	45	6



Oyster plate

Piatto frutti di mare
Austernplatte
Plat à huîtres
Fuente de mariscos

art.	Ø cm.	h. cm.
41592-36	36	4,0
41592-45	45	5,5

SS



Table bag holder

Gancio appendi borsa
Handtaschentischhänger
Crochet de table
Colgador de bolso

art.
41559-04

SS



Wine bucket table clip, chrome

Supporto secchio da tavola, cromato
Flaschenkühler-Tischbefestigung, verchromt
Porte-seau à champagne, chromé
Soporte de mesa cubo champán, cromado

art.
41558-00

Per/For: 41501-20, 41502-20.



Wine bucket

Secchiello vino
Sektkühler
Seau à champagne
Cubo champán

art.	Ø cm.	h. cm.
41502-20	20	20

SS



Champagne bucket, aluminum

Secchiello champagne, alluminio
Sektkühler, Aluminum
Seau à champagne, alu
Cubo champán, aluminio

art.	Ø cm.	h. cm.
41501-20	20	21



SS

Wine cooler

Secchiello vino
Weinkühler
Seau à vin
Cubo vino

art.	Ø cm.	h. cm.	bot.
56120-18	18,5	16	1/2
56120-22	20,0	21	1
56120-24	24,0	22	2



SS

White wine cooler

Secchio vino bianco
Weissweinkühler
Seau à vin blanc
Cubo vino blanco

art.	Ø cm.	h. cm.
56118-20	20	25



SS

Wine cooler stand

Colonna portasecchiello
Ständer für Weinkühler
Support seau à champagne
Soporte para cubo

art.	Ø cm.	h. cm.
41505-20	20	70,5



SS

Wine cooler stand

Colonna portasecchiello
Ständer für Weinkühler
Support seau à champagne
Soporte para cubo

art.	Ø cm.	h. cm.
41505-17	17,0	64,5
41505-19	19,5	64,0



SS

Bottle cooler

Glacette termica
Flaschenkühler
Rafraîchisseur à bouteille
Enfriador isotérmico

art.	Ø cm.	h. cm.
41508C12	12/10	20



Bottle cooler, beton

Glacette, cemento
Flaschenkühler, Beton
Rafraîchisseur à bouteille, béton
Enfriador, cemento

art.	Ø cm.	h. cm.
41504-19	12/10	19



SS

Bottle cooler

Glacette termica
Flaschenkühler
Rafraîchisseur à bouteille
Enfriador isotérmico

art.	Ø cm.	h. cm.
41504-09	9,5	22,5



SS

Bottle cooler

Glacette termica
Flaschenkühler
Rafraîchisseur à bouteille
Enfriador isotérmico

art.	Ø cm.	h. cm.
41504-10	10	21



SS

Bottle cooler

Glacette termica
Flaschenkühler
Rafraîchisseur à bouteille
Enfriador isotérmico

art.	Ø cm.	h. cm.
41508-10	10	30



PP

Bottle cooler

Glacette termica
Flaschenkühler
Rafraîchisseur à bouteille
Enfriador isotérmico

art.	Ø cm.	h. cm.
41504-12	12,5/10	22



PP

Bottle cooler

Glacette termica
Flaschenkühler
Rafraîchisseur à bouteille
Enfriador isotérmico

art.	Ø cm.	h. cm.
41504-11	10	22



SAN
SS

Bottle cooler

Glacette termica
Flaschenkühler
Rafraîchisseur à bouteille
Enfriador isotérmico

art.	Ø cm.	h. cm.
41507-01	11,5/9,5	23



AG

Wine basket

Cestino vino
Weinkorb
Panier à vin
Cesta para botella

art.
31509-01



SS

Wine holder

Versavino a molla
Weingestell
Porte-Bouteille
Soporte para botella

art. Ø cm.
41510-08 8



SS

Wine holder

Versavino reversibile
Weingestell
Porte-Bouteille
Soporte para botella

art. l. cm.
56123-00 17



Wine collar, chromed

Collare salvagoccia, cromato
Tropfenfänger, verchromt
Collier anti-gouttes, chromé
Anillo anti-goteo, cromado

art.
41511-00



SS

Wine taster

Tastevin
Weinprobenschale
Tastevin
Catador del vino

art. Ø cm.
41499-08 8,5



Cognac warmer, palladium

Scaldacognac, palladio
Cognacwärmer, Palladium
Réchaud à cognac, palladium
Calentador brandy, paladio

art. h. cm.
41678-14 14,5



SS

Pourer

Versatore
Ausgießer
Verseur
Vertedor

art.
41511-20



Champagne tong, chromed

Pinza champagne, cromata
Champagner-Zange, verchromed
Pince à champagne, chromée
Pinza Champaña, cromada

art.
41511-30



Wine aerator

Ossigenatore per vino
Dekanter
Carafe à décanter
Decantador

art. Ø cm. h. cm.
41511-25 8 19

Decants wine in seconds.
Ideale per ossigenare all'istante il vino.



Champagne saber

Sciabola per Sommelier
Champagnersäbel
Sabra à champagne
Sable para Champán

art. l. cm.
41496-40 40



Flower vase, nickel plated

Vaso fiori, nichelato
Blumenvase, vernickelt
Vase à fleurs, nickelé
Florero, zinc-níquel

art. Ø cm. h. cm.
42942-16 4 16,5



SS

Flower vase

Vaso fiori
Blumenvase
Vase à fleurs
Florero

art. h. cm.
41628-15 15



AG

Candlestick
Candeliere
Kerzenleuchter
Chandelier
Candelabro una vela

art.	Ø cm.	h. cm.
32931-02	10	20,5



AG

Candelabra 3 lights
Candelabro 3 luci
Kerzenleuchter, 3-flammig
Chandelier, 3 branches
Candelabro, 3 brazos

art.	Ø cm.	h. cm.
32931-03	10	22,5



AG

Candelabra 5 lights
Candelabro 5 luci
Kerzenleuchter, 5-flammig
Chandelier, 5 branches
Candelabro, 5 brazos

art.	Ø cm.	h. cm.
32931-05	10	24



AG

Candlestick
Candeliere
Kerzenleuchter
Chandelier
Candelabro una vela

art.	Ø cm.	h. cm.
32935-10	10	10
32935-22	10	22



AG

Candelabra 5 lights
Candelabro 5 luci
Kerzenleuchter, 5-flammig
Chandelier, 5 branches
Candelabro, 5 brazos

art.	Ø cm.	h. cm.
42443-06	17	56
42443-08	24	78
42443-10	24	98



AG

Candelabra 3 lights
Candelabro 3 luci
Kerzenleuchter, 3-flammig
Chandelier, 3 branches
Candelabro, 3 brazos

art.	Ø cm.	h. cm.
32935-03	11	25



AG

Candelabra 5 lights
Candelabro 5 luci
Kerzenleuchter, 5-flammig
Chandelier, 5 branches
Candelabro, 5 brazos

art.	Ø cm.	h. cm.
32935-05	11	25



AG

Candelabra 3 lights
Candelabro 3 luci
Kerzenleuchter, 3-flammig
Chandelier, 3 branches
Candelabro, 3 brazos

art.	Ø cm.	h. cm.
32936-03	13	39



AG

Candelabra 5 lights
Candelabro 5 luci
Kerzenleuchter, 5-flammig
Chandelier, 5 branches
Candelabro, 5 brazos

art.	Ø cm.	h. cm.
32936-05	13	39



SS

Candleholder satin finish, set 2 pcs

Portacandela satinato, set 2 pz
Windlicht, mattiert, 2er Set
Bougeoir satin mat, set 2 pcs
Portavela satinado, set 2 pz

art.	Ø cm.	h. cm.
42939-15	5	15



Candleholder, chromed

Portacandela, cromato
Windlicht, verchromt
Bougeoir, chromé
Portavela, cromado

art.	Ø cm.	h. cm.
42941-22	11	22



NEW



Set 4 tea light candles

Set 4 candele tea light
Kunststeilichter, 4er Set
Set 4 bougies chauffeplat
Set 4 velas de tè

art.	Ø cm.	h. cm.
42446-04	3,65	3,53

Resin. Timer function 5 hours ON/19 OFF. Powered by one T2450 alkaline battery (not incl.). Working time >50 hours. Flameless moving wick. – Resina. Funzione timer 5 ore ON/19 OFF. 1 batteria alcalina R2450 (non incl.). Durata > 50 ore. Stoppino mobile senza fiamma.



NEW



Set 3 candele

Set 3 candles
Kunstkerzen, 3er Set
Set 3 bougies
Set 3 velas

art.	Ø cm.	h. cm.
42445-03	9	12,5
	9	18,0
	9	23,0

Resin. Timer function 5 hours ON/19 OFF. Powered by 2D alkaline batteries (not incl.). Working time >800 hours. Flameless moving wick. – Resina. Funzione timer 5 ore ON/19 OFF. 2 batterie alcaline D (non include). Durata > 800 ore. Stoppino mobile senza fiamma.



SS

Menu stand

Porta menù
Speisekartenhalter
Porte-menu
Portamenús

art.	dim. cm.
42951-08	8x7x2



SS

Table number stand, 4 pcs set

Supporto numero tavola, set 4 pz
Tischnummerständer, Satz 4 Stk
Support numéro de table, set 4 pcs
Soporte número de mesa, set 4 pz

art.	Ø cm.	h. cm.
42954-04	4	10



SS

Table number stand

Supporto numero tavola
Tischnummerständer
Support numéro de table
Soporte número de mesa

art.	Ø cm.	h. cm.
42954-18	7,5	18,5
42954-29	7,5	29,0
42954-46	7,5	46,0



SS

Card holder

Supporto targhetta
Kartenhalter
Porte-cartes
Portatarjetas

art.	dim. cm.
42952-05	6x5x3



SS

Table sign, 2 pcs set

Targhetta tavola, set 2 pz
Tischaufsteller, Satz 2 Stk
Plaque de table, set 2 pcs
Placa de mesa, set 2 pz

art. dim. cm.
42951-57 5,5x5x3,5



SS

Table sign, 2 pcs set

Targhetta tavola, set 2 pz
Tischaufsteller, Satz 2 Stk
Plaque de table, set 2 pcs
Placa de mesa, set 2 pz

art. dim. cm.
42951-59 5,5x5x3,5



SS

Reception bell

Campanella reception
Receptionsschell
Sonette de réception
Timbre recepción

art. Ø cm. h. cm.
41390-00 8,5 6



Table cigar cutter

Tagliasigari da tavola
Zigarrenscheider
Coupe-cigares
Guillotina para puros

art. dim. cm.
48244-07 9x4

Double blad. Assorted models.
Doppia lama. Modelli assortiti.



SS

Table cigar cutter

Tagliasigari da tavola
Zigarrenscheider
Coupe-cigares
Guillotina para puros

art. dim. cm.
48244-04 4x4



SS

Table cigar cutter

Tagliasigari da tavola
Zigarrenscheider
Coupe-cigares
Guillotina para puros

art. dim. cm.
48242-09 9x4



SS

Cigar scissors

Forbice sigari
Zigarrenscherer
Ciseaux à cigares
Cortador para puros

art. dim. cm.
48245-10 10x5



PMMA

W

Cigar humidor

Vetrina sigari
Zigarren-Vitrine
Vitrine à cigares
Vitrina para puros

art. dim. cm.
48245-75 30x24x13

Holds about 50-75 cigars in relation to the cigar ring, equipped with built-in hygrometer. Cedar interior. – Per c.ca 50-75 sigari in relazione al ring del sigaro, dotato di igrometro incorporato. Interno in cedro.



SS

Cigar ashtray

Portasigaro con piattino
Aschenbecher mit Zigarrenhalter
Cendrier à cigares
Cenicero para puros

art. Ø cm.
48241-14 14,5



SS

Ashtray

Posacenere
Aschenbecher
Cendrier
Cenicero

art. Ø cm.
48247-10 10



SS

Ashtray

Posacenere
Aschenbecher
Cendrier
Cenicero

art. Ø cm. h. cm.
48250-10 10 4,5
48250-12 12 4,5



PR

Ashtray

Posacenere
Aschenbecher
Cendrier
Cenicero

art. Ø cm.
44366-10 10



Ashtray, chrome plated
Posacenere, cromato
Aschenbecher, Metall hartverchromt
Cendrier, chromé
Cenicero, cromado

art.	Ø cm.	h. cm.
48249-13	13	10,5



Ashtray, 3 pcs set
Posacenere, set 3 pz
Aschenbecher, 3 Stk
Cendrier, set 3 pièces
Cenicero, 3 pz

art.	Ø cm.	h. cm.	col.
48251-03	8	3	●



Ashtray
Posacenere
Aschenbecher
Cendrier
Cenicero

art.	Ø cm.	h. cm.	col.
48253B09	9,5	4,5	●



Ashtray
Posacenere
Aschenbecher
Cendrier
Cenicero

art.	Ø cm.	h. cm.	col.
48253-09	9,5	4,5	○



Ashtray
Posacenere
Aschenbecher
Cendrier
Cenicero

art.	Ø cm.	h. cm.	col.
48252-10	10	4,0	○
48252-12	12	4,5	○



Ashtray
Posacenere
Aschenbecher
Cendrier
Cenicero

art.	Ø cm.	h. cm.	col.
48252B10	10	4,0	●
48252B12	12	4,5	●



PEUGEOT MILLS MACINE



TABLE TOP
TAVOLA



MECHANISMS
MECCANISMI

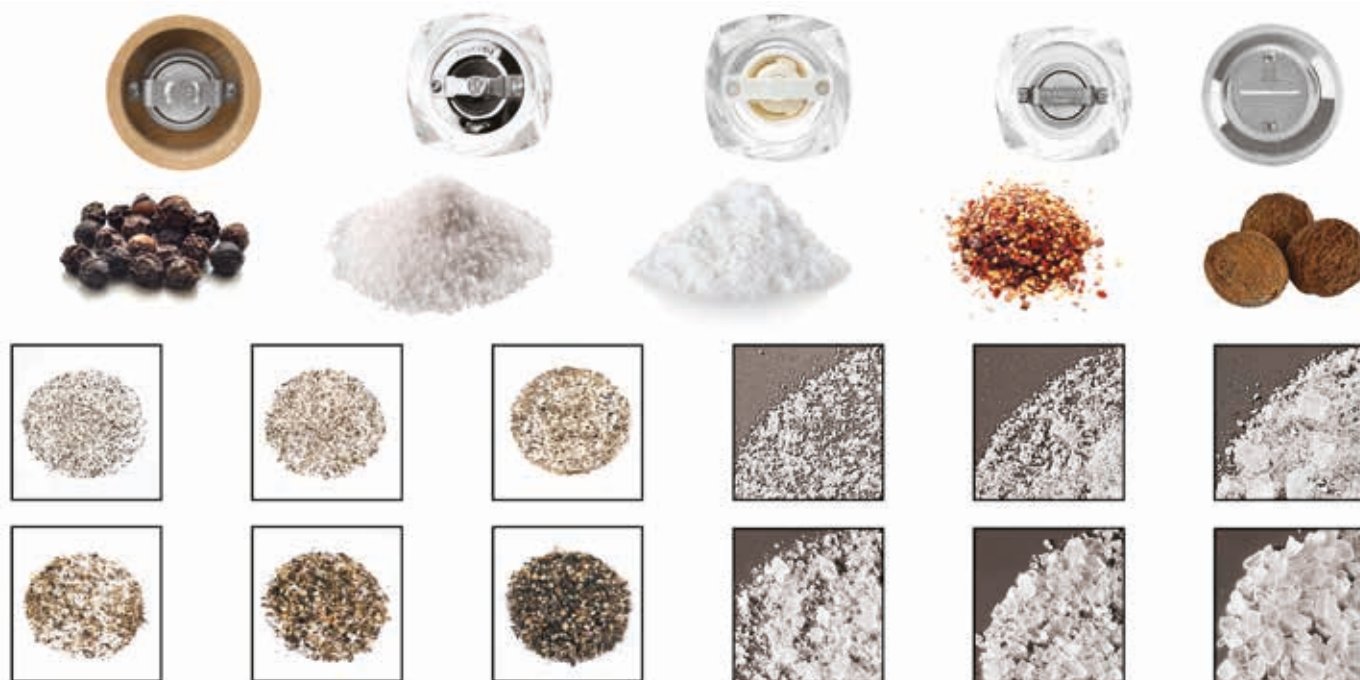

PEPPER

The pepper mechanism is equipped with a helix-shaped double row of teeth that guide and hold the peppercorns for a perfect grind. It has a patented treatment that protects the steel from corrosion while maintaining its sharpness and wear resistance. To get the best out of your Peugeot pepper grinding mechanism, we recommend to use peppercorns with a diameter of 5 mm (1/4") or less. Black, white and dry green peppercorns can be ground in Peugeot pepper mills. The pink berries can be ground only if in a blend (max 15% pink) with one of these other peppercorns. Dried coriander seeds are also suitable for the pepper mechanism.

SALT

The Peugeot salt mechanism is designed to grind cooking salt. It is made of stainless steel and is not sensitive to salt corrosion. To get the best out of your Peugeot salt grinding mechanism, you should use: salt with a diameter of 4 mm (3/16") or dry coarse salt: dry sea salt or rock salt. Do not use for pepper or any other spice. Do not use with wet sea salt or flowers of salt, Guérande, Ré, Maldon, pink salt, etc.

WET SEA SALT

A specially designed mill for wet sea salt. The natural consistency and moisture content do not allow the use of an ordinary salt mill. Innovative patented system for a high-performance grind without blockage even with very humid or compressed salt. This specific mechanism is composed of 3 stops ensuring both mechanism resistance and constant output, and an anti-clogging spiral which shuffles the salt in the reservoir. Peugeot ceramic exclusive mechanism, Made in France.

CHILI PEPPER

The chili pepper mechanism is a Peugeot exclusive product. This patented model has a pre-cutting system and a mechanism that grinds dry chili pepper. Like the pepper grinder it has a patented treatment that protects the steel from corrosion while maintaining its sharpness and wear resistance.

NUTMEG

The Peugeot nutmeg mill is equipped with a double stainless steel blade/grater and a strong claw which enables the nutmeg to be very finely ground.

ADJUSTABLE GRINDING SYSTEM

For electric or manual mills.

Patented system that enables precise grind adjustment settings. 6 pre-defined levels of grind for pepper and 6 for salt. Easy: just rotate the ring at the base of the mill and select one of the positions, each corresponding to a specific grain.

CLASSIC ADJUSTABLE SYSTEM

Thumbwheel grind adjustment on electric grinders is found below the grinding mechanism. Grind adjustment nut on manual mills, turn the nut. Clockwise to obtain a finer grind, counter-clockwise to obtain a coarser grind.

PEPE

Il meccanismo è dotato di una doppia fila di denti elicoidali che catturano il grano, lo spingono verso il basso e lo bloccano per macinarlo perfettamente. Subisce un trattamento brevettato che protegge l'acciaio dalla corrosione pur mantenendo la sua affilatura e resistenza all'usura. Per ottenere i migliori risultati, si consiglia di utilizzare solo pepe in grani secchi da 5 mm o meno di diametro. Si possono macinare pepe verde, nero, e bianco. Le bacche rosse possono essere macinate solo se miscelate (max 15%) con altri grani di pepe. Semi di coriandolo secchi sono anch'essi adatti per il meccanismo macina pepe.

SALE

Il meccanismo per il sale Peugeot è disegnato per macinare sale marino grosso. Realizzato in acciaio inossidabile resiste alla corrosione provocata dal sale asciutto. Non usare con pepe ed altre spezie, con sale di mare umido o con fiore di sale (Guérande, Ré, Malton, sel rose...). Per ottimizzare la resa del meccanismo si consiglia di utilizzare sale con un diametro di 4 mm.

SALE UMIDO

Un innovativo sistema brevettato appositamente progettato per sale marino bagnato la cui consistenza naturale ed il contenuto di umidità non permettono l'uso di un comune macinasale. Il meccanismo assicura un'ottima macina, un'uscita costante, e una spirale che mescola il sale affinché non si attacchi. Esclusivo meccanismo di ceramica, Made in France.

PEPERONCINO

Questo meccanismo è un prodotto esclusivo Peugeot. Il modello brevettato ha un sistema di pre-taglio e un meccanismo che permettono di macinare il peperoncino essiccato. Come il macinapepe, il meccanismo subisce un trattamento brevettato che protegge l'acciaio dalla corrosione pur mantenendo la sua affilatura e resistenza all'usura.

NOCE MOSCATA

La macina è dotata di una doppia lama per grattugiare in acciaio inox e di un robusto dischetto uncinato che permette di grattugiare l'intera noce molto finemente.

IMPOSTAZIONE DELLA MACINA

Per macine manuali ed elettriche.

Sistema brevettato che permette una regolazione predefinita della macinatura. 6 Livelli per il pepe e 6 Livelli per il sale. Facile: basta ruotare l'anello alla base della macina e selezionare una delle posizioni, ognuna corrisponde ad una determinata grana.

REGOLAZIONE CLASSICA

Negli apparecchi elettrici la rotella di regolazione si trova sotto il meccanismo di macinatura. Negli apparecchi manuali la regolazione si effettua ruotando il dado/pomolino. Ruotare in senso orario per ottenere una macinatura più fine, in senso antiorario per ottenere una macinatura più grossa.

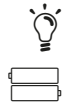

ALASKA Duo, electric pepper/salt mill

Duo, macinapepe/sale, elettrici
Duo, Pfeffer-/Salzmühle
Duo, moulin à poivre/sel
Duo, molinillo pimienta/sal

art. h. cm.
42660-02 17

PC/Acrylic. – PC/Acrilico.

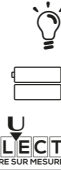

SELECT
MOÛTURE SUR MESURE

ELIS SENSE Pepper/salt mill

Macina pepe/sale
Pfeffer-/Salzmühle
Moulin à poivre/sel
Molinillo pimienta/sal

art.-P art.-S h. cm.
42785S20 42786S20 20

Stainless steel. Incl. small dish and spice vial with funnel. – Inox. Incl. vassoietto e fiala dosatrice con imbuto.

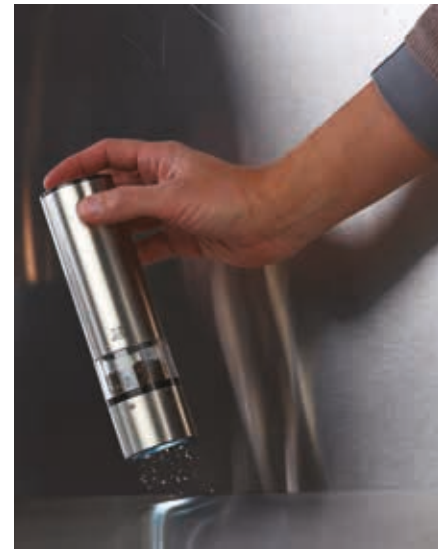

ZEPHIR Pepper/salt mill

Macina pepe/sale
Pfeffer-/Salzmühle
Moulin à poivre/sel
Molinillo pimienta/sal

art.-P art.-S h. cm.
42692B14 42693B14 14

ABS stainless steel look. Soft touch.
ABS imitazione inox. Soft touch.



ZELI Pepper/salt mill

Macina pepe/sale
Pfeffer-/Salzmühle
Moulin à poivre/sel
Molinillo pimienta/sal

art.-P art.-S h. cm.
42801P14 42801S14 14

ABS stainless steel look. – ABS imitazione inox.

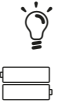

ONYX Pepper/salt mill

Macina pepe/sale
Pfeffer-/Salzmühle
Moulin à poivre/sel
Molinillo pimienta/sal

art.-P art.-S h. cm.
42800P20 42800S20 20

Soft touch.



BISTRO Pepper/salt mill

Macina pepe/sale
Pfeffer-/Salzmühle
Moulin à poivre/sel
Molinillo pimienta/sal

art.-P art.-S h. cm.
42701-10 42703-10 10

Beech wood, natural. – Faggio naturale.



BISTRO Pepper/salt mill

Macina pepe/sale
Pfeffer-/Salzmühle
Moulin à poivre/sel
Molinillo pimienta/sal

art.-P art.-S h. cm.
42702-10 42704-10 10

Beech wood, chocolate. – Faggio cioccolato.



BISTRO Pepper/salt mill

Macina pepe/sale
Pfeffer-/Salzmühle
Moulin à poivre/sel
Molinillo pimienta/sal

art.-P art.-S h. cm.
42702P10 42704S10 10

Beech wood, black matt. – Faggio nero opaco.



BISTRO Pepper/salt mill

Macina pepe/sale
Pfeffer-/Salzmühle
Moulin à poivre/sel
Molinillo pimienta/sal

art.-P art.-S h. cm.
42701P10 42703S10 10

Beech wood, white matt. – Faggio bianco opaco.



BISTRO ANTIQUE Pepper/salt mill

Macina pepe/sale
Pfeffer-/Salzmühle
Moulin à poivre/sel
Molinillo pimienta/sal

art.-P art.-S h. cm.
42705P10 42705S10 10

Beech wood antique. – Faggio anticato.



BISTRO CHEF Pepper/salt mill

Macina pepe/sale
Pfeffer-/Salzmühle
Moulin à poivre/sel
Molinillo pimienta/sal

art.-P art.-S h. cm.
42624P10 42624S10 10



W

PARIS ANTIQUE Pepper/salt mill

Macina pepe/sale
Pfeffer-/Salzmühle
Moulin à poivre/sel
Molinillo pimienta/sal

art.-P	art.-S	h. cm.
42749P18	42749S18	18
42749P22	42749S22	22
42749P30		30

Beech wood antique. – Faggio anticato.



W

PARIS Pepper/salt mill

Macina pepe/sale
Pfeffer-/Salzmühle
Moulin à poivre/sel
Molinillo pimienta/sal

art.-P	art.-S	h. cm.
42746P12		12
42746P18	42746S18	18
42746P22	42746S22	22
42746P30	42746S30	30
42746P40		40
42746P50		50
42746P80		80

Beech wood, chocolate. – Faggio cioccolato.



W

PARIS Pepper/salt mill

Macina pepe/sale
Pfeffer-/Salzmühle
Moulin à poivre/sel
Molinillo pimienta/sal

art.-P	art.-S	h. cm.
42747P12	42747S12	12
42747P18	42747S18	18

Beech wood, black lacquered.
Faggio laccato nero.



U
SELECT
MOUTURE SUR MESURE

PARIS Pepper/salt mill

Macina pepe/sale
Pfeffer-/Salzmühle
Moulin à poivre/sel
Molinillo pimienta/sal

art.-P	art.-S	h. cm.
42665P12	42665S12	12
42665P18	42665S18	18
42665P22	42665S22	22
42665P27	42665S27	27
42665P30	42665S30	30
42665P40	42665S40	40

Beech wood, natural. – Faggio naturale.



U
SELECT
MOUTURE SUR MESURE

PARIS Pepper/salt mill

Macina pepe/sale
Pfeffer-/Salzmühle
Moulin à poivre/sel
Molinillo pimienta/sal

art.-P	art.-S	h. cm.
42666P12	42666S12	12
42666P18	42666S18	18
42666P22	42666S22	22
42666P27	42666S27	27
42666P30	42666S30	30
42666P40	42666S40	40

Beech wood, chocolate. – Faggio cioccolato.



U
SELECT
MOUTURE SUR MESURE

PARIS Pepper/salt mill

Macina pepe/sale
Pfeffer-/Salzmühle
Moulin à poivre/sel
Molinillo pimienta/sal

art.-P	art.-S	h. cm.
42667P12	42667S12	12
42667P18	42667S18	18
42667P22	42667S22	22
42667P30	42667S30	30

Beech wood, black lacquered. – Faggio laccato nero.



PARIS Pepper/salt mill

Macina pepe/sale
Pfeffer-/Salzmühle
Moulin à poivre/sel
Molinillo pimienta/sal

art.-P	art.-S	h. cm.
42664P12	42664S12	12
42664P18	42664S18	18
42664P22	42664S22	22
42664P30	42664S30	30
42664P40		40

Beech wood, white lacquered.
Faggio laccato bianco.



PARIS Pepper/salt mill

Macina pepe/sale
Pfeffer-/Salzmühle
Moulin à poivre/sel
Molinillo pimienta/sal

art.-P	art.-S	h. cm.
42668P12	42668S12	12
42668P18	42668S18	18
42668P22	42668S22	22
42668P30	42668S30	30
42668P40		40

Beech wood, red lacquered.
Faggio laccato rosso.



PARIS CHEF Pepper/salt mill

Macina pepe/sale
Pfeffer-/Salzmühle
Moulin à poivre/sel
Molinillo pimienta/sal

art.-P	art.-S	h. cm.
42674P18	42674S18	18
42674P22	42674S22	22
42674P30	42674S30	30

Stainless steel. – Inox.



CHATEAUNEUF Pepper/salt mill

Macina pepe/sale
Pfeffer-/Salzmühle
Moulin à poivre/sel
Molinillo pimienta/sal

art.-P	art.-S	h. cm.
42781-23	42783-23	23
42781-30	42783-30	30

Stainless steel/beech wood, black matt.
Inox/faggio nero opaco.



CHÂTEL Pepper/salt mill

Macina pepe/sale
Pfeffer-/Salzmühle
Moulin à poivre/sel
Molinillo pimienta/sal

art.-P	art.-S	h. cm.	col.
42707P21	42707S21	21	●
42709P21	42709S21	21	●



HOSTELLERIE Pepper mill

Macina pepe
Pfeffermühle
Moulin à poivre
Molinillo pimienta

art.	h. cm.	col.
42741-22	22	●
42742-22	22	●



BRASSERIE Duo, pepper/salt mill

Duo, macina pepe/sale
Duo, Pfeffer-/Salzmühle
Duo, moulin à poivre/sel
Duo, molinillo pimienta/sal

art.	h. cm.
42710-11	11

ABS chromed/acrylic. – ABS cromato/acrilico.



ROYAN Pepper/salt mill

Macina pepe/sale
Pfeffer-/Salzmühle
Moulin à poivre/sel
Molinillo pimienta/sal

art.-P	art.-S	h. cm.
42677P14	42677S14	14

Beech wood. – Faggio.



MADRAS Pepper/salt mill

Macina pepe/sale
Pfeffer-/Salzmühle
Moulin à poivre/sel
Molinillo pimienta/sal

art.-P	art.-S	h. cm.
42705P16	42705S16	16
42705P21	42705S21	21

Beech wood chocolate/stainless steel.
Faggio cioccolato/inox.



MADRAS Nutmeg mill

Macina noce moscata
Muskatmühle
Moulin à mouscade
Molinillo nuez moscada

art.	h. cm.
42705M15	15

Beech wood chocolate. Magnetic stopper.
Compartment for 3 nutmegs. – Faggio cioccolato.
Tappo magnetico. Scompartimento per 3 noci.



FIDJI Pepper/salt mill

Macina pepe/sale
Pfeffer-/Salzmühle
Moulin à poivre/sel
Molinillo pimienta/sal

art.-P	art.-S	h. cm.
42767P12	42767S12	12
42767P15	42767S15	15
42767P20	42767S20	20

Beech wood, black matt. – Faggio nero opaco.



FIDJI OLIVE Pepper/salt mill

Macina pepe/sale
Pfeffer-/Salzmühle
Moulin à poivre/sel
Molinillo pimienta/sal

art.-P	art.-S	h. cm.
42676P15	42676S15	15
42676P20	42676S20	20

Stainless steel/olive wood. – Inox/ulivo.



DAMAN Pepper/salt mill

Macina pepe/sale
Pfeffer-/Salzmühle
Moulin à poivre/sel
Molinillo pimienta/sal

art.-P	art.-S	h. cm.
42764P16	42764S16	16
42764P21	42764S21	21



DAMAN Nutmeg mill

Macina noce moscata
Muskatmühle
Moulin à mouscade
Molinillo nuez moscada

art.	h. cm.
42764M15	15

Magnetic stopper. Compartment for 3 nutmegs.
Tappo magnetico. Scompartimento per 3 noci.



BALI Pepper mill

Macina pepe
Pfeffermühle
Moulin à poivre
Molinillo pimienta

art.	h. cm.	col.
42661-02	8	●
42661-03	8	●



BALI Salt mill

Macina sale
Salzmühle
Moulin à sel
Molinillo sal

art.	h. cm.	col.
42661-06	8	○



AY

CHAUMONT Pepper/salt mill

Macina pepe/sale
Pfeffer-/Salzmühle
Moulin à poivre/sel
Molinillo pimienta/sal

art.-P	art.-S	h. cm.
42798P11	42798S11	11
42798P16	42798S16	16



AY

VITTEL Pepper/salt mill

Macina pepe/sale
Pfeffer-/Salzmühle
Moulin à poivre/sel
Molinillo pimienta/sal

art.-P	art.-S	h. cm.
42796P16	42796S16	16
42796P23	42796S23	23
42796P30	42796S30	30



AY

W

OLERON Wet sea salt mill

Macina per sale umido
Mühle für Feuchtes Meersalz
Moulin à sel humide
Molinillo sal húmeda

art.	h. cm.
42670N14	14

Beech wood. – Faggio.



AY

W

OLERON Wet sea salt mill

Macina per sale umido
Mühle für Feuchtes Meersalz
Moulin à sel humide
Molinillo sal húmeda

art.	h. cm.
42670B14	14

Beech wood. – Faggio.



AY

MOLENE Wet sea salt mill

Macina per sale umido
Mühle für Feuchtes Meersalz
Moulin à sel humide
Molinillo sal húmeda

art.	h. cm.
42670W14	14



AY

NANCY Wet sea salt mill

Macina per sale umido
Mühle für Feuchtes Meersalz
Moulin à sel humide
Molinillo sal húmeda

art.	h. cm.
42728S18	18



AY

NANCY Pepper/salt mill

Macina pepe/sale
Pfeffer-/Salzmühle
Moulin à poivre/sel
Molinillo pimienta/sal

art.-P	art.-S	h. cm.
42727-09	42728-09	9
42727-12	42728-12	12
42727-18	42728-18	18
42727-22	42728-22	22
42727-30	42728-30	30
42727-38	42728-38	38



NEW

SS

AY

OSLO Pepper/salt mill

Macina pepe/sale
Pfeffer-/Salzmühle
Moulin à poivre/sel
Molinillo pimienta/sal

art.-P	art.-S	h. cm.
42678P14	42678S14	14



NEW

SS

AY

OSLO Wet sea salt mill

Macina per sale umido
Mühle für Feuchtes Meersalz
Moulin à sel humide
Molinillo sal húmeda

art.	h. cm.
42678W14	14



SS
AY

OUESSANT Pepper/salt mill

Macina pepe/sale
Pfeffer-/Salzmühle
Moulin à poivre/sel
Molinillo pimienta/sal

art.-P art.-S h. cm.
42669P14 42669S14 14



SS
AY

OUESSANT Herbs/chili mill

Macina erbe/peperoncino
Kräuter-/Paprikamühle
Moulin à herbes/piment
Molinillo hierbas/chile

art. h. cm.
42669C14 14



AY
W

OLERON Pepper/salt mill

Macina pepe/sale
Pfeffer-/Salzmühle
Moulin à poivre/sel
Molinillo pimienta/sal

art.-P art.-S h. cm.
42663P14 42663S14 14

Beech wood. – Faggio.



AY
W

OLERON Herbs/chili mill

Macina erbe/peperoncino
Kräuter-/Paprikamühle
Moulin à herbes/piment
Molinillo hierbas/chile

art. h. cm.
42663C14 14

Beech wood. – Faggio.



AY
W

OLERON Pepper/salt mill

Macina pepe/sale
Pfeffer-/Salzmühle
Moulin à poivre/sel
Molinillo pimienta/sal

art.-P art.-S h. cm.
42662P14 42662S14 14

Beech wood. – Faggio.



AY
W

OLERON Herbs/chili mill

Macina erbe/peperoncino
Kräuter-/Paprikamühle
Moulin à herbes/piment
Molinillo hierbas/chile

art. h. cm.
42662C14 14

Beech wood. – Faggio.



NEW
W
SS

ISEN Flax seeds mill

Macina semi lino/sesamo
Leinsamen-Mühle
Moulin à graines de lin
Molino de semillas de lino

art. h. cm.
42680-13 13

Supplied with spoon of 5 g.
Fornito con un cucchiaino da 5 g.



ABS
AY

TIDORE Nutmeg mill

Macina noce moscata
Muskatmühle
Moulin à mouscade
Molinillo nuez moscada

art. h. cm.
42720-00 11

Compartment for 7/8 nutmegs.
Serbatoio per 7/8 noci.



AY

TERNATE Nutmeg mill

Macina noce moscata
Muskatmühle
Moulin à mouscade
Molinillo nuez moscada

art. h. cm.
42720-01 11

Compartment for 7/8 nutmegs.
Serbatoio per 7/8 noci.



AG
W

PALACE Pepper/salt mill

Macina pepe/sale
Pfeffer-/Salzmühle
Moulin à poivre/sel
Molinillo pimienta/sal

art.-P art.-S h. cm.
42725P10 42725S10 10



AG

MIGNONNETTE Pepper/salt mill

Macina pepe/sale
Pfeffer-/Salzmühle
Moulin à poivre/sel
Molinillo pimienta/sal

art.-P art.-S h. cm.
42723P10 42723S10 10

DISPLAY & PRESENTATION

BUFFET





Serving stand, chrome plated

Supporto cromato
Serviergestell, hartverchromt
Présentoir, acier chromé
Soporte platos pastre, acero cromado

art. dim. cm.

44840-01 29x17x41

For 3 plates cm. 18x18 or 21x21.
Per 3 piatti cm. 18x18 oppure 21x21.



Serving stand, chrome plated

Supporto cromato
Serviergestell, hartverchromt
Présentoir, acier chromé
Soporte platos pastre, acero cromado

art. dim. cm.

44840-02 33x21x44

For 3 plates cm. 21x21 or 26,5x26,5.
Per 3 piatti cm. 21x21 oppure 26,5x26,5.



Serving stand, chrome plated

Supporto cromato
Serviergestell, hartverchromt
Présentoir, acier chromé
Soporte platos pastre, acero cromado

art. dim. cm.

44840-03 37x21x44

For 3 plates cm. 30x21. – Per 3 piatti cm. 30x21.



Serving stand, chrome plated

Supporto cromato
Serviergestell, hartverchromt
Présentoir, acier chromé
Soporte platos pastre, acero cromado

art. dim. cm.

44840-04 63x27x44,5

For 2 plates cm. 53x32,5 or 4 plates cm. 53x16,2.
Per 2 piatti cm. 53x32,5 oppure 4 piatti cm. 53x16,2.



Serving stand, chrome plated

Supporto cromato
Serviergestell, hartverchromt
Présentoir, acier chromé
Soporte platos pastre, acero cromado

art. dim. cm.

44840-05 37,5x37,5x50

For plates in 3 different sizes: cm. 21x21-26,5x26,5-37x37. – Per piatti di 3 diverse misure: cm. 21x21-26,5x26,5-37x37.



Serving stand, chrome plated

Supporto cromato
Serviergestell, hartverchromt
Présentoir, acier chromé
Soporte, acero cromado

art. Ø cm. h. cm.

44840-27 22 59

44840-28 22 33

Suitable glasses/Vasetti idonei: 41589C08, 41589C16.



MF

Square bowl

Ciotola quadra
Schüssel, quadratisch
Bol carré
Bol cuadrado

art. dim. cm.

44847B09 9x9x4

44847B13 12,5x12,5x6,5

44847B20 19x19x9





MF

Square bowl

Ciotola quadra
Schüssel, quadratisch
Bol carré
Bol cuadrado

art.	dim. cm.
44847-09	9x9x4
44847-13	12,5x12,5x6,5
44847-20	19x19x9



MF

Round bowl

Ciotola tonda
Schüssel, rund
Bol ronde
Bol redondo

art.	Ø cm.	h. cm.
44846B05	5,5	4,0
44846B09	9,0	4,5
44846B13	13,0	6,5
44846B15	15,0	7,5



MF

Round bowl

Ciotola tonda
Schüssel, rund
Bol ronde
Bol redondo

art.	Ø cm.	h. cm.
44846-05	5,5	4,0
44846-09	9,0	4,5
44846-13	13,0	6,5
44846-15	15,0	7,5



MF

Party plate

Piattino fingerfood
Fingerfood-Teller
Petit assiette
Platillo

art.	dim. cm.	col.
44844-01	9,5x9,5x1,5	○
44844B01	9,5x9,5x1,5	●

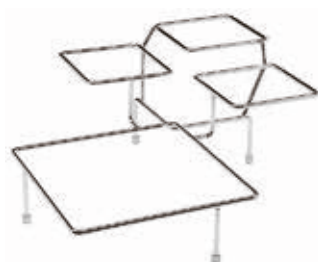

Serving stand, chrome plated

Supporto cromato
Serviergestell, hartverchromt
Présentoir, acier chromé
Soporte platos, acero cromado

art.	dim. cm.
44840-06	39x39x17

For bowls/Per ciotole: 12,5x12,5 e 25x25 cm.



Serving stand, chrome plated

Supporto cromato
Serviergestell, hartverchromt
Présentoir, acier chromé
Soporte platos, acero cromado

art.	dim. cm.
44840-07	55,5x19x15,5

For bowls/Per ciotole: 19x19 cm.



MF

Bowl

Ciotola
Schüssel
Bol
Bol

art.	dim. cm.
44884-12	12,5x12,5x6
44884-19	19x19x9,5
44884-25	25x25x12



MF

Bowl

Ciotola
Schüssel

Bol
Bol

art.	dim. cm.
44884B12	12,5x12,5x6
44884B19	19x19x9,5
44884B25	25x25x12



SAN

Cover

Coperchio
Deckel
Couvercle
Tapa

art.	dim. cm.
44885-19	19x19
44885-25	25x25



GN
MF

Tray

Vassoio
Tablett
Plateau
Bandeja

art.	dim. cm.	GN
44844-11	53x32,5x2,5	1/1



MF

Tray, square

Vassoio quadro
Tablett, quadratisch
Plateau carré
Bandeja, cuadrada

art.	dim. cm.
44841-18	18x18
44841-21	21x21
44841-26	26,5x26,5
44841-37	37x37
44841-51	51x51



MF

Tray, square

Vassoio quadro
Tablett, quadratisch
Plateau carré
Bandeja, cuadrada

art.	dim. cm.
44841B51	51x51



MF

Sushi tray

Vassoio sushi
Sushiplatte
Plateau sushi
Bandeja sushi

art.	dim. cm.
44842B31	31x10,5
44842B53	53x18



MF

Sushi tray

Vassoio sushi
Sushiplatte
Plateau sushi
Bandeja sushi

art.	dim. cm.
44842-31	31x10,5
44842-35	35,5x18
44842-30	30x21
44842-53	53x18



GN
MF

Tray

Vassoio
Tablett
Plateau
Bandeja

art.	dim. cm.
44843-11	53x32,5
44843-12	32,5x26,5
44843-24	53x16,2
44843-13	32,5x17,5
44843-14	26,5x16,2



GN
MF

Tray

Vassoio
Tablett
Plateau
Bandeja

art.	dim. cm.
44843B11	53x32,5
44843B12	32,5x26,5
44843B24	53x16,2
44843B13	32,5x17,5
44843B14	26,5x16,2



MF

Round dish
Piatto tondo
Platte, rund
Plat rond
Bandeja redonda

art.	Ø cm.
44845-51	51
44845-30	30
44845-41	41



MF

Relish dish
Portasalatini
Salzgebäckständer
Porte-appetizers
Soporte entremesas

art.	dim. cm.
44839-05	17x17x16



MF

Relish dish
Portasalatini
Salzgebäckständer
Porte-appetizers
Soporte entremesas

art.	dim. cm.
44839-04	14x14x16



MF

Bowl
Ciotola
Schale
Bol
Bol

art.	Ø cm.	h. cm.	ml.
44466-07	7	6	50



MF

Bowl
Ciotola
Schale
Bol
Bol

art.	dim. cm.	lt.
44466-11	7,5x7x4,5	0,05



MF

Bowl
Ciotola
Schale
Bol
Bol

art.	dim. cm.	lt.
44466-12	11,5x7,5x3	0,06



MF

Bowl
Ciotola
Schale
Bol
Bol

art.	dim. cm.	lt.
44466-13	11,5x6x5,5	0,04



MF

Bowl
Ciotola
Schale
Bol
Bol

art.	dim. cm.	lt.
44466-14	8,5x7x6	0,07



MF

Bowl
Ciotola
Schale
Bol
Bol

art.	dim. cm.	lt.
44466-15	8x8x4	0,1



MF

Bowl
Ciotola
Schale
Bol
Bol

art.	dim. cm.	lt.
44466-16	35x4,5x3	0,2



MF

Party spoon
Cucchiaio finger-food
Finger-food-Löffel
Cuiller
Cucharita

art.	dim. cm.	col.
44850-10	10x4,5	○
44850B10	10x4,5	●



MF

Party spoon
Cucchiaio finger-food
Finger-food-Löffel
Cuiller
Cucharita

art.	dim. cm.	col.
44850-11	11x4,3	○
44850B11	10x4,5	●

BUFFET



MF

Party spoon

Cucchiaio finger-food
Finger-food-Löffel
Cuiller
Cucharita

art.	dim. cm.	col.
44850-13	13,5x4,5	○
44850B13	13,5x4,5	●



MF

Party spoon

Cucchiaio finger-food
Finger-food-Löffel
Cuiller
Cucharita

art.	dim. cm.	col.
44850-12	10x4,5x1	○
44850B12	10x4,5x1	●
44850G12	10x4,5x1	●



MF

Party spoon

Cucchiaio finger-food
Finger-food-Löffel
Cuiller
Cucharita

art.	dim. cm.
44851-01	14,5x4,5



MF

Party spoon

Cucchiaio finger-food
Finger-food-Löffel
Cuiller
Cucharita

art.	dim. cm.	col.
44851-02	14,5x4,5	○
44851-03	14,5x4,5	●



MF

Spoon, set 6 pcs

Cucchiaio, set 6 pz
Löffel, 6er Set
Cuiller, set 6 pcs
Cuchara, set 6 pz

art.	dim. cm.	col.
44850-00	6x23	○
44850W00	6x23	○
44850B00	6x23	●



PVD

SS

Party spoon

Cucchiaio gourmet
Gourmet-Löffel
Cuiller gourmet
Cuchara gourmet

art.	l. cm.	col.
42988-99	13,5	●
42988C99	12,0	●
42988G99	12,0	●



MF

Bowl oval

Pirofila ovale
Schale, oval
Plat oval
Fuente ovale

art.	dim. cm.	lt.
44849-27	27x17x4	0,8
44849-34	34x21x4,5	1,3
44849-47	47x29x5	3,2



MF

Bowl

Insalatiera
Schüssel
Saladier
Bol

art.	Ø cm.	h. cm.
44836-30	30	10



MF

Bowl
Insalatiera
Schüssel
Saladier
Bol

art. dim. cm.
44834-03 40x18,5x10



MF

Plate
Piatto
Platte
Plaque
Plato

art. dim. cm.
44835-36 36x16x3
44835-45 45x24x3
44835-53 53x29x3,5



MF

Plate
Piatto
Platte
Plaque
Plato

art. dim. cm.
44834-00 34,5x8x2,5



MF

Plate
Piatto
Platte
Plaque
Plato

art. dim. cm.
44834-01 40x18,5x3,5
44834-02 52x25x4



MF

Bowl
Insalatiera
Schüssel
Saladier
Bol

art. Ø cm. h. cm.
44836G30 30 10



MF

Bowl
Insalatiera
Schüssel
Saladier
Bol

art. dim. cm.
44834G03 40x18,5x10



MF

Plate
Piatto
Platte
Plaque
Plato

art. dim. cm.
44835G36 36x16x3
44835G45 45x24x3
44835G53 53x29x3,5



MF

Plate
Piatto
Platte
Plaque
Plato

art. dim. cm.
44834G00 34,5x8x2,5



MF

Plate
Piatto
Platte
Plaque
Plato

art. dim. cm.
44834G01 40x18,5x3,5
44834G02 52x25x4





Mirror shiny inside, outside matt.

Interno lucido, esterno satinato.



Bowl

Ciotola
Schale
Bol
Bol

art.	dim. cm.	lt.	col.
44449-32	32,5x17,5x10	1,8	○
44449B32	32,5x17,5x10	1,8	●



Bowl

Ciotola
Schale
Bol
Bol

art.	dim. cm.	lt.	col.
44449-30	30,5x30,5x10	3,3	○
44449B30	30,5x30,5x10	3,3	●



Bowl

Ciotola
Schale
Bol
Bol

art.	dim. cm.	col.
44446-10	10,5x10x6,5	○
44446-14	13,5x12,5x8,5	○
44446-18	17x16x10,5	○



Bowl

Ciotola
Schale
Bol
Bol

art.	dim. cm.	col.
44446B10	10,5x10x6,5	●
44446B14	13,5x12,5x8,5	●
44446B18	17x16x10,5	●



Tray

Vassoio
Tablett
Plateau
Bandeja

art.	dim. cm.	col.
44842-31	31x10,5x2	○
44842B31	31x10,5x2	●



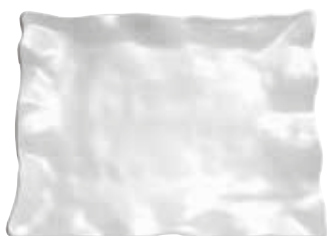

Tray, rectangular
Vassoio rettangolare
Tablett, rechteckih
Plateau rectangulaire
Bandeja rectangular

art.	dim. cm.
44886-38	38,5x29,5x5
44886-44	44x34,5x5



Tray, square
Vassoio quadro
Tablett, quadratisch
Plateau carré
Bandeja, cuadrada

art.	dim. cm.
44886-30	30,5x30,5x4
44886-36	36x36x5
44886-34	44x34,5x5



Bowl
Ciotola
Schale
Bol

art.	dim. cm.
44889-32	32,5x32,5x12
44889-35	35x35x12,5
44889-40	40x40x14



Bowl
Ciotola
Schale
Bol

art.	dim. cm.
44887-32	32x32x12
44887-36	36x36x12,5



Bowl
Ciotola
Schale
Bol

art.	Ø cm.	h. cm.
44888-32	32	16,5
44888-35	35	17,0
44888-40	40	17,5



Bowl
Ciotola
Schale
Bol

art.	dim. cm.	lt.
44882-35	35,5x31,5x14	2,5
44882-46	46x40x18,5	5,5

NEW



Withstands temperatures from -20°C to +70°C.

Termoresistenti da -20°C a +70°C.



Platter
Plancia
Tablett
Plateau
Bandeja

art.	dim. cm.	GN
44470-11	53,0x32,5x1	1/1
44470-24	53,0x16,2x1	2/4
44470-12	32,5x26,5x1	1/2
44470-13	32,5x17,5x1	1/3
44470-14	26,5x16,5x1	1/4

Serving board
Tagliere
Servier-Brett
Planche
Tabla

art.	Ø cm.	h. cm.
44470-30	30	1
44470-40	40	1

Bowl

Ciotola
Schüssel
Bol
Bol Ensalada

art.	dim. cm.	lt.
44470-03	19x19x9	1,5
44470-04	25x25x12	3,8

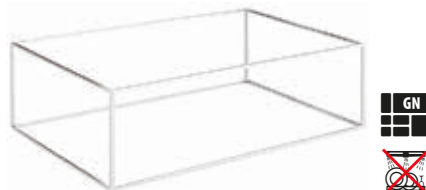

Platter
Plancia
Tablett
Plateau
Bandeja

art.	dim. cm.
44470-73	20x10x2
44470-74	30x10x2
44470-75	30x15x2

Stand chromed
Alzata cromata
Ständer, verchromt
Support chromé
Soporte cromado

art.	dim. cm.	GN
44840-50	53x32,5-53x16,5	1/1-2/4
44840-51	32,5x26,5-26,5x16,2	1/2-1/4
44840-52	32,5x17,5-35,4x32,5	1/3-2/3





Stand
Alzata
Ständer
Support
Soporte

art.	dim. cm.	GN
44840-55	53x32,5-53x16,5	1/1-2/4
44840-56	32,5x26,5-26,5x16,2	1/2-1/4
44840-57	32,5x17,5-35,4x32,5	1/3-2/3

Black coating. – Rivestimento nero.



Stand chromed
Alzata cromata
Ständer, verchromt
Support chromé
Soporte cromado

art.	Ø cm.	h. cm.
44478-77	38,0	16,5
44478-79	48,5	16,5



Stand chromed
Alzata cromata
Ständer, verchromt
Support chromé
Soporte cromado

art.	Ø cm.	h. cm.
44478-78	38,0	27
44478-80	48,5	27



Tray
Vassoio
Tablett
Plateau
Bandeja

art.	Ø cm.	h. cm.
44478-70	30,0	3
44478-71	38,0	3
44478-72	48,5	3



Tray
Vassoio
Tablett
Plateau
Bandeja

art.	Ø cm.	h. cm.
44478-73	38,0	2,5
44478-74	48,5	2,5



Intermediate tray
Vassoio intermedio
Zwischenplatte
Plateau intermédiaire
Bandeja intermedia

art.	Ø cm.	h. cm.
44478-75	38,0	2,5
44478-76	48,5	2,5



Plate
Piatto
Teller
Assiette
Plato

art.	Ø cm.	h. cm.
44477-24	11,0	2
44477-25	16,0	2
44477-26	19,5	2
44477-27	24,0	2
44477-28	28,0	2



Bowl
Ciotola
Schüssel
Bol
Bol

art.	Ø cm.	h. cm.	lt.
44477-40	7,5	3,0	0,04
44477-41	7,5	6,5	0,13
44477-44	23,0	3,0	0,40



Bowl
Ciotola
Schüssel
Bol
Bol

art.	dim. cm.	lt.
44477-52	7,5x7,5x3	0,05
44477-53	7,5x7,5x6,5	0,16
44477-54	15,5x15,5x3	0,19
44477-55	15,5x15,5x6,5	0,85

BUFFET



Bowl
Ciotola
Schüssel
Bol
Bol

art.	dim. cm.	lt.
44477-64	15,5x7,5x3	0,10
44477-65	15,5x7,5x6,5	0,40
44477-66	15,5x9,5x3	0,15
44477-67	15,5x9,5x6,5	0,50
44477-68	25x15,5x3	0,30
44477-69	25x15,5x6,5	1,40



Tray
Vassoio
Tablett
Plateau
Bandeja

art.	dim. cm.	GN
44477-76	53x32,5x3	1/1
44477-77	32,5x26,5x3	1/2
44477-78	32,5x17,6x3	1/3
44477-79	26,5x16,2x3	1/4
44477-80	35,4x32,5x3	2/3
44477-81	53x16,2x3	2/4



Buffet diplay
Display per buffet
Büffetgestell
Etagère à buffet
Expositor para buffet

art.	dim. cm.
41870-01	54x47x63

Shelves/Ripiani: 47x34 - 37x25 - 27x17 - 23x13 cm.



Buffet diplay
Display per buffet
Büffetgestell
Etagère à buffet
Expositor para buffet

art.	Ø cm.	h. cm.
41870-03	28	29

Shelves/Ripiani: 38x30x21 - 38x30x13 - 38x30x5 cm.



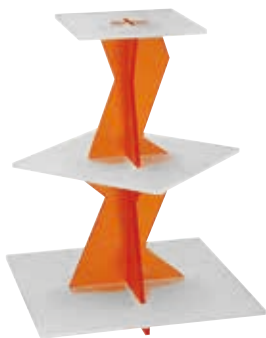

Buffet display

Display per buffet
Büffetgestell
Etagère à buffet
Expositor para buffet

art. dim. cm.
41870-02 40x40x53

Shelves/Ripiani: 40x40 - 30x30 - 22x22 - 27x17 - 23x13 cm.



Buffet display

Display per buffet
Büffetgestell
Etagère à buffet
Expositor para buffet

art. dim. cm.
41870-04 40x27x29

Shelves/Ripiani: 40x27x21 - 40x27x13 - 40x27x5 cm.



Buffet display, set 3 pcs

Display per buffet, set 3 pezzi
Büffetgestell, 3er Set
Etagère à buffet, set 3 pcs
Expositor para buffet, set 3 pz

art. dim. cm.
41919-03 40x18x4
40x20x8
40x22x12



Stand

Alzata
Ständer
Support
Soporte

art. h. cm.
44840-30 8
44840-31 12
44840-32 18

Black anti-slide coating.
Rivestimento antiscivolo nero.



Stand

Alzata
Ständer
Support
Soporte

art. Ø cm. h. cm.
44840-40 15,5-18 8
44840-41 15,5-18 10
44840-42 15,5-18 18

Black anti-slide coating.
Rivestimento antiscivolo nero.



Basket

Cesto
Korb
Panier
Cesta

art. Ø cm. h. cm.
44476-20 21-16,5 21

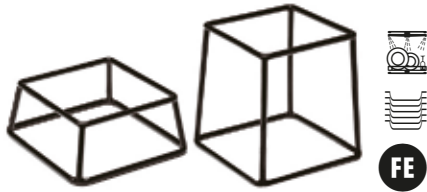

FE

Stand
Alzata
Ständer
Support
Soporte

art.	dim. cm.
44840-08	18x18x8
44840-10	18x18x10
44840-18	18x18x18

Black anti-slide coating.
Rivestimento antiscivolo nero.



SS

Stand/basket
Alzata/cesto
Ständer/Korb
Support/panier
Soporte/cesta

art.	Ø cm.	h. cm.
44476-26	21	10,5
44476-28	21	20,0



SS

Stand/basket
Alzata/cesto
Ständer/Korb
Support/panier
Soporte/cesta

art.	Ø cm.	h. cm.	col.
44476-27	21	10,5	●
44476-29	21	20,0	●



FE

Stand/basket chromed
Alzata/cesto cromato
Ständer/Korb, verchromt
Support/panier, chromé
Soporte/cesta cromado

art.	Ø cm.	h. cm.
44476-30	15	10,5
44476-31	21	20,0



FE

Stand/basket
Alzata/cesto
Ständer/Korb
Support/panier
Soporte/cesta

art.	Ø cm.	h. cm.	col.
44476-32	15	10,5	●
44476-33	21	20,0	●



NEW

FE



Stand/basket
Alzata/cesto
Ständer/Korb
Support/panier
Soporte/cesta

art.	Ø cm.	h. cm.	col.
44476-51	10,5-8	8	●



NEW

FE



Stand/basket

Alzata/cesto
Ständer/Korb
Support/panier
Soporte/cesta

art. Ø cm. h. cm. col.

44476-52 10,5-8 8 ●



NEW

FE



Stand/basket

Alzata/cesto
Ständer/Korb
Support/panier
Soporte/cesta

art. Ø cm. h. cm. col.

44476-53 10,5-8 8 ●



W

Stand

Alzata
Ständer
Support
Soporte

art. dim. cm.

42463A00 20x20x17,5

Acacia wood.



W

Stand

Alzata
Ständer
Support
Soporte

art. dim. cm.

42463B00 20x20x17,5

Acacia wood.



NEW



Bowl

Ciotola
Schüssel
Bol
Bol

art. Ø cm. h. cm. lt.

41446-18 18 9,5 1,0

41446-23 23 12,5 2,2

Beton. – Cemento.



NEW

W

Stand

Alzata
Ständer
Support
Soporte

art. Ø cm. h. cm.

41445-01 15 10

41445-02 35 15

Acacia wood.



NEW



Bowl

Ciotola
Schüssel
Bol
Bol

art. Ø cm. h. cm. lt.

41445-22 22,0 10,5 1,1

41445-26 26,0 13,0 1,7

41445-30 29,5 14,5 2,5

Beton. – Cemento.

ACRYLIC MIRRORS
SPECCHI ACRILICI PMMA



Mirror, square

Specchio quadrato
Spiegel, quadratisch
Miroir carré
Espejo cuadrado

art.	dim. cm.
41885-30	30x30
41885-40	40x40
41885-45	45x45
41885-50	50x50
41885-60	60x60



Mirror, oval

Specchio ovale
Spiegel, oval
Miroir ovale
Espejo oval

art.	dim. cm.
41877-45	45x30
41877-61	61x45,5
41877-81	81x61
41877-99	100x70



Mirror, rectangular

Specchio rettangolare
Spiegel, rechteckig
Miroir rectangulaire
Espejo rectangular

art.	dim. cm.
41878-45	45x30
41878-61	61x46
41878-81	81x58,5
41878-99	100x70



Mirror, octagon

Specchio ottagonale
Spiegel, achteckig
Miroir octogonal
Espejo octogonal

art.	Ø cm.
41879-30	30
41879-40	40
41879-50	50
41879-61	61



Mirror, hexagon

Specchio esagono
Spiegel, Sechseck
Miroir hexagon
Espejo hexágono

art.	Ø cm.
41880-38	38
41880-61	61



Mirror, comma

Specchio virgola
Spiegel, Komma
Miroir virgule
Espejo vírgula

art.	Ø cm.
41875-40	40,6
41875-61	61,0



Mirror, segment

Specchio spicchio
Spiegel, Segment
Miroir quartier
Espejo segmento

art.	Ø cm.
41881-30	30,5
41881-40	40,5



Mirror, circle

Specchio cerchio
Spiegel, Kreis
Miroir cercle
Espejo aro

art.	Ø cm.
41876-30	30,5
41876-38	38,0
41876-45	45,0
41876-58	58,0



Mirror, cube

Specchio cubo
Spiegel, Würfel
Miroir cube
Espejo cubo

art.	dim. cm.
41882-15	15x15x15
41882-20	20x20x20
41882-25	25x25x25
41882-30	30x30x30



NEW
W
FE

Set 2 lanterns

Set 2 lanternen
Set 2 laternen
Set 2 lanternes
Set 2 linternas

art.	dim. cm.
42440-30	22x20x52 30x26x71



NEW
W
FE

Set 2 lanterns

Set 2 lanternen
Set 2 laternen
Set 2 lanternes
Set 2 linternas

art.	dim. cm.
42441-25	17x17x44 25x25x62



NEW
W
FE

Set 2 lanterns

Set 2 lanternen
Set 2 laternen
Set 2 lanternes
Set 2 linternas

art.	dim. cm.
42442-24	17x17x45 24x24x67



NEW



Set 3 candele

Set 3 candles
Kunstkerzen, 3er Set
Set 3 bougies
Set 3 velas

art.	Ø cm.	h. cm.
42445-03	9	12,5
	9	18
	9	23

Resin. Timer function 5 hours ON/19 OFF. Powered by 2D alkaline batteries (not incl.). Working time >800 hours. Flameless moving wick. – Resina. Funzione timer 5 ore ON/19 OFF. 2 batterie alcaline D (non include). Durata > 800 ore. Stoppino mobile senza fiamma.



Tray stand, chromed

Stand per vassoi, cromato
Tablett-Träger, verchromt
Porte plateaux, chromé
Soporte para bandejas, cromado

art.	dim. cm.
44093-00	38x 48x74



Tray stand

Stand per vassoi
Tablett-Träger
Porte plateaux
Soporte para bandejas

art.	dim. cm.
44093-01	42x43x82



Newspaper stick

Portagiornale
Zeitungshalter
Canne à journaux
Varilla portaperiodico

art.	l. cm.	col.
48287-18	75	●
48287-19	75	●



PP

Tray, rectangular

Vassoio rettangolare
Serviertablett, rechteckig
Plateau rectangulaire
Bandeja rectangular

art.	dim. cm.
41860-36	27x36,5
41860-43	30,7x43,5
41860-47	35,5x47



PP

Tray, rectangular

Vassoio rettangolare
Serviertablett, rechteckig
Plateau rectangulaire
Bandeja rectangular

art.	dim. cm.
41861-44	30,7x44



NEW

W

Breakfast tray with legs

Vassoio colazione con gambe
Frühstückstablett mit Beinen
Plateau petit déjeuner avec jambes
Bandeja desayuno con patas

art.	dim. cm.	col.
19902-38	58,5x38,5x30	●

Walnut. – Noce.



W

Room service tray
Vassoio room service
Zimmerservice-Tablett
Plateau room-service
Bandeja room service

art.	dim. cm.	col.
19901-35	52x35	●
19901-40	60x40	●
19901-47	71x47	●

Walnut. – Noce.



GN
SS

Tray
Vassoio
Tablett
Plateau
Bandeja

art.	dim. cm.	GN
41430-11	53x32,5x5	1/1

Chrome plated handles. Useful height 4 cm.
Maniglie cromate. Altezza utile 4 cm.



GN
SS

Tray
Vassoio
Tablett
Plateau
Bandeja

art.	dim. cm.	GN
41436-11	53x32,5	1/1
41436-12	32,5x26,5	1/2



GN
SS

Tray, deko-edge
Vassoio bordo Deko
Tablett, Dekorrand
Plateau avec décor
Bandeja, borde decorado

art.	dim. cm.	GN
41437-11	53x32,5	1/1
41437-12	32,5x26,5	1/2



SS

Tray, deko-edge
Vassoio bordo Deko
Tablett, Dekorrand
Plateau avec décor
Bandeja, borde decorado

art.	Ø mm.
41439-32	32
41439-38	38
41439-48	48



SS

Tray, deko-edge
Vassoio bordo Deko
Tablett, Dekorrand
Plateau avec décor
Bandeja, borde decorado

art.	dim. cm.
41438-50	50x36
41438-60	60x41
41438-70	70x46



SS

Fish tray
Vassoio pesce
Fischplatte
Plat à poisson
Salmonera

art.	dim. cm.
66345-55	55x23
66345-65	65x27
66345-74	74x29



SS

Fish tray
Vassoio pesce
Fischplatte
Plat à poisson
Salmonera

art.	dim. cm.
41654-80	80x31
41654-99	100x35



SS

Tray, oval
Vassoio ovale
Tablett, oval
Plateau ovale
Bandeja oval

art.	dim. cm.
41651-20	20x14
41651-25	25x18
41651-30	30x22
41651-35	35x22
41651-40	40x26



SS

Tray, oval
Vassoio ovale
Tablett, oval
Plateau ovale
Bandeja oval

art.	dim. cm.
41651-45	45x29
41651-50	50x35
41651-55	55x38
41651-60	60x42
41651-65	65x45



SS

Tray, round
Vassoio tondo
Tablett, rund
Plateau rond
Bandeja redonda

art.	Ø cm.
66326-30	30
66326-35	35
66326-40	40
66326-60	60
66326-80	80



SS

Tray, oval
Vassoio ovale
Tablett, oval
Plateau ovale
Bandeja oval

art.	dim. cm.
66325-30	30x19
66325-35	35x22
66325-41	41x26
66325-46	46x29
66325-54	54x37
66325-85	85x58
66325-99	100x68



SS

Tray, rectangular
Vassoio rettangolare
Serviertablett, rechteckig
Plateau rectangulaire
Bandeja rectangular

art.	dim. cm.
66320-28	28x20
66320-35	35x30
66320-40	40x26
66320-50	50x38
66320-65	65x50
56020-85	85x50
56020-99	100x50



SS

Tray, rectangular
Vassoio rettangolare
Serviertablett, rechteckig
Plateau rectangulaire
Bandeja rectangular

art.	dim. cm.
66324-40	40x26
66324-50	50x38
66324-65	65x50
56024-85	85x50
56024-99	100x50

BUFFETSYSTEM



Cool plate

Vetrina refrigerata
Büffet-Vitrine, kühlbar
Vitrine réfrigérée
Vitrina refrigerada

art. dim. cm. GN
42450-00 53x32,5x8,5 1/1

GN 1/1 base element, s/s platter, cooler.
Base GN 1/1, vassoio inox, eutettico.

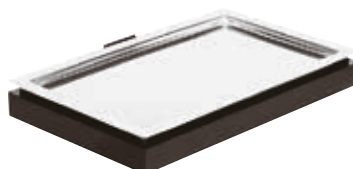

Cool plate

Vetrina refrigerata
Büffet-Vitrine, kühlbar
Vitrine réfrigérée
Vitrina refrigerada

art. dim. cm. GN
42460-00 53x32,5x8,5 1/1

GN 1/1 base element, s/s platter, cooler.
Base GN 1/1, vassoio inox, eutettico.



Cool plate

Vetrina refrigerata
Büffet-Vitrine, kühlbar
Vitrine réfrigérée
Vitrina refrigerada

art. dim. cm. GN
42470-00 53x32,5x8,5 1/1

GN 1/1 base element, s/s platter, cooler.
Base GN 1/1, vassoio inox, eutettico.



GN roll-top cover

Coperchio GN roll-top
GN-Rolltophaube
Couvercle roll-top, GN
Tapa roll-top, GN

art. GN
42452-53 1/1



Tray

Vassoio
Tablett
Plateau
Bandeja

art. GN
42451-11 1/1
42451-12 1/2

BUFFET



W

Cutting board
Tagliere
Tranchierbrett
Planche à découper
Plancha para cortar

art. GN
42470-06 1/1



W

Cutting board
Tagliere
Tranchierbrett
Planche à découper
Plancha para cortar

art. GN
42470-07 1/1



PE

Cutting board
Tagliere
Tranchierbrett
Planche à découper
Plancha para cortar

art. GN
42460-06 1/1



W

Box with bowl
Espositore con ciotola
Schüssel-Box
Boîte avec bol
Box con bol

art.	dim. cm.	col.
42460-16	17,4x17,4x6	●
42470-16	17,4x17,4x6	●

Base with white melamine bowl ø 14 cm.
Base con ciotola melamina bianca ø 14 cm.



W

Box with bowl
Espositore con ciotola
Schüssel-Box
Boîte avec bol
Box con bol

art.	dim. cm.	col.
42460-14	26,5x26,5x8,5	●
42470-14	26,5x26,5x8,5	●

Base with white melamine bowl ø 23 cm.
Base con ciotola melamina bianca ø 23 cm.



W

Box with bowl
Espositore con ciotola
Schüssel-Box
Boîte avec bol
Box con bol

art.	Ø cm.	h. cm.	col.
42460-20	17,4	6	●
42470-20	17,4	6	●

Base with white melamine bowl ø 14 cm.
Base con ciotola melamina bianca ø 14 cm.



W

Box with bowl
Espositore con ciotola
Schüssel-Box
Boîte avec bol
Box con bol

art.	Ø cm.	h. cm.	col.
42460-18	26,6	8,5	●
42470-18	26,6	8,5	●

Base with white melamine bowl ø 23 cm.
Base con ciotola melamina bianca ø 23 cm.



MF

Bowl
Ciotola
Schüssel
Bol
Bol

art.	Ø cm.	h. cm.	lt.	col.
44837B05	14	6,5	0,5	●
44837B20	20	9,2	1,8	●
44837B25	23	10,0	2,5	●



MF

Bowl
Ciotola
Schüssel
Bol
Bol

art.	Ø cm.	h. cm.	lt.	col.
44837-05	14	6,5	0,5	○
44837-20	20	9,2	1,8	○
44837-25	23	10,0	2,5	○



Bowl, glass
Ciotola, vetro
Glasschüssel
Bol en verre
Bol vidrio

art.	Ø cm.	h. cm.	lt.
41425-AA	7,5	3,5	0,09
41405-AA	14,0	6,5	0,5
41400-AA	23,0	10,0	2,5



PC

Airtight cover
Coperchio ermetico
Frischhaltedeckel
Couvercle hermétique
Tapa hermética

art.	Ø cm.
42452-14	14
42452-23	23



PC

Cover
Coperchio
Deckel
Couvercle
Tapa

art.	Ø cm.
42453-23	23



SAN

Cover

Coperchio
Deckel
Couvercle
Tapa

art. Ø cm.
44837C20 20,5

Matches/Per: 44837-20 & 44837B20.



Eutectic pad

Accumulatore di freddo
Kühlakku
Cartouche eutectique
Placa eutética

art. dim. cm.
42450-AD 41x21x2,5

**BUFFET
DISPLAY & PRESENTATION**



W

Buffet stand

Espositore buffet
Buffetgestell
Présentoir
Expositor de buffet

art. dim. cm.
42460-53 53x21x50

Shelves/Ripiani: 30 x 15 - 40 x 17,5 - 53 x 19 cm.



W

Buffet stand

Espositore buffet
Buffetgestell
Présentoir
Expositor de buffet

art. dim. cm.
42470-53 53x21x50

Shelves/Ripiani: 30 x 15 - 40 x 17,5 - 53 x 19 cm.



W

Cereal-bar

Espositore cereali
Cerealien-Buffer-Ständer
Présentoir à céréales
Expositor de cereale

art. dim. cm. col.
42470-43 43x17x13,5 ●

**2 glasses lt. 2 with airtight cover.
2 vasi lt. 2 con coperchio ermetico.**



W

Cereal-bar

Espositore cereali
Cerealien-Buffer-Ständer
Présentoir à céréales
Expositor de cereale

art. dim. cm. col.
42460-43 43x17x13,5 ●

**3 glasses lt. 2 with airtight cover.
3 vasi lt. 2 con coperchio ermetico.**



W

Juice dispenser

Distributore di succhi
Saftdispenser
Distributeur à jus de fruit
Dispensador de zumo

art. dim. cm. lt. col.
42470-74 31x20x42 4 ●
42470-76 35,5x22x50 6 ●

**With 2 cooling elements, top and base.
Con 2 eutettici, coperchio e base.**



W

Juice dispenser

Distributore di succhi
Saftdispenser
Distributeur à jus de fruit
Dispensador de zumo

art. dim. cm. lt. col.
42460-74 31x20x42 4 ●
42460-76 35,5x22x50 6 ●

**With 2 cooling elements, top and base.
Con 2 eutettici, coperchio e base.**



W

Cereal dispenser

Distributore di cereali
Cerealienenspender
Distributeur à céréales
Dispensador de cereales

art. dim. cm. lt. col.
42470-45 21x20x55,5 4,5 ●
42460-45 21x20x55,5 4,5 ●

BUFFET



Cooled buffet showcase

Vetrina refrigerata
Büffet-Vitrine, kühlbar
Vitrine réfrigérée
Vitrina refrigerada

art.	dim. cm.	col.
42470-63	63,5x42,5x31	●

Woodabse with fixed roll-top cover, plastic case, GN 1/1 melamine tray, cooling unit. – Base legno con coperchio roll-top fisso, vasca plastica, GN 1/1 in melamina, placca eutettica.



Cooled buffet showcase

Vetrina refrigerata
Büffet-Vitrine, kühlbar
Vitrine réfrigérée
Vitrina refrigerada

art.	dim. cm.	col.
42460-63	63,5x42,5x31	●

Woodabse with fixed roll-top cover, plastic case, GN 1/1 melamine tray, cooling unit. – Base legno con coperchio roll-top fisso, vasca plastica, GN 1/1 in melamina, placca eutettica.



Cool bowl

Ciotola refrigerata
Kühlschale
Bol réfrigérée
Bol refrigerada

art.	dim. cm.	lt.	col.
42470-26	18,5x18,5x10	0,5	●
42470-27	27,5x27,5x14	2,5	●

Wood base, s/s container, melamine bowl, cooling unit. – Base legno, contenitore inox, ciotola melamina, placca eutettica.



Cool bowl

Ciotola refrigerata
Kühlschale
Bol réfrigérée
Bol refrigerada

art.	dim. cm.	lt.	col.
42460-26	18,5x18,5x10	0,5	●
42460-27	27,5x27,5x14	2,5	●

Wood base, s/s container, melamine bowl, cooling unit. – Base legno, contenitore inox, ciotola melamina, placca eutettica.



Cutlery dispenser

Portaposate
Besteck-Behälter
Bac à couverts
Caja portacubiertos

art.	dim. cm.	col.
42470-64	57,5x47x12	●



Cutlery dispenser

Portaposate
Besteck-Behälter
Bac à couverts
Caja portacubiertos

art.	dim. cm.	col.
42460-64	57,5x47x12	●



Hygienic cover

Copertura igienica
Hygieneschutz
Couverture d'hygiène
Cobertura d'higiene

art.	dim. cm.
42873-65	65x39x42

Chrome plated wire stand. – Supporto cromato.



Ice-box, 3 pcs set

Box portaggiaccio, set 3 pz
Eisbox, 3-teilig
Boîte à glaçons, 3 pièces
Cubitera, 3 elementos

art.	dim. cm.
41412-11	53x32,5x12,5

Box wenge + plastic deep tray + drainer plate.
Base wengé + vasca plastica + griglia.



Cooled yogurt dispenser

Porta yogurt refrigerato
Yogurt-Ständer, kühlbar
Rafraichissoir à yogurt
Enfriador para yogurt

art.	Ø cm.
58402-33	33
58402-40	40

BUFFET SYSTEM



ACACIA WOOD for a multifunctional buffet system that adapts in height and width to all space requirements. The stackable and non-slip reversible boxes can be used individually or connected with flat GN trays.

LEGNO DI ACACIA per un sistema multifunzionale che si adatta in altezza e larghezza a tutte le esigenze di spazio. Le scatole reversibili, impilabili e antiscivolo possono essere utilizzate singolarmente o collegate con i piani GN.



Box
Scatola
Wendebox
Boîte
Caja

art.	dim. cm.	GN
42463A02	55,5x35x10,5	1/1



Box
Scatola
Wendebox
Boîte
Caja

art.	dim. cm.	GN
42463A04	55,5x18,5x10,5	2/4



Box
Scatola
Wendebox
Boîte
Caja

art.	dim. cm.	GN
42463A05	35x29x10,5	1/2



Box
Scatola
Wendebox
Boîte
Caja

art.	dim. cm.	GN
42463A08	29x18,5x10,5	1/4



Box
Scatola
Wendebox
Boîte
Caja

art.	dim. cm.	GN
42463B02	55,5x35x10,5	1/1



Box
Scatola
Wendebox
Boîte
Caja

art.	dim. cm.	GN
42463B04	55,5x18,5x10,5	2/4



Box

Scatola
Wendebox
Boîte
Caja

art.	dim. cm.	GN
42463B05	35x29x10,5	1/2



Box

Scatola
Wendebox
Boîte
Caja

art.	dim. cm.	GN
42463B08	29x18,5x10,5	1/4



W

Pretzel stand

Porta Brezel
Brezel- oder Wurstständer
Support à brezel
Soporte para brezel

art.	Ø cm.	h. cm.
42870-50	22	50

Beechwood. – Faggio.



AY

Hygienic cover

Copertura igienica
Hygieneschutz
Couverture d'hygiène
Cobertura d'higiene

art.	dim. cm.
42870-51	20x20x50



AY

SS

Bread roll-dispenser

Distributore panini
Brötchen-Spender
Distributeur à pain
Dispensador de pan

art.	dim. cm.
42963-55	32x22x55

For/Per: 65-70 pcs.



W

Bread slicer

Taglia pane
Brotschneidergerät
Coupe-pain
Corta-pan

art.	dim. cm.
49833-00	41x15x10



PP

Bread basket

Cesta baguettes
Brotkorb
Corbeille à pain
Cesta pan

art.	dim. cm.	GN	col.
42462-11	53x32,5x6,5	1/1	●
42462-12	32,5x26,5x6,5	1/2	●
42462-13	32,5x17,5x6,5	1/3	●
42462-14	26,4x16,2x6,5	1/4	●
42462-16	17,6x16,2x6,5	1/6	●
42462-23	32,5x35,4x6,5	2/3	●



PP

Bread basket

Cesta baguettes
Brotkorb
Corbeille à pain
Cesta pan

art.	dim. cm.	GN	col.
42463-11	53x32,5x10	1/1	●
42463-12	32,5x26,5x10	1/2	●
42463-13	32,5x17,5x10	1/3	●
42463-14	26,4x16,2x10	1/4	●
42463-16	17,6x16,2x10	1/6	●
42463-23	32,5x35,4x10	2/3	●



Bread basket
Cesta baguettes
Brotkorb
Corbeille à pain
Cesta pan

art.	dim. cm.	GN	col.
42967-63	53x32,5x6,5	1/1	●
42967-64	32,5x26,5x6,5	1/2	●
42967-65	32,5x17,5x6,5	1/3	●
42967-66	26,4x16,2x6,5	1/4	●
42967-67	17,6x16,2x6,5	1/6	●
42967-68	32,5x35,4x6,5	2/3	●

Bread basket
Cesta baguettes
Brotkorb
Corbeille à pain
Cesta pan

art.	dim. cm.	GN	col.
42967-73	53x32,5x10	1/1	●
42967-74	32,5x26,5x10	1/2	●
42967-75	32,5x17,5x10	1/3	●
42967-76	26,4x16,2x10	1/4	●
42967-77	17,6x16,2x10	1/6	●
42967-78	32,5x35,4x10	2/3	●



Bread basket
Cesta baguettes
Brotkorb
Corbeille à pain
Cesta pan

art.	dim. cm.	GN	col.
42967-03	53x32,5x6,5	1/1	●
42967-04	32,5x26,5x6,5	1/2	●
42967-05	32,5x17,5x6,5	1/3	●
42967-06	26,4x16,2x6,5	1/4	●
42967-07	17,6x16,2x6,5	1/6	●
42967-08	32,5x35,4x6,5	2/3	●

Bread basket
Cesta baguettes
Brotkorb
Corbeille à pain
Cesta pan

art.	dim. cm.	GN	col.
42967-13	53x32,5x10	1/1	●
42967-14	32,5x26,5x10	1/2	●
42967-15	32,5x17,5x10	1/3	●
42967-16	26,4x16,2x10	1/4	●
42967-17	17,6x16,2x10	1/6	●
42967-18	32,5x35,4x10	2/3	●



Bread basket
Cesto pane
Brot-Korb
Corbeille à pain
Cesta pan

art.	dim. cm.	l. cm.
42973-30	30x40	16/27

Bread basket
Cesto pane
Brot-Korb
Corbeille à pain
Cesta pan

art.	dim. cm.	l. cm.
42973-45	45x40	16/27
42973-61		

Bread basket
Cesto pane
Brot-Korb
Corbeille à pain
Cesta pan

art.	dim. cm.	l. cm.
42973-60	60x40	16/27



Bread basket
Cesta baguettes
Brotkorb
Corbeille à pain
Cesta pan

art.	cap. kg.	l. cm.
42967-35	35	25/42



Bread basket
Cesta baguettes
Brotkorb
Corbeille à pain
Cesta pan

art.	cap. kg.	l. cm.
42972-28	30	38



Bread basket
Cesta baguettes
Brotkorb
Corbeille à pain
Cesta pan

art.	cap. kg.	l. cm.
42968-38	38	10



Bread basket
Cesta baguettes
Brotkorb
Corbeille à pain
Cesta pan

art.	cap. kg.	l. cm.
42968-42	42	12



Bread basket
Cesta baguettes
Brotkorb
Corbeille à pain
Cesta pan

art.	cap. kg.	l. cm.
42969-31	31/37	6/12



Bread basket
Cesta baguettes
Brotkorb
Corbeille à pain
Cesta pan

art.	cap. kg.	l. cm.
42969-36	36,5	12



Bread basket
Cesta baguettes
Brotkorb
Corbeille à pain
Cesta pan

art.	dim. cm.	h. cm.
42967-43	45x42	17/24



Bread basket
Cesta baguettes
Brotkorb
Corbeille à pain
Cesta pan

art.	dim. cm.
42972-01	40x20x5
42972-02	40x30x5
42972-03	60x20x5
42972-04	60x40x5



Bread basket
Cesta baguettes
Brotkorb
Corbeille à pain
Cesta pan

art.	dim. cm.
42967-53	53x32,5x15,5



Bread basket
Cesta baguettes
Brotkorb
Corbeille à pain
Cesta pan

art.	dim. cm.
42936-23	23x19x9



Bread basket
Cesta baguettes
Brotkorb
Corbeille à pain
Cesta pan

art.	dim. cm.
42936-24	24x17x8
42936-28	28x16x8,5



Bread basket
Cesta baguettes
Brotkorb
Corbeille à pain
Cesta pan

art.	dim. cm.
42946-23	23x10x6
42946-37	37,5x15x7



Bread basket
Cesta baguettes
Brotkorb
Corbeille à pain
Cesta pan

art.	dim. cm.
42947-23	23x15x7
42947-30	30x22x7
42947-40	41x29x7



Bread basket
Cesta baguettes
Brotkorb
Corbeille à pain
Cesta pan

art.	dim. cm.	GN
42969-11	53,5x32,5x9,5	1/1



Bread basket
Cesta baguettes
Brotkorb
Corbeille à pain
Cesta pan

art.	dim. cm.	GN
42965-12	32,5x26,5x8	1/2



Bread basket
Cesta baguettes
Brotkorb
Corbeille à pain
Cesta pan

art.	dim. cm.	GN
42967-11	56,5x36x10	1/1

With frame to fix the cover.
Con telaio per fissare il coperchio.



Roll-top cover
Coperchio roll-top
Rolltophaube
Couvercle roll-top
Tapa roll-top

art.	dim. cm.	GN
41415-11	53x32,5x17	1/1

Chrome knob. – Pomolo cromato.



Bread basket
Cesta baguettes
Brotkorb
Corbeille à pain
Cesta pan

art.	dim. cm.	GN
42461-11	56,5x36x10	1/1

With frame to fix the cover.
Con telaio per fissare il coperchio.



Roll-top cover
Coperchio roll-top
Rolltophaube
Couvercle roll-top
Tapa roll-top

art.	dim. cm.	GN
42452-53	53x32,5x17	1/1

Chrome knob. – Pomolo cromato.



Bread basket
Cesta baguettes
Brotkorb
Corbeille à pain
Cesta pan

art.	cap. kg.	l. cm.
42461-35	35	20

With frame to fix the cover.
Con telaio per fissare il coperchio.



Roll-top cover
Coperchio roll-top
Rolltophaube
Couvercle roll-top
Campana roll-top

art.	cap. kg.
42452-35	35



SAN

Cover

Coperchio
Kuppelhaube
Couvercle
Campana

art. dim. cm. GN
41419-12 33x28x17 1/2

One front cut. – Con apertura frontale.



SAN

Cover

Coperchio
Kuppelhaube
Couvercle
Campana

art. dim. cm. GN
41418-11 54x33x20 1/1

One front cut. – Con apertura frontale.



SAN

Cover

Coperchio
Kuppelhaube
Couvercle
Campana

art. dim. cm. GN
41418-12 54x33x20 1/1

Totally closed. – Chiuso.



PP

Bread basket

Cesta baguettes
Brotkorb
Corbeille à pain
Cesta pan

art. dim. cm. col.
42991-25 25x19X6,5 ●
42991-32 32x23X7 ●



PP

Bread basket

Cesta baguettes
Brotkorb
Corbeille à pain
Cesta pan

art. dim. cm. col.
42991M25 25x19X6,5 ●
42991M32 32x23X7 ●



PP

Bread basket

Cesta baguettes
Brotkorb
Corbeille à pain
Cesta pan

art. dim. cm. col.
42991N25 25x19X6,5 ●
42991N32 32x23X7 ●



PP

Bread basket

Cesta baguettes
Brotkorb
Corbeille à pain
Cesta pan

art. dim. cm. col.
42993-40 40X30X10 ●
42993M40 40X30X10 ●
42993N40 40X30X10 ●



PP

Bread basket

Cesta baguettes
Brotkorb
Corbeille à pain
Cesta pan

art. cap. kg. l. cm. col.
42990-16 16 8 ●
42990-20 20 8 ●
42990-29 29 7 ●



PP

Bread basket

Cesta baguettes
Brotkorb
Corbeille à pain
Cesta pan

art. cap. kg. l. cm. col.
42990M16 16 8 ●
42990M20 20 8 ●
42990M29 29 7 ●



PP

Bread basket

Cesta baguettes
Brotkorb
Corbeille à pain
Cesta pan

art. cap. kg. l. cm. col.
42990N16 16 8 ●
42990N20 20 8 ●
42990N29 29 7 ●



W

Bread basket stand

Alzata ceste
Körbe-Gestell
Etagère à corbeilles
Soporte ceste pan

art. dim. cm.
42870-59 30,5x59x58

**For baskets 42968-38 and 42967-13.
Per cesti 42968-38 e 42967-13.**



Frame, chrome plated, 2 tiers

Supporto cromato, 2 piani
Brotkorb-Gestell, Doppeldecker
Support chomé, 2 étages
Estructura cromada, 2 alturas

art. dim. cm. GN
42965-AB 29x27x35 1/2
42965-AA 50x34x37,5 1/1



Frame, chrome plated, 2 tiers
Supporto cromato, 2 piani
Brotkorb-Gestell, Doppeldecker
Support chomé, 2 étages
Estructura cromada, 2 alturas

art.	dim. cm.
42872-02	46x24x21

For baskets/Per cesti:
42965-12, 42967- 04-14-64-74.



Round canvas bag
Cesto cotone, rotondo
Brottasche, rund, Baumwolle
Panier à pain, coton
Cesta pan, algodón

art.	cap. kg.	l. cm.	col.
42873-02	20	23,5	●

Cherry stone pillow included. Easy to heat up in microwave for 90 sec. at 500 Watt. – Cuscino in noccioli di ciliegio incluso. Scaldare in microonde per 90 secondi a 500 Watt.



Egg basket, keeps warm
Cesto uova, imbottito
Eier-Korb, hält warm
Panier à oeufs, fourré
Cesta para huevos

art.	cap. kg.	l. cm.
42949-26	26	17

For around 20 eggs. – Per c.ca 20 uova.



Bread box
Cesta pane
Brotkiste
Caisse à pain
Cajón para pan

art.	dim. cm.
42874-01	34x26x12,5
42874-02	34x26x20

Beech wood. – Faggio.



Bread cutting board
Tagliere
Brottschneidbrett
Planche à découper
Tabla de corte

art.	dim. cm.
42874-03	52x34x2

Beech wood. – Faggio.



Cutting board tray
Vassoio per tagliere
Schneidbrett-Tablett
Plateau pour planche à découper
Bandeja para tabla de corte

art.	dim. cm.
42874-04	60x35,5x3,5



Sign holders, chromed, set 2pcs

Clip flessibili, cromate, set 2 pz
Schildelhalter, verchromt, 2er Set
Porte-étiquettes, chromés, 2 pcs
Porta etichetas con clip, cromate, 2 pz

art.	l. cm.	lt.
41394-02	12	2



Chalkmarker

Penna a gesso liquido
Kreidestifte
Stylo à craie liquide
Rotulador de tiza líquida

art.	Ø mm.	col.
47832-00	5	○
47832-01	5	●
47832-02	5	●
47832-03	5	●
47832-04	5	●
47832-05	5	●

Clean with water. Writes on all non porous surfaces. – Pulire con acqua. Scrive su tutte le superfici non porose.



Chalkmarker

Penna a gesso liquido
Kreidestifte
Stylo à craie liquide
Rotulador de tiza líquida

art.	Ø mm.	col.
47832-10	15	○
47832-11	15	●
47832-12	15	●
47832-13	15	●
47832-14	15	●
47832-15	15	●



W
SAN
SS

Showplate, 3-pcs set

Vetrina, set 3 pezzi
Buffetvitrine, 3-teilig
Etagère, set 3 pièces
Vitrina, 3 elementos

art.	Ø cm.	h. cm.
41429-04	45	24



SAN

Roll-top cover

Coperchio roll-top
Rolltophaube
Couverture roll-top
Campana roll-top

art.	Ø cm.	h. cm.
41447-38	38	20

Chrome knob. – Pomolo cromato.



SAN
SS

Showplate, 2-pcs set

Vetrina, set 2 pezzi
Buffetvitrine, 2-teilig
Etagère, set 2 pièces
Vitrina, 2 elementos

art.	Ø cm.	h. cm.
41447-02	38	21



❄️
SAN
SS

Showplate, 5-pcs set

Vetrina, set 5 pezzi
Buffetvitrine, 5-teilig
Etagère, set 5 pièces
Vitrina, 5 elementos

art.	Ø cm.	h. cm.
41447-05	38	24



❄️
W
SAN
SS

Showplate, 3-pcs set

Vetrina, set 3 pezzi
Buffetvitrine, 3-teilig
Etagère, set 3 pièces
Vitrina, 3 elementos

art.	Ø cm.	h. cm.
41905-38	43	4,5

Roll-top 41447-38 not included. Coperchio 41447-38 non incl.



AY
SS

Buffet showcase, 2 tiers

Vetrina 2 piani
Büffet-Vitrine, Doppeldecker
Vitrine 2 étages
Vitrina doble

art.	Ø cm.	h. cm.
41905-03	43,5	50

Roll-top 41447-38 not included.
Coperchio 41447-38 non incl.



SAN
SS

Showplate, 3-pcs set

Vetrina, set 3 pezzi
Buffetvitrine, 3-teilig
Etagère, set 3 pièces
Vitrina, 3 elementos

art.	Ø cm.	h. cm.	col.
41944-06	38	6	○
41944B06	38	6	●



SAN

Roll-top cover

Coperchio roll-top
Rolltophaube
Couvercle roll-top
Campana roll-top

art.	Ø cm.	h. cm.
41945-38	38	20



AY
SS

Buffet showcase, 2 tiers

Vetrina 2 piani
Büffet-Vitrine, Doppeldecker
Vitrine 2 étages
Vitrina doble

art.	dim. cm.
41428-03	61x38x52

Roll-top lids 41415-11 not included.
Coperchi 41415-11 non incl.



PC

Roll-top cover

Coperchio roll-top
Rolltophaube
Couvercle roll-top
Campana roll-top

art.	dim. cm.	GN
41415-10	53x32,5x17	1/1

Gold plated knob. – Barretta dorata.



PC

Roll-top cover

Coperchio roll-top
Rolltophaube
Couvercle roll-top
Campana roll-top

art.	dim. cm.	GN
41415-11	53x32,5x17	1/1

Chrome knob. – Pomolo cromato.



SS

Showplate, 4-pcs set

Vetrina, set 4 pezzi
Buffetvitrine, 4-teilig
Etagère, set 4 pièces
Vitrina, 4 elementos

art.	dim. cm.	GN
41907-56	56,5x36x8,5	1/1

Box + tray GN 1/1 + 2 cooler, without rolltop cover 41415-11. – Base + vassoio + 2 eutettici, coperchio 41415-11 non incl.



W

Showplate, 4-pcs set

Vetrina, set 4 pezzi
Buffetvitrine, 4-teilig
Etagère, set 4 pièces
Vitrina, 4 elementos

art.	dim. cm.
41906-60	60x41x5

Box + tray GN 1/1 + 2 cooler, without rolltop cover 41415-11. – Base + vassoio + 2 eutettici, coperchio 41415-11 non incl.



SS

Showplate, 4-pcs set

Vetrina, set 4 pezzi
Buffetvitrine, 4-teilig
Etagère, set 4 pièces
Vitrina, 4 elementos

art.	dim. cm.	col.
41940-06	43,5x32,5x6	○
41940B06	43,5x32,5x6	●

Box, tray, 2 coolers.
Contenitore, vassoio, 2 eutettici.



SAN

Roll-top cover

Coperchio roll-top
Rolltophaube
Couvercle roll-top
Campana roll-top

art.	dim. cm.
41941-44	44X33,5x17



W

Cutting board

Tagliere
Schneidebrett
Planche à découper
Tabla de corte

art.	dim. cm.
41941-43	43,5X32,5x2



AY

PC

SS

Cool bowl

Ciotola refrigerata
Kühlschale
Bol réfrigérée
Bol refrigerda

art.	Ø cm.	h. cm.	lt.
41448-06	14	9,0	0,6
41448-10	14	11,5	1,0

Base + cooler + bowl + cover.
Base + eutettico + ciotola + coperchio.



AY

PC

SS

Cool bowl

Ciotola refrigerata
Kühlschale
Bol réfrigérée
Bol refrigerda

art.	Ø cm.	h. cm.	lt.
41448-25	22	14	2,5
41448-40	22	18	4,0

Base + cooler + bowl + cover.
Base + eutettico + ciotola + coperchio.



Buffet stand, chrome plated

Alzata, cromata
Buffet-Gestell, Metall hartverchromt
Présentoir, chromé
Soporte, cromado

art.	Ø cm.	h. cm.
41442-01	24	17

Glass bowl ø cm 23 + cover.
Ciotola ø cm 23 + coperchio.



Buffet stand, chrome plated

Alzata, cromata
Buffet-Gestell, Metall hartverchromt
Présentoir, chromé
Soporte, cromado

art.	dim. cm.
41442-03	61x24x35

3 glass bowls ø cm 23 + 3 covers.
3 ciotole ø cm 23 + covers.



Buffet stand, chrome plated

Alzata, cromata
Buffet-Gestell, Metall hartverchromt
Présentoir, chromé
Soporte, cromado

art.	dim. cm.
41442-14	30x30x14

3 glass bowls ø cm 14 + 3 covers.
3 ciotole ø cm 14 + covers.



Buffet stand, chrome plated

Alzata, cromata
Buffet-Gestell, Metall hartverchromt
Présentoir, chromé
Soporte, cromado

art.	dim. cm.
41442-23	50x50x18

3 glass bowls ø cm 23 + 3 covers.
3 ciotole ø cm 23 + covers.



Bowl holder, chromed

Portaciotole, cromato
Schalenhalter, Metall hartverchromt
Etagère à bols, chromée
Soporte para bols, cromado

art.	Ø cm.	h. cm.
41427-40	18	25,5

For 36 bowls ø cm 7 # 41425-AA.
Per 36 ciotoline ø cm 7 # 41425-AA.

**BUFFET
DISPLAY & PRESENTATION**



Serving stand, chrome plated

Alzata, cromata
Serviergestell, Metall hartverchromt
Présentoir, chromé
Soporte platos para buffet, cromado

art. Ø cm. h. cm.
42962-04 34 37

For 4 plates max. Ø 31 cm, inside Ø 23,5 cm.



Serving stand, chrome plated

Alzata, cromata
Serviergestell, Metall hartverchromt
Présentoir, chromé
Soporte platos, cromado

art.	dim. cm.	col.
42962C26	18,5x15,5x26	●
42962C44	29x19,5x43	●

26: for 3 plates max. Ø 17 cm, inside Ø 10,5 cm

44: for 3 plates max. Ø 27 cm, inside Ø 18 cm



Serving stand

Alzata
Serviergestell
Présentoir
Soporte platos

art.	dim. cm.
42962-26	18,5x15,5x26
42962-30	29x19,5x30
42962-44	29x19,5x43

26: for 3 plates max. Ø 17 cm, inside Ø 10,5 cm

30: for 2 plates max. Ø 27 cm, inside Ø 18 cm

44: for 3 plates max. Ø 27 cm, inside Ø 18 cm



SAN
AY

Multi rack

Multi-distributore
Multi Rack
Distributeur
Dispensador

art. dim. cm.
41908-01 26x18x43



SAN
W

Multi rack

Multi-distributore
Multi Rack
Distributeur
Dispensador

art. dim. cm.
41908-00 26x18x43



SAN
SS

Multi rack

Multi-distributore
Multi Rack
Distributeur
Dispensador

art. dim. cm.
41911-02 19x24x28



SAN
SS

Multi rack

Multi-distributore
Multi Rack
Distributeur
Dispensador

art. dim. cm.
41911-03 19x24x41



SAN
SS

Multi rack

Multi-distributore
Multi Rack
Distributeur
Dispensador

art. dim. cm.
41911-04 19x24x53





Buffet ladder, chrome plated

Espositore buffet, cromato
Büffet-Leiter, verchromt
Escalier à buffet, chromé
Escalera para buffet, cromada

art. dim. cm.
41912-03 30x30x48

With 4 bowls ø cm 14 + lids.
Con 4 ciotole ø cm 14 + coperchi.



Buffet ladder, chrome plated

Espositore buffet, cromato
Büffet-Leiter, verchromt
Escalier à buffet, chromé
Escalera para buffet, cromada

art. dim. cm.
41912-04 30x30x48

With 6 bowls ø cm 14. – Con 6 ciotole ø cm 14.



Buffet ladder, chrome plated

Espositore buffet, cromato
Büffet-Leiter, verchromt
Escalier à buffet, chromé
Escalera para buffet, cromada

art. dim. cm.
41913-03 39x31x66

With 4 bowls ø cm 23 + lids.
Con 4 ciotole ø cm 23 + coperchi.



Buffet ladder, chrome plated

Espositore buffet, cromato
Büffet-Leiter, verchromt
Escalier à buffet, chromé
Escalera para buffet, cromada

art. dim. cm.
41913-04 39x31x66

With 6 bowls ø cm 23. – Con 6 ciotole ø cm 23.



Buffet ladder, chrome plated

Espositore buffet, cromato
Büffet-Leiter, verchromt
Escalier à buffet, chromé
Escalera para buffet, cromada

art. dim. cm. GN
41403-01 31,5x32x48 1/3



Buffet ladder, chrome plated

Espositore buffet, cromato
Büffet-Leiter, verchromt
Escalier à buffet, chromé
Escalera para buffet, cromada

art. dim. cm. GN
41403-02 31,5x41,5x48 1/2



Buffet ladder, chrome plated

Espositore buffet, cromato
Büffet-Leiter, verchromt
Escalier à buffet, chromé
Escalera para buffet, cromada

art. dim. cm. GN
41403-03 31,5x56x66 1/2





GN

Buffet ladder, chrome plated

Espositore buffet, cromato
Büffet-Leiter, verchromt
Escalier à buffet, chromé
Escalera para buffet, cromada

art. dim. cm. GN
41403-04 52x59x66 1/1



PMMA

Cereal-bar

Espositore per cereali
Cerealien-Bar
Présentoir à céréales
Expositor de cereales

art. dim. cm. lt.
41918-01 26x15x5x4 2x1,5
41918-02 26x15x5x8 2x1,5



PMMA

Cereal-bar

Espositore per cereali
Cerealien-Bar
Présentoir à céréales
Expositor de cereales

art. dim. cm. lt.
41918-03 38x15,5x4 3x1,5
41918-04 38x15,5x8 3x1,5



SAN

SS

Cereal pitcher

Caraffa cereali
Cerealienkaraffe
Pichet à céréales
Jarra de cereales

art. lt.
41918-05 1,5

Stainless steel flap lid + 1 airtight cover.
Coperchio inox incernierato + 1 coperchio ermetico.



PC

SS

Cereal dispenser

Distributore di cereali
Müslispender
Distributeur à céréales
Dispensador de cereales

art. Ø cm. h. cm. lt.
41909-13 38 54 3x4,5



PC

SS

Cereal dispenser

Distributore di cereali
Müslispender
Distributeur à céréales
Dispensador de cereales

art. dim. cm. lt.
41909-08 35x26,5x68 8



SAN

SS

Cereal dispenser

Distributore di cereali
Müslispender
Distributeur à céréales
Dispensador de cereales

art. dim. cm. lt.
41810-04 22x17,5x52 4,5



SAN
SS

Cereal dispenser

Distributore di cereali
Müslispender
Distributeur à céréales
Dispensador de cereales

art.	dim. cm.	lt.
41810-09	22x35x52	2x4,5



SS
❄️

Juice dispenser

Distributore di succhi
Saftdispenser
Distributeur à jus
Dispensador zumos

art.	dim. cm.	lt.
58353-17	22x35x56	7



SS
❄️

Juice dispenser

Distributore di succhi
Saftdispenser
Distributeur à jus
Dispensador zumos

art.	dim. cm.	lt.
41902-04	21x32x43	4



SS
❄️

Juice dispenser

Distributore di succhi
Saftdispenser
Distributeur à jus
Dispensador zumos

art.	dim. cm.	lt.
41902-06	23x35x52	6



W
SS
❄️

Juice dispenser

Distributore di succhi
Saftdispenser
Distributeur à jus
Dispensador zumos

art.	dim. cm.	lt.
41907-04	21x31x44	4

Beechwood. – Faggio.



W
SS
❄️

Juice dispenser

Distributore di succhi
Saftdispenser
Distributeur à jus
Dispensador zumos

art.	dim. cm.	lt.
41907-06	23x35x52	6

Beechwood. – Faggio.



SS
❄️

DUO juice dispenser

Distributore di succhi DUO
Saftdispenser DUO
Distributeur à jus DUO
Dispensador de zumo, doble

art.	dim. cm.	lt.
41917-02	42x35x52	2x6



W
SS
❄️

DUO juice dispenser

Distributore di succhi DUO
Saftdispenser DUO
Distributeur à jus DUO
Dispensador de zumo, doble

art.	dim. cm.	lt.
41907-02	42x35x52	2x6

Beechwood. – Faggio.



SS
❄️

Juice dispenser

Distributore di succhi
Saftdispenser
Distributeur à jus
Dispensador zumos

art.	dim. cm.	lt.
41901-08	36x26x55	8



DUO juice dispenser

Distributore di succhi DUO
Saftdispenser DUO
Distributeur à jus DUO
Dispensador de zumo, doble

art.	dim. cm.	lt.
41901-16	36x52x55	2x8



Milk dispenser

Distributore di latte
Milchkanne
Distributeur à lait
Dispensador de leche

art.	dim. cm.	lt.
41910-03	21x32x39	3



Milk dispenser

Distributore di latte
Milchkanne
Distributeur à lait
Dispensador de leche

art.	dim. cm.	lt.
41910-05	23x35x52	5



Milk dispenser

Distributore di latte
Milchkanne
Distributeur à lait
Dispensador de leche

art.	dim. cm.	lt.
41920-03	21x32x39	3

Beechwood. – Faggio.



Milk dispenser

Distributore di latte
Milchkanne
Distributeur à lait
Dispensador de leche

art.	dim. cm.	lt.
41920-05	23x35x52	5

Beechwood. – Faggio.



Milk dispenser

Distributore di latte
Milchkanne
Distributeur à lait
Dispensador de leche

art.	dim. cm.	lt.
41900-04	23x32x42	4

Beechwood. – Faggio.



Milk dispenser

Distributore di latte
Milchkanne
Distributeur à lait
Dispensador de leche

art.	dim. cm.	lt.
41900-10	27x38,5x45	10

Beechwood. – Faggio.



Insulated dispenser

Distributore termico
Iso-Dispenser
Distributeur isothermique
Dispensador térmico

art.	Ø cm.	h. cm.	lt.
41904-10	24	42	9,5



Air pot

Caraffa termica
Thermopumpkanne
Pot à air isothermique
Jarra térmica

art.	lt.
42406-35	3,5
42406-40	4,0



SS

Air pot
Caraffa termica
Thermopumpkanne
Pot à air isothermique
Jarra térmica

art.	lt.
42400-19	1,9
42400-25	2,5
42400-30	3,0



FE

SS

Fruit stand
Espositore porta frutta
Obstspender
Etagère à fruits
Expositor frutas

art.	cap. kg.	h. cm.
41449-27	27,5	32



FE

SS

Fruit stand
Espositore porta frutta
Obstspender
Etagère à fruits
Expositor frutas

art.	cap. kg.	h. cm.
41449-32	32	53



SS

Fruit stand, 3 tiers
Alzata frutta, 3 piani
Obständer, 3-stöckig
Etagère à fruits, 3 étages
Frutero 3 pisos

art.	Ø cm.	h. cm.
42940-03	32-38-48	50



SS

Fruit stand
Alzata Royale
Obständer
Etagère Royale
Expositor de frutas

art.	Ø cm.	h. cm.
41820-03	24-33-42	50



Wedding cake stand, aluminum
Alzata per torte, alluminio
Hochzeitstortenständer, Aluminium
Support pour tourte de mariage, alu
Pedestal para tartas, aluminio

art.	Ø cm.
47100-03	20-26-32
47100-04	20-26-32-40
47100-05	20-26-32-40-45

Distance between tiers 16,5 cm.
Distanziali h. 16,5 cm.



Wedding cake stand, aluminum
Alzata per torte, alluminio
Hochzeitstortenständer, Aluminium
Support pour tourte de mariage, alu
Pedestal para tartas, aluminio

art.	Ø cm.
47100-06	20-26-32-40-45-50
47100-07	16-20-26-32-40-45-50
47100-08	16-20-26-32-40-45-50-55

Distance between tiers 16,5 cm.
Distanziali h. 16,5 cm.



PC

Punch bowl
Coppa punch
Punchbowl
Rafraîchisseur
Ponchero

art.	Ø cm.	lt.
41541-44	44	15

Stainless steel bottom ring. – Piede inox.



SS

Punch bowl
Coppa punch
Punchbowl
Rafraîchisseur
Ponchero

art.	Ø cm.	lt.
11956-37	36	9,5
11956-42	42	15,0



AY

Big party tub
Secchio portabottiglie
Flaschenkühler-Bowle
Rafraîchisseur à bouteilles
Ponchero

art. dim. cm.
44946-04 40x28x23



AY

Big party tub
Secchio portabottiglie
Flaschenkühler-Bowle
Rafraîchisseur à bouteilles
Ponchero

art. dim. cm.
44946-05 35x35x20



AY

Big party tub
Secchio portabottiglie
Flaschenkühler-Bowle
Rafraîchisseur à bouteilles
Ponchero

art. dim. cm.
44946B05 35x35x20



SS

Lighting column
Colonna luminosa
Lichtsäule
Socle lumineux
Columna luminosa

art. Ø cm. h. cm.
42979-00 30 21

Stainless steel base plate ø30 cm., PMMA column, LED-light box and remote control.

Base inox ø cm 30, colonna PMMA, scatola luci-LED con telecomando.



SS

Oyster plate
Piatto frutti di mare
Austernplatte
Plat à huîtres
Fuente de mariscos

art. Ø cm. h. cm.
42979-36 36 4,5

The plate has a centering element which keeps it anchored to the column.



SS

Oyster plate
Piatto frutti di mare
Austernplatte
Plat à huîtres
Fuente de mariscos

art. Ø cm. h. cm.
42979-45 45 5,5

Sotto il piatto è fissato un elemento di centraggio che lo mantiene ancorato alla colonna luminosa.



SS

Cocktail fountain
Fontana cocktails
Cocktails-Laufbrunnen
Fontaine à cocktails
Fuente cocktail

art. Ø cm. h. cm. lt.
42981-73 42 56 15

10W 220V. NOT recommend for use with fizzy drinks or champagne. – Prodotto NON consigliato per liquidi gasati o champagne.



SS

Champagne Waterfall
Cascata champagne
Sekt Wasserfall
Cascade à champagne
Cascada champañã

art. Ø cm. h. cm.
42980-01 45 64

LED lighting multicolor cycle. For 42 champagne cups. – Illuminazione led a ciclo multicolore. Per 42 coppe champagne.



SS

Champagne Waterfall
Cascata champagne
Sekt Wasserfall
Cascade à champagne
Cascada champañã

art. Ø cm. h. cm.
42980-02 45 107

LED lighting multicolor cycle. For 73 champagne cups. – Illuminazione led a ciclo multicolore. Per 73 coppe champagne.

ATLANTIC BUFFET SYSTEM

BUFFET & PRESENTATION



Conceived and designed in the round and rectangular versions with different opening systems to meet any need ABS Atlantic Buffet System chafing dishes combine contemporary flexibility and functionality. All the parts of these simple-shaped, stackable, 100% stainless steel hygienic items can be easily taken apart for thorough cleaning.

The line comes from the expertise that only Sambonet Paderno can offer to top catering services. The lid is equipped with a new, transparent window made of unbreakable glass that lets you see the delicacies held in the chafing dishes. The gradual closing mechanism and the special lid removal method make the whole System even more effective.

Pensati e ideati nelle versioni rotonde, rettangolari con aperture differenziate per soddisfare ogni esigenza, gli scaldavivande ABS Atlantic Buffet System interpretano la funzionalità e la flessibilità contemporanea. Semplici nella forma, impilabili, igienici poiché realizzati in acciaio inox, facilmente smontabili in tutte le loro parti per una pulizia impeccabile, gli elementi appartenenti alla linea nascono dall'expertise che solo Sambonet Paderno è in grado di garantire alla ristorazione d'eccellenza. Grazie alla trasparenza del nuovo oblò in vetro temperato, i coperchi offrono visibilità alla prelibatezza dei contenuti degli scaldavivande. Il meccanismo di chiusura graduale e lo speciale metodo di rimozione dei coperchi rende ancora più performante l'intero Sistema.



TOP UNIT - Chafing dish round

Scaldavivande tondo
Chafing Dish, rund
Chafing dish rond
Chafing dish redondo

art.	Ø cm.	h. cm.	lt.
58176-30	30	15	2,8
58176-36	36	15	5,0
58176-40	40	17	7,8



TOP UNIT - Chafing dish round

Scaldavivande tondo
Chafing Dish, rund
Chafing dish rond
Chafing dish redondo

art.	Ø cm.	h. cm.	lt.
58166-24	24	15	2,0
58166-30	30	15	2,8
58166-36	36	15	5,0
58166-40	40	17	7,8



Round stand

Supporto rotondo
Gestell, rund
Support rond
Soporte redondo

art.	Ø cm.
58166-AA	24
58166-AM	30
58166-AB	36
58166-AC	40



TOP UNIT - Chafing dish rectangular

Scaldavivande rettangolare
Chafing Dish, rechteckig
Chafing dish rectangulaire
Chafing dish rectangular

art.	dim. cm.	lt.
58172-54	57x47x18	10

Long side opening. – Apertura lato lungo.



art.	dim. cm.	lt.
58172-56	68,5x35,5x18	10

Short side opening. – Apertura lato corto.



TOP UNIT - Chafing dish rectangular

Scaldavivande rettangolare
Chafing Dish, rechteckig
Chafing dish rectangulaire
Chafing dish rectangular

art.	dim. cm.	lt.
58162-54	57x47x18	10

Long side opening. – Apertura lato lungo.



art.	dim. cm.	lt.
58162-56	68,5x35,5x18	10

Short side opening. – Apertura lato corto.



Rectangular stand
Supporto rettangolare
Gestell, rechteckig
Support rectangulaire
Soporte rectangular

art. dim. cm.
58162-AA 57x47

ATLANTIC BUFFET SYSTEM INDUCTION HOBS



ABS-Atlantic Buffet System chafing dishes can be used on any heat source, gas, electric, glass-ceramic and induction*. We recommend our free-standing (58162-RA) and built-in (58162-RB) cookers.

As a matter of fact, these induction cookers are ideal for any buffet where food should be kept at a specific temperature to preserve flavours.

***NOT SUITABLE for induction hobs with frequency identification.**

Gli scaldavivande ABS-Atlantic Buffet System sono ideati per ogni tipo di cottura, gas, elettrica, vetroceramica e induzione* per la quale si raccomanda l'utilizzo delle piastre proposte dall'azienda, disponibili sia nella versione da appoggio art. 58162-RA sia da incasso art. 58162-RB. Questi piani ad induzione sono infatti l'ideale per tutti i buffet ove indispensabile mantenere i cibi ad una temperatura ottimale per la conservazione dei sapori.

*NON UTILIZZABILI su piani ad induzione con riconoscimento di frequenza.



Induction cooker, to be built into counter

Piastra ad induzione, da incasso
Induktionsplatte, thekeneinbau
Plaque à induction, montage au comptoir
Placa a inducción para emportar

art. dim. cm.
58162-RB 36X38x12,5

Schott ceran hob, timer (0-180 min.), 1-10 power levels, temperature range 60°C-240°C.

Piano in vetroceramica Schott, timer 0-180 minuti, 1-10 livelli di potenza, temperatura 60-240°C.



Induction cooker
Piastra ad induzione
Induktionsplatte
Plaque à induction
Placa a inducción

art. dim. cm.
58162-RA 30X37x10

Stainless steel body, Schott ceran hob, led display, timer (0-180 min.), 1-10 power levels, temperature range 60°C-240°C.

Corpo inox, piano in vetroceramica Schott, display a led, timer 0-180 minuti, 1-10 livelli di potenza, temperatura 60-240°C.



TOP UNIT - Chafing dish round

Scaldavivande tondo
Chafing Dish, rund
Chafing dish rond
Chafing dish redondo



art.	Ø cm.	h. cm.	lt.
58166I30	30	15	2,8
58166I36	36	15	5,0
58166I40	40	17	7,8



TOP UNIT - Chafing dish round

Scaldavivande tondo
Chafing Dish, rund
Chafing dish rond
Chafing dish redondo



art.	Ø cm.	h. cm.	lt.
58176I30	30	15	2,8
58176I36	36	15	5,0
58176I40	40	17	7,8



BUILT-IN UNIT - Chafing dish rectangular

Scaldavivande rettangolare
Chafing Dish, rechteckig
Chafing dish rectangulaire
Chafing dish rectangular

art.	dim. cm.	lt.	std	V-W
58162A55	57x47x18	10		
58162E55	57x47x18	10	EU	250-360
58162U55	57x47x18	10	US	120-450

Long side opening. – Apertura lato lungo.



art.	dim. cm.	lt.	std	V-W
58162A57	68,5x35,5x18	10		
58162E57	68,5x35,5x18	10	EU	250-360
58162U57	68,5x35,5x18	10	US	120-450

Short side opening. – Apertura lato corto.



art.	dim. cm.	lt.	std	V-W
58172A55	57x47x18	10		
58172E55	57x47x18	10	EU	250-360
58172U55	57x47x18	10	US	120-450

Long side opening. – Apertura lato lungo.



art.	dim. cm.	lt.	std	V-W
58172A57	68,5x35,5x18	10		
58172E57	68,5x35,5x18	10	EU	250-360
58172U57	68,5x35,5x18	10	US	120-450

Short side opening. – Apertura lato corto.



Electric heating units

Piastre elettriche
Elektro-Heizelemente
Corps de chauffe électriques
Calentadores eléctricos

art.	dim. cm.	std	V-W
58162-KE	20x25	EU	220-380
58162-KU	20x25	US	110-450

For rectangular ABS. – Per ABS rettangolari.



art.	Ø cm.	std	V-W
58341-KE	13,5	EU	220-80
58341-KU	13,5	US	110-170

For ø cm 24 round ABS. – Per ABS tondo ø cm 24.



art.	dim. cm.	std	V-W
58166-KP	20x21	EU	220-180

For ø cm 30 round ABS. – Per ABS tondo ø cm 30.



art.	dim. cm.	std	V-W
58166-KE	20x25	EU	220-200
58166-KU	20x25	US	110-240

For ø cm 36-40 round ABS. – Per ABS tondo ø cm 36-40.



Thermoregulator
Termoregolare
Thermoregler
Thermorégulateur
Termorregulador

art.	std
58132-AE	EU



art.	std
58132-AU	US

For rectangular and round ø cm 36-40 ABS – Per ABS rettangolari e tondi ø cm 36-40.



Fuel Holder, stainless steel
Portacombustibile, inox
Brennstoffhalterung, Edelstahl Rostfrei
Porte Brûleur, inox
Contenedor de combustible, inox

art.
58136-KA

Kit for ABS ø cm 24-30-36 – Set per ABS ø cm 24-30-36



art.
58132-KA

Kit for ABS rectangular and ø cm 40 – Set per ABS rettangolari e ø cm 40



Round porcelain insert
Inserto tondo, porcellana
Porzellaneinsatz, rund
Bac rond, porcelaine
Baño-maria redondo, porcelana

art.	Ø cm.
58166-EL	30
58166-EC	36
58166-EB	40



Round porcelain insert, 2 food sections
 Inserto tondo, porcellana, 2 scomparti
 Porzellaneinsatz 2-tlg., rund
 Bac rond, porcelaine, 2 compartements
 Baño-maria redondo, porcelana 2 compartimentos

art.	Ø cm.
58166-ED	36
58166-EJ	40



Round food pan, stainless steel
 Portavivande tondo, inox
 Einsatzbehälter, rund, Edelstahl Rostfrei
 Bac rond, inox
 Baño-maria redondo, inox

art.	Ø cm.
58166-EG	24
58166-EM	30
58166-EH	36
58166-EI	40



Chafing dish round, solid alcohol heating
 Scaldavivande tondo a combustibile solido
 Chafing Dish, rund mit Brennstoff beheizt
 Chafing dish rond, chauffage au combustible solide
 Chafing dish redondo, calefacción con combustible sólido

art.	Ø cm.	h. cm.	lt.
58166A24	24	27	2,0
58166A30	30	27	2,8
58166A36	36	27	5,0
58166A40	40	28	7,8



Chafing dish round, electric heating
 Scaldavivande tondo, riscaldamento elettrico
 Chafing Dish, rund, elektrisch beheizt
 Chafing dish rond, chauffage électrique
 Chafing dish redondo, calefacción eléctrica

art.	Ø cm.	h. cm.	lt.	std	V-W
58166E24	24	27	2,0	EU	250-80
58166E30	30	27	2,8	EU	250-190
58166E36	36	27	5,0	EU	250-190
58166E40	40	28	7,8	EU	250-190
58166U24	24	27	2,0	US	120-170
58166U36	36	27	5,0	US	120-240
58166U40	40	28	7,8	US	120-240



Chafing dish round, solid alcohol heating
 Scaldavivande tondo a combustibile solido
 Chafing Dish, rund mit Brennstoff beheizt
 Chafing dish rond, chauffage au combustible solide
 Chafing dish redondo, calefacción con combustible sólido

art.	Ø cm.	h. cm.	lt.
58176A30	30	27	2,8
58176A36	36	27	5,0
58176A40	40	28	7,8



Chafing dish round, electric heating
 Scaldavivande tondo, riscaldamento elettrico
 Chafing Dish, rund, elektrisch beheizt
 Chafing dish rond, chauffage électrique
 Chafing dish redondo, calefacción eléctrica

art.	Ø cm.	h. cm.	lt.	std	V-W
58176E30	30	27	2,8	EU	250-190
58176E36	36	27	5,0	EU	250-190
58176E40	40	28	7,8	EU	250-190
58176U36	36	27	5,0	US	120-240
58176U40	40	28	7,8	US	120-240



Petite marmite, solid alcohol heating
Petite marmite a combustibile solido
Petite Marmite, mit Brennstoff beheizt
Petite marmite, chauffage au combustible solide
Petite marmite, calefacción con combustible sólido

art.	Ø cm.	h. cm.	lt.
58168A24	24	35	7



Petite marmite, electric heating
Petite marmite, riscaldamento elettrico
Petite Marmite, elektrisch beheizt
Petite marmite, chauffage électrique
Petite marmite, calefacción eléctrica

art.	Ø cm.	h. cm.	lt.	std	V-W
58168E24	24	35	7	EU	250-80
58168U24	24	35	7	US	120-170



Soup tureen without lid
Zuppiera senza coperchio
Suppenschüssel ohne Deckel
Soupière sans couvercle
Sopera sin tapa

art.	Ø cm.	lt.
58168-GA	24	7



Chafing dish rectangular, solid alcohol heating
Scaldavivande rettangolare a combustibile solido
Chafing Dish, rechteckig mit Brennstoff beheizt
Chafing dish rectangulaire, chauffage au combustible solide
Chafing dish rectangular, calefacción con combustible sólido

art.	dim. cm.	lt.
58162A54	57x47x30,5	10



Chafing dish rectangular, electric heating
Scaldavivande rettangolare, riscaldamento elettrico
Chafing Dish, rechteckig, elektrisch beheizt
Chafing dish rectangulaire, chauffage électrique
Chafing dish rectangular, calefacción eléctrica

art.	dim. cm.	lt.	std	V-W
58162E54	57x47x30,5	10	EU	250-360
58162U54	57x47x30,5	10	US	120-450



Chafing dish rectangular, solid alcohol heating
Scaldavivande rettangolare a combustibile solido
Chafing Dish, rechteckig mit Brennstoff beheizt
Chafing dish rectangulaire, chauffage au combustible solide
Chafing dish rectangular, calefacción con combustible sólido

art.	dim. cm.	lt.
58162A56	68,5x35,5x30,5	10



Chafing dish rectangular, electric heating
 Scaldavivande rettangolare, riscaldamento elettrico
 Chafing Dish, rechteckig, elektrisch beheizt
 Chafing dish rectangulaire, chauffage électrique
 Chafing dish rectangular, calefacción eléctrica

art.	dim. cm.	lt.	std	V-W
58162E56	68,5x35,5x30,5	10	EU	250-360
58162U56	68,5x35,5x30,5	10	US	120-450



Chafing dish rectangular, solid alcohol heating
 Scaldavivande rettangolare a combustibile solido
 Chafing Dish, rechteckig mit Brennstoff beheizt
 Chafing dish rectangulaire, chauffage au combustible solide
 Chafing dish rectangular, calefacción con combustible sólido

art.	dim. cm.	lt.
58172A54	57x47x30,5	10



Chafing dish rectangular, electric heating
 Scaldavivande rettangolare, riscaldamento elettrico
 Chafing Dish, rechteckig, elektrisch beheizt
 Chafing dish rectangulaire, chauffage électrique
 Chafing dish rectangular, calefacción eléctrica

art.	dim. cm.	lt.	std	V-W
58172E54	57x47x30,5	10	EU	250-360
58172U54	57x47x30,5	10	US	120-450



Chafing dish rectangular, solid alcohol heating
 Scaldavivande rettangolare a combustibile solido
 Chafing Dish, rechteckig mit Brennstoff beheizt
 Chafing dish rectangulaire, chauffage au combustible solide
 Chafing dish rectangular, calefacción con combustible sólido

art.	dim. cm.	lt.
58172A56	68,5x35,5x30,5	10



Chafing dish rectangular, electric heating
 Scaldavivande rettangolare, riscaldamento elettrico
 Chafing Dish, rechteckig, elektrisch beheizt
 Chafing dish rectangulaire, chauffage électrique
 Chafing dish rectangular, calefacción eléctrica

art.	dim. cm.	lt.	std	V-W
58172E56	68,5x35,5x30,5	10	EU	250-360
58172U56	68,5x35,5x30,5	10	US	120-450

ASIA - ASIA 2000



Chafing dish rectangular, solid alcohol heating
 Scaldavivande rettangolare a combustibile solido
 Chafing Dish, rechteckig mit Brennstoff beheizt
 Chafing dish rectangulaire, chauffage au combustible solide
 Chafing dish rectangular, calefacción con combustible sólido

art.	dim. cm.	lt.
58132A54	67,5x44x42	10



Chafing dish rectangular, electric heating
 Scaldavivande rettangolare, riscaldamento elettrico
 Chafing Dish, rechteckig, elektrisch beheizt
 Chafing dish rectangulaire, chauffage électrique
 Chafing dish rectangular, calefacción eléctrica

art.	dim. cm.	lt.	std	V-W
58132E54	67,5x44x42	10	EU	250-360
58132U54	67,5x44x42	10	US	120-450



Chafing dish rectangular, solid alcohol heating
 Scaldavivande rettangolare a combustibile solido
 Chafing Dish, rechteckig mit Brennstoff beheizt
 Chafing dish rectangulaire, chauffage au combustible solide
 Chafing dish rectangular, calefacción con combustible sólido

art.	dim. cm.	lt.
58132A55	67,5x44x34,5	10



Chafing dish rectangular, electric heating
 Scaldavivande rettangolare, riscaldamento elettrico
 Chafing Dish, rechteckig, elektrisch beheizt
 Chafing dish rectangulaire, chauffage électrique
 Chafing dish rectangular, calefacción eléctrica

art.	dim. cm.	lt.	std	V-W
58132E55	67,5x44x34,5	10	EU	250-360
58132U55	67,5x44x34,5	10	US	120-450



Chafing dish round, solid alcohol heating
 Scaldavivande tondo a combustibile solido
 Chafing Dish, rund mit Brennstoff beheizt
 Chafing dish rond, chauffage au combustible solide
 Chafing dish redondo, calefacción con combustible sólido

art.	Ø cm.	h. cm.	lt.
58136A33	33	44	3,5
58136A40	40	58	6,0



Chafing dish round, electric heating
 Scaldavivande tondo, riscaldamento elettrico
 Chafing Dish, rund, elektrisch beheizt
 Chafing dish rond, chauffage électrique
 Chafing dish redondo, calefacción eléctrica

art.	Ø cm.	h. cm.	lt.	std	V-W
58136E33	33	44	3,5	EU	250-200
58136E40	40	58	6,0	EU	250-360
58136U33	33	44	3,5	US	120-240
58136U40	40	58	6,0	US	120-450



Chafing dish round, solid alcohol heating
 Scaldavivande tondo a combustibile solido
 Chafing Dish, rund mit Brennstoff beheizt
 Chafing dish rond, chauffage au combustible solide
 Chafing dish redondo, calefacción con combustible sólido

art.	Ø cm.	h. cm.	lt.
58136A34	33	34,5	3,5
58136A41	40	43,0	6,0



Chafing dish round, electric heating
 Scaldavivande tondo, riscaldamento elettrico
 Chafing Dish, rund, elektrisch beheizt
 Chafing dish rond, chauffage électrique
 Chafing dish redondo, calefacción eléctrica

art.	Ø cm.	h. cm.	lt.	std	V-W
58136E34	33	34,5	3,5	EU	250-200
58136E41	40	43,0	6,0	EU	250-360
58136U34	33	34,5	3,5	US	120-240
58136U41	40	43,0	6,0	US	120-450



Chafing dish rectangular, solid alcohol heating
 Scaldavivande rettangolare a combustibile solido
 Chafing Dish, rechteckig mit Brennstoff beheizt
 Chafing dish rectangulaire, chauffage au combustible solide
 Chafing dish rectangular, calefacción con combustible sólido

art.	dim. cm.	lt.
58152A54	67x49x44	10



Chafing dish rectangular, electric heating
 Scaldavivande rettangolare, riscaldamento elettrico
 Chafing Dish, rechteckig, elektrisch beheizt
 Chafing dish rectangulaire, chauffage électrique
 Chafing dish rectangular, calefacción eléctrica

art.	dim. cm.	lt.	std	V-W
58152E54	67x49x44	10	EU	250-360
58152U54	67x49x44	10	US	120-450

BUFFET & PRESENTATION



Chafing dish round, solid alcohol heating
Scaldavivande tondo a combustibile solido
Chafing Dish, rund mit Brennstoff beheizt
Chafing dish rond, chauffage au combustible solide
Chafing dish redondo, calefacción con combustible sólido

art.	Ø cm.	h. cm.	lt.
58156A33	33	47	3,5
58156A40	40	61	6,0



Chafing dish round, electric heating
Scaldavivande tondo, riscaldamento elettrico
Chafing Dish, rund, elektrisch beheizt
Chafing dish rond, chauffage électrique
Chafing dish redondo, calefacción eléctrica

art.	Ø cm.	h. cm.	lt.	std	V-W
58156E33	33	47	3,5	EU	250-200
58156E40	40	61	6,0	EU	250-360
58156U33	33	47	3,5	US	120-240
58156U40	40	61	6,0	US	120-450



Samovar, electric heating
Samovar, riscaldamento elettrico
Samovar, elektrisch beheizt
Samovar, chauffage électrique
Samovar, calefacción eléctrica

art.	h. cm.	lt.	Tea pot	std	V-W
58357E06	66	6	Lt 1	EU	230-1000
58357E09	74	9	Lt 1	EU	230-1000
58357E12	82	12	Lt 1,6	EU	230-1000
58357U06	66	6	Lt 1	US	115-1000
58357U09	74	9	Lt 1	US	115-1000
58357U12	82	12	Lt 1,6	US	115-1000



Coffee urn, electric heating
Scaldacaffè, riscaldamento elettrico
Kaffeedispenser, elektrisch beheizt
Réchaud à café, chauffage électrique
Calentador de café, calefacción eléctrica

art.	h. cm.	lt.	std	V-W
58355E06	50	6	EU	230-500
58355E09	57	9	EU	230-500
58355E12	65	12	EU	230-500
58355U06	50	6	US	115-500
58355U09	57	9	US	115-500
58355U12	65	12	US	115-500



Coffee urn, solid alcohol heating
Scaldacaffè, riscaldamento a combustibile solido
Kaffeedispenser mit Brennstoff beheizt
Réchaud à café, chauffage au combustible solide
Calentador de café, calefacción con combustible sólido

art.	h. cm.	lt.
58351A06	53	6
58351A09	59	9
58351A12	69	12
58351A18	85	18



Coffee urn, electric heating
Scaldacaffè, riscaldamento elettrico
Kaffeedispenser, elektrisch beheizt
Réchaud à café, chauffage électrique
Calentador de café, calefacción eléctrica

art.	h. cm.	lt.	std	V-W
58351E06	53	6	EU	220-80
58351E09	59	9	EU	220-80
58351E12	69	12	EU	220-80
58351E18	85	18	EU	220-80



art.	h. cm.	lt.	std	V-W
58351U06	53	6	US	110-170
58351U09	59	9	US	110-170
58351U12	69	12	US	110-170
58351U18	85	18	US	110-170



Chafing dish rectangular, solid alcohol heating

Scaldavivande rettangolare a combustibile solido
Chafing Dish, rechteckig mit Brennstoff beheizt
Chafing dish rectangulaire, chauffage au combustible solide
Chafing dish rectangular, calefacción con combustible sólido

art.	dim. cm.	lt.
41693A54	64x35x40	10



Chafing dish rectangular, electric heating

Scaldavivande rettangolare, riscaldamento elettrico
Chafing Dish, rechteckig, elektrisch beheizt
Chafing dish rectangulaire, chauffage électrique
Chafing dish rectangular, calefacción eléctrica

art.	dim. cm.	lt.	std	V-W
41693E54	64x35x40	10	EU	250-360
41693U54	64x35x40	10	US	120-450



Chafing dish rectangular, solid alcohol heating

Scaldavivande rettangolare a combustibile solido
Chafing Dish, rechteckig mit Brennstoff beheizt
Chafing dish rectangulaire, chauffage au combustible solide
Chafing dish rectangular, calefacción con combustible sólido

art.	dim. cm.	lt.
41989A00	67x35x35	9

With food pan GN 1/1, h 65 mm and 2 burner holders. – Con vasca GN 1/1, h 65 mm e 2 portacombustibili.



Chafing dish rectangular, solid alcohol heating

Scaldavivande rettangolare a combustibile solido
Chafing Dish, rechteckig mit Brennstoff beheizt
Chafing dish rectangulaire, chauffage au combustible solide
Chafing dish rectangular, calefacción con combustible sólido

art.	dim. cm.	lt.
41989A01	67x35x45	9

With food pan GN 1/1, h 65 mm and 2 burner holders. – Con vasca GN 1/1, h 65 mm e 2 portacombustibili.



Chafing dish rectangular, solid alcohol heating

Scaldavivande rettangolare a combustibile solido
Chafing Dish, rechteckig mit Brennstoff beheizt
Chafing dish rectangulaire, chauffage au combustible solide
Chafing dish rectangular, calefacción con combustible sólido

art.	dim. cm.	lt.
41694A54	64x35x40	10



Chafing dish rectangular, electric heating

Scaldavivande rettangolare, riscaldamento elettrico
Chafing Dish, rechteckig, elektrisch beheizt
Chafing dish rectangulaire, chauffage électrique
Chafing dish rectangular, calefacción eléctrica

art.	dim. cm.	lt.	std	V-W
41694E54	64x35x40	10	EU	250-360
41694U54	64x35x40	10	US	120-450



Chafing dish rectangular, solid alcohol heating

Scaldavivande rettangolare a combustibile solido
Chafing Dish, rechteckig mit Brennstoff beheizt
Chafing dish rectangulaire, chauffage au combustible solide
Chafing dish rectangular, calefacción con combustible sólido

art.	dim. cm.
41694A02	64x35x33

Equipped with 2 fuel-holders. – Fornito con 2 portacombustibili.



Chafing dish rectangular, solid alcohol heating

Scaldavivande rettangolare a combustibile solido
Chafing Dish, rechteckig mit Brennstoff beheizt
Chafing dish rectangulaire, chauffage au combustible solide
Chafing dish rectangular, calefacción con combustible sólido

art.	Ø cm.	h. cm.
41694A60	66	30

Equipped with 4 fuel-holders. – Fornito con 4 portacombustibili.



Coffee dispenser plates, stainless steel

Targhette per scaldacaffè, inox
Kaffeespender Schilder, Edelstahl Rostfrei
Étiquettes pour réchaud à café, inox
Etiquetas para calentador de café, inox

art.	dim. cm.	des.
58341-EC	11x33	Coffee
58341-EW	11x33	Water
58341-EM	11x33	Milk
58341-ET	11x33	Tea
58341-NN	11x33	Clear



Round food pan, stainless steel

Portavivande tondo, inox
Einsatzbehälter, rund, Edelstahl Rostfrei
Bac rond, inox
Baño-maria redondo, inox

art.	Ø cm.	h. cm.	lt.
58136-EA	33	6,0	3,5
58136-EB	40	7,5	6,0

Round porcelain insert

Inserto tondo, porcellana
Porzellaneinsatz, rund
Bac rond, porcelaine
Baño-maria redondo, porcelana

art.	Ø cm.	h. cm.
44352-30	33	5,7
44352-40	40	7,5

Round porcelain insert, 2 food sections

Inserto tondo, porcellana, 2 scomparti
Porzellaneinsatz 2-tlg., rund
Bac rond, porcelaine, 2 compartements
Baño-maria redondo, porcelana 2 compartimentos

art.	Ø cm.	h. cm.
44355-30	33	5,7
44355-40	40	7,5

Food pan GN 1/1, stainless steel

Bacinella GN 1/1, inox
GN-Behälter 1/1, Edelstahl Rostfrei
Bac GN 1/1, inox
Baño-maria GN 1/1, inox

art.	dim. cm.
14102-04	53x32,5x4
14102-06	53x32,5x6,5

Food pan GN 1/1, porcelain

Bacinella GN 1/1, porcellana
GN-Behälter 1/1, Porzellan
Bac GN 1/1, porcelaine
Baño-maria GN 1/1, porcelana

art.	dim. cm.
44332-03	53x32,5x2
44332-06	53x32,5x6,5

Fuel Holder, stainless steel

Portacombustibile, inox
Brennstoffhalterung, Edelstahl Rostfrei
Porte Brûleur, inox
Contenedor de combustible, inox

art.	Ø cm.	h. cm.
41809-09	9	6,5

Suitable for chafing dishes items 41693 and 41694. – Adatto per gli scaldavivande art. 41693 e 41694.

Fuel Holder, stainless steel

Portacombustibile, inox
Brennstoffhalterung, Edelstahl Rostfrei
Porte Brûleur, inox
Contenedor de combustible, inox

art.	Ø cm.	h. cm.
58132-FB	10	7,5

Suitable for chafing dishes items 58152 and 58156. – Adatto per gli scaldavivande art. 58152 e 58156.

Fuel Holder, stainless steel

Portacombustibile, inox
Brennstoffhalterung, Edelstahl Rostfrei
Porte Brûleur, inox
Contenedor de combustible, inox

art.	Ø cm.	h. cm.
58132-FA	10	5,5

Suitable for coffee urn item 58351. – Adatto per gli scaldacaffè art. 58351.

BUFFET & PRESENTATION



Electric heating units

Piastre elettriche
Elektro-Heizelemente
Corps de chauffe électriques
Calentadores eléctricos

art.	dim. cm.	V-W
58132-KE	20x25	220-380
58132-KU	20x25	110-450

For rectangular chafers and round cm 40. – Per chafer rettangolari e tondi cm 40.



art.	dim. cm.	V-W
58136-KE	20x20	220-200
58136-KU	20x20	110-240

For round chafer cm 33. – Per chafer tondo cm 33.



art.	Ø cm.	For/Per	V-W
58341-KE	13,5	58351E	220-80
58341-KU	13,5	58351U	110-170
58357-FE	13,5	58357E	230-1000
58357-FU	13,5	58357U	115-1000
58355-FE	13,5	58355E	230-500
58355-FU	13,5	58355U	115-500



Jelly fuel

Gel combustibile
Brenngel
Gel combustibile
Combustible gel

art.	lt.	gr.	U. Pack
41695-15	-	200	2
41695-10	1	-	-
41695-50	5	-	-
41695-90	10	-	-



Coffee urn, solid alcohol heating

Scaldacaffè, riscaldamento a combustibile solido
Kaffeedispenser mit Brennstoff beheizt
Réchaud à café, chauffage au combustible solide
Calentador de café, calefacción con combustible sólido

art.	dim. cm.	lt.
41903-10	31x33,5x54,5	10,5



Soup kettle

Zuppiera
Suppenkessel
Marmite à soupe
Olla de sopa

art.	Ø cm.	h. cm.	lt.
49790-09	48	32	10



SERIES VERSAILLES

DINING ROOM TROLLEYS
CARRELLI SALA



STANDARD FINISHING ROSEWOOD COLOR
FINITURA STANDARD TINTA PALISSANDRO
STANDARD-AUSFÜHRUNG IN PALISSANDERFARBE
FINISSAGE STANDARD COULEUR PALISSANDRE
ACABADO ESTÁNDAR DE COLOR PALISSANDRO

N
WALNUT | NOCE
NUSSBRAUN | NOYER | NOGAL

M
MAHOGANY | MOGANO
MAHAGONI-BRAUN | ACAJOU | CAOBA

R
OAK | ROVERE
EICHENBRAUN | CHÊNE | ROBLE

Main structure and tops in plywood with reinforced edges. Legs in beechwood. Standard finishing rosewood color. Other colors: walnut, mahogany and oak. Standard swivel casters in antistatic rubber, on request polyurethane casters. All trolleys are available equipped with rubber bumper.

Struttura portante, piani di servizio in legno multistrato con bordi massicci. Gambe in massello di faggio. Finitura standard tinta palissandro. Su richiesta colori: noce, mogano e rovere. Ruote standard in gomma antistatica, optional ruote in poliuretano. Tutti i carrelli possono essere dotati di profilo paraurti.



Roast beef/stew trolley

Carrello arrosti/bolliti
Rinderbrust-/Fleischgerichtewagen
Chariot à rôtis
Carro roast beef

art.	dim. cm.	Kg.	V	W	color	col.
58874-11	126x62x109	54	120	600	rosewood	●
58874M11	126x62x109	54	120	600	mahogany	●
58874N11	126x62x109	54	120	600	walnut	●
58874R11	126x62x109	54	120	600	oak	●
58874-22	126x62x109	54	230	700	rosewood	●
58874M22	126x62x109	54	230	700	mahogany	●
58874N22	126x62x109	54	230	700	walnut	●
58874R22	126x62x109	54	230	700	oak	●

18-10 s/s revolving top adjustable up to 180°, mirror polish finishing - 4 swivel casters, 2 with brakes, bain-marie tank with 3 GN 1/2 10 litres each - removable wilsonart cutting board mm 354x265 revolving plate rack and removable knife holder in 18-10 s/s - 2 taps for water discharge - 2 heating units 700W each - 1 built in plug, backside - 3 built-in plugs, deck downside - 2 pipe plugs - cable - 3 switches, (1 magneto-termic). – Cloche inox 18-10 lucido a specchio, apertura a scomparsa a 180° - 4 ruote pivotanti, 2 con freno – vasca bagnomaria con 3 portavivande GN 1/2 da lt 10 cad. - tagliere mobile in wilsonart, mm 354x265 - portapiatti ribaltabile e portacoltelli estraibile in acciaio inox 18-10 - 2 rubinetti di scarico a sfera - 2 piastre elettriche da 700W cad. - 1 spina ad incasso (posteriore carrello) - 3 prese ad incasso (sotto piano carrello) - 2 spine a pipa - cavo di alimentazione - 3 interruttori di cui 1 magnetotermico.



Flambé trolley

Carrello flambé
Flambierwagen
Chariot à flamber
Carro flambé

art.	dim. cm.	Kg.	color	col.
58876-00	122x58,5x89,5	44,5	rosewood	●
58876M00	122x58,5x89,5	44,5	mahogany	●
58876N00	122x58,5x89,5	44,5	walnut	●
58876R00	122x58,5x89,5	44,5	oak	●

4 swivel casters, 2 with brakes - upper deck in 18-10 stainless steel mm 540x1042 with bottle holder protection ring - 2 lower wooden decks - cabinet for gas cylinder - gas/burning/lighting unit - piezoelectric lighting device - operating with liquid butan gas, 2,75 kg rechargeable cylinder (lasting for 20 hours about) or 1,8 kg cylinder - trolley supplied without cylinder. – 4 ruote pivotanti di cui 2 con freno - pianale inox mm 540x1042 completo di barriera portabottiglie - 2 piani d'appoggio inferiori in legno - vano porta bombole con sportello di chiusura - gruppo gas/bruciatore/accenditore - dispositivo di accensione piezoelettrico - funzionamento a gas liquido butano in bombola ricaricabile da kg 2,75 (autonomia 20 ore circa) oppure da kg 1,8 - bombola NON fornita.



Standard gueridon trolley

Carrello gueridon, standard
Gueridonwagen, Standard
Chariot gueridon, standard
Carro gueridon estándar

art.	dim. cm.	Kg.	color	col.
58886-00	77,5x51x74,5	14,5	rosewood	●
58886M00	77,5x51x74,5	14,5	mahogany	●
58886N00	77,5x51x74,5	14,5	walnut	●
58886R00	77,5x51x74,5	14,5	oak	●

4 swivel casters without brakes. Upon request, the trolley can be supplied equipped with intermediate shelf. – 4 ruote pivotanti, senza freno. Su richiesta è possibile fornire il carrello dotato di piano intermedio.



De luxe gueridon trolley

Carrello gueridon, de luxe
Gueridonwagen, Luxus-Ausführung
Chariot gueridon, de luxe
Carro gueridon, de luxe

art.	dim. cm.	Kg.	color	col.
58887-00	77,5x51x74,5	16,5	rosewood	●
58887M00	77,5x51x74,5	16,5	mahogany	●
58887N00	77,5x51x74,5	16,5	walnut	●
58887R00	77,5x51x74,5	16,5	oak	●

4 swivel casters without brakes - 6 compartments drawer – removable upper deck. – 4 ruote pivotanti, senza freno - cassetteria a sei scomparti – piano d'appoggio estraibile.



Flambé trolley, electric

Carrello flambé, elettrico
Flambierwagen, elektrisch
Chariot à flamber, électrique
Carro flambé, eléctrico

art.	dim. cm.	Kg.	V	W	color	col.
58876-01	122x58,5x89,5	44,5	230	2300	rosewood	●
58876M01	122x58,5x89,5	44,5	230	2300	mahogany	●
58876N01	122x58,5x89,5	44,5	230	2300	walnut	●
58876R01	122x58,5x89,5	44,5	230	2300	oak	●

4 swivel casters, 2 with brakes – upper deck in 18-10 stainless steel mm 540x1042 with protection ring – 2 lower wooden decks - built-in electric heating unit, high-light, ø 32 cm, ceramic heating surface ø 26 cm - 1 built-in plug, backside - cable - adjustable heat control unit and 1 magneto termic switch. – 4 ruote pivotanti di cui 2 con freno - pianale inox mm 540x1042 completo di barriera perimetrale - 2 piani d'appoggio inferiori in legno - piastra elettrica high-light da incasso ø 32 cm, piano riscaldante in vetroceramica ø 26 cm - 1 spina ad incasso (posteriore carrello) - cavo di alimentazione - regolatore di energia ed interruttore magnetotermico.



Flambé trolley, 2 burners

Carrello flambé, 2 fuochi
Flambierwagen, 2 Brenner
Chariot à flamber, 2 feux
Carro flambé, 2 fuegos

art.	dim. cm.	Kg.	color	col.
58877-00	122x58,5x89,5	46,5	rosewood	●
58877M00	122x58,5x89,5	46,5	mahogany	●
58877N00	122x58,5x89,5	46,5	walnut	●
58877R00	122x58,5x89,5	46,5	oak	●

4 swivel casters, 2 with brakes - upper deck in 18-10 stainless steel mm 540x1042 with protection ring - 2 lower wooden decks - cabinet for gas cylinder – 2 gas/burning/lighting units - piezoelectric lighting device - operating with liquid butan gas, 2,75 kg rechargeable cylinder (lasting for 20 hours about) or 1,8 kg cylinder - trolley supplied without cylinder. – 4 ruote pivotanti di cui 2 con freno - pianale inox mm 540x1042 completo di barriera perimetrale – 2 piani d'appoggio inferiori in legno - vano porta bombole con sportello di chiusura- 2 gruppi gas/bruciatore/accenditore - dispositivo di accensione piezoelettrico - funzionamento a gas liquido butano in bombola ricaricabile da kg 2,75 (autonomia 20 ore circa) oppure da kg 1,8 - bombola NON fornita.



Mini flambé trolley

Carrello mini-flambé
Flambierwagen, Mini-Ausführung
Chariot à flamber, mini
Mini carro flambé

art.	dim. cm.	Kg.	color	col.
58875-00	77,5x51x74,5	22	rosewood	●
58875M00	77,5x51x74,5	22	mahogany	●
58875N00	77,5x51x74,5	22	walnut	●
58875R00	77,5x51x74,5	22	oak	●

4 swivel casters without brakes - upper deck in 18-10 stainless steel, satin finishing - lower deck with bottle holder. – 4 ruote pivotanti, senza freno - piano superiore in acciaio inox 18-10, satinato - vano inferiore con portabottiglie.



Hors d'oeuvre trolley

Carrello antipasti
Vorspeisewagen
Chariot à hors d'oeuvres
Carro entremeses

art.	dim. cm.	Kg.	color	col.
58878-00	122x62x106	38	rosewood	●
58878M00	122x62x106	38	mahogany	●
58878N00	122x62x106	38	walnut	●
58878R00	122x62x106	38	oak	●

4 swivel casters, 2 with brakes – methacrylate revolving cloche – hors d'oeuvre inserts carrying deck in 18-10 s/s with protection ring - 9 hors d'oeuvre glass inserts, mm 123x203. Upon request, the trolley can be supplied equipped with intermediate shelf. – 4 ruote pivotanti, 2 con freno - cupola in metacrilato con apertura a scomparsa - piano porta-vaschette antipasti in acciaio inox 18-10 con barriera perimetrale - 9 vaschette antipasti in vetro, dim. mm 123 x 203. Su richiesta è possibile fornire il carrello dotato di piano intermedio.



Cooled hors d'oeuvre trolley

Carrello antipasti, refrigerato
Vorspeisewagen, gekühlt
Chariot à hors d'oeuvres, réfrigéré
Carro entremeses, refrigerado

art.	dim. cm.	Kg.	color	col.
58879-00	122x62x106	38	rosewood	●
58879M00	122x62x106	38	mahogany	●
58879N00	122x62x106	38	walnut	●
58879R00	122x62x106	38	oak	●

4 swivel casters, 2 with brakes - methacrylate revolving cloche – eutectic pads container with 18-10 stainless steel cover - 8 eutectic pads 2,2 lbs each, mm 170x200 - 9 hors d'oeuvre glass inserts, mm 123x203. Upon request, the trolley can be supplied equipped with intermediate shelf. – 4 ruote pivotanti di cui 2 con freno - cupola in metacrilato, con apertura a scomparsa - copertura vasca per contenitori eutettici in acciaio inox 18-10 - 8 contenitori eutettici da kg 1 cadauno, dim. mm 170 x 200 - 9 vaschette antipasti in vetro, dim. mm 123 x 203. Su richiesta è possibile fornire il carrello dotato di piano intermedio.



Patisserie trolley

Carrello pasticceria Omicron
Kuchen-/Nachspeisewagen
Chariot à pâtisserie
Carro postres

art.	dim. cm.	Kg.	color	col.
58880-00	113x56,5x104	57	rosewood	●
58880M00	113x56,5x104	57	mahogany	●
58880N00	113x56,5x104	57	walnut	●
58880R00	113x56,5x104	57	oak	●

Methacrylate revolving cloche, bifrontal rotation – 4 swivel casters, 2 with brakes - 1 upper fixed deck in metacrilat mm 200x750 - 1 upper removable deck in metacrilat mm 400x750 – 2 revolving plate racks in 18-10 stainless steel - 2 lower wooden decks. – Cupola tonda in metacrilato, montata su guide laterali, che ne permettono la rotazione nei due sensi - 4 ruote pivotanti di cui 2 con freno - 1 piano fisso in metacrilato mm 200x750 - 1 piano mobile in metacrilato mm 400x750 - 2 portapiatti ribaltabili in acciaio inox 18-10 - 2 piani d'appoggio inferiori in legno.



Cake and cheese trolley

Carrello dolci-formaggi
Dessert-/Käsewagen
Chariot à fromages et desserts
Carro postres/quesos

art.	dim. cm.	Kg.	color	col.
58882-00	122x62x106	38	rosewood	●
58882M00	122x62x106	38	mahogany	●
58882N00	122x62x106	38	walnut	●
58882R00	122x62x106	38	oak	●

4 swivel casters, 2 with brakes - methacrylate revolving cloche - beech texwood cutting board mm 728x424 - revolving plate rack in 18-10 stainless steel. Upon request, the trolley can be supplied equipped with intermediate shelf. – 4 ruote pivotanti di cui 2 con freno - cupola in metacrilato, con apertura a scomparsa - tagliere in texwood faggio naturale mm 728 x 424 - portapiatti ribaltabile in acciaio inox 18-10. Su richiesta è possibile fornire il carrello dotato di piano intermedio.



Cooled cake trolley

Carrello dolci, refrigerato
Dessertwagen, gekühlt
Chariot à desserts, réfrigéré
Carro postres, refrigerado

art.	dim. cm.	Kg.	color	col.
58884-00	122x62x106	47,5	rosewood	●
58884M00	122x62x106	47,5	mahogany	●
58884N00	122x62x106	47,5	walnut	●
58884R00	122x62x106	47,5	oak	●

4 swivel casters, 2 with brakes - metacrilat revolving cloche – eutectic pads container with 18-10 stainless steel cover - 8 eutectic pads 2,2 lbs each, mm 170x200 - revolving plate rack in 18-10 stainless steel. Upon request, the trolley can be supplied equipped with intermediate shelf. – 4 ruote pivotanti di cui 2 con freno - cupola in metacrilato, con apertura a scomparsa - vaschetta porta contenitori eutettici con copertura in acciaio inox 18-10 - 8 contenitori eutettici da kg 1 cadauno, mm 170x200 - portapiatti ribaltabile in acciaio inox 18-10. Su richiesta è possibile fornire il carrello dotato di piano intermedio.



Cooled mini cheese trolley

Carrello mini-formaggi, refrigerato
Käsewagen, gekühlt, Mini-Ausführung
Chariot à fromages, réfrigéré, mini

Mini carro quesos, refrigerado

art.	dim. cm.	Kg.	color	col.
58895-00	77,5x51x94	16,5	rosewood	●
58895M00	77,5x51x94	16,5	mahogany	●
58895N00	77,5x51x94	16,5	walnut	●
58895R00	77,5x51x94	16,5	oak	●

4 swivel casters without brakes - metacrilat roll-top cover, opening at 90° - eutectic pads container with stainless steel cover (eutectic pads incl.) - 1 removable cutting board, GN 1/1 - revolving plate rack in stainless steel. - 4 ruote pivotanti senza freno - cupola in metacrilato, con apertura a 90° - vaschetta porta contenitori eutettici (eutettici inclusi) con copertura in acciaio inox - 1 tagliere mobile, GN 1/1 - portapiatti ribaltabile in acciaio inox.



Wine trolley

Carrello vini
Weinwagen
Chariot à vins
Carro de vinos

art.	dim. cm.	Kg.	color	col.
58897-00	122x62x92	39	rosewood	●
58897M00	122x62x92	39	mahogany	●
58897N00	122x62x92	39	walnut	●
58897R00	122x62x92	39	oak	●

4 swivel casters, 2 with brakes - upper deck with stainless steel bottle holder ring - bottle caps and wine card compartment - 6 compartments for bottle coolers (bottle coolers included) - glass rack, deck downside - lower deck with bottle rack, 12 compartments. - 4 ruote pivotanti di cui 2 con freno - barriera porta bottiglie in acciaio inox - contenitore per tappi e carta vini - vano con 6 glacette (glacette incluse) - rastrelliera porta bicchieri, sotto piano carrello - piano inferiore con rastrelliera porta bottiglie, 12 posti.



Liqueur trolley

Carrello liquori
Aperitif-/Digestivwagen
Chariot à liqueurs
Carro licores

art.	dim. cm.	Kg.	color	col.
58889-00	124x68,5x104	37	rosewood	●
58889M00	124x68,5x104	37	mahogany	●
58889N00	124x68,5x104	37	walnut	●
58889R00	124x68,5x104	37	oak	●

4 swivel casters, 2 with brakes - bottle holder protection ring in 18-10 stainless steel. - 4 ruote pivotanti di cui 2 con freno - barriera portabottiglie in acciaio inox 18-10.



Serving trolley

Carrello servizio
Servierwagen
Chariot à servir
Carro de servicio

art.	dim. cm.	Kg.	color	col.
58891-00	122x58,5x89,5	35,5	rosewood	●
58891M00	122x58,5x89,5	35,5	mahogany	●
58891N00	122x58,5x89,5	35,5	walnut	●
58891R00	122x58,5x89,5	35,5	oak	●

4 swivel casters, 2 with brakes - removable upper deck and wooden drawer. Upon request, the trolley can be supplied equipped with intermediate shelf. - 4 ruote pivotanti di cui 2 con freno - piano estraibile e cassetto in legno. Su richiesta è possibile fornire il carrello dotato di piano intermedio.



Sherbet/ice cream trolley

Carrello sorbetti

Sorbetwagen

Chariot à sorbets/glacés

Carro sorbetes

art.	dim. cm.	Kg.	color	col.
58893-00	122x62x93	43	rosewood	●
58893M00	122x62x93	43	mahogany	●
58893N00	122x62x93	43	walnut	●
58893R00	122x62x93	43	oak	●

4 swivel casters, 2 with brakes - 4 18-10 stainless steel insulated sherbet holders (lt 1,2 each) - flatware drawer - revolving plate rack and ice cream scoops holder in stainless steel. – 4 ruote pivotanti di cui 2 con freno - 4 sorbettiere termiche in acciaio inox 18-10 da lt 1,2 cadauna - cassetto portaposate - portapiatti ribaltabile e portapalette-gelato in acciaio inox 18-10.



Round trolley

Carrello tondo

Servierwagen, rund

Chariot rond

Carro redondo

art.	Ø cm.	h. cm.	Kg.	color	col.
58888-00	60	89,5	23	rosewood	●
58888M00	60	89,5	23	mahogany	●
58888N00	60	89,5	23	walnut	●
58888R00	60	89,5	23	oak	●

4 swivel casters without brakes – removable upper deck - perimeter barrier.
4 ruote pivotanti, senza freno - piano d'appoggio laterale estraibile - barriera perimetrale.



PP

RUBBERMAID Serving trolley

Carrello servizio

Servierwagen

Chariot à servir

Carro de servicio

art.	dim. cm.	col.
49995-04	97x51x99	●

Swivel casters for easy manoeuvrability. Ergonomic handles, high load capacity 135 kg (45 kg per shelf). Ultra-quiet mark-resistant casters. – Maniglie ergonomiche arrotondate, pannelli laterali e bordo paraurti arrotondato. Portata 135 kg (45 kg per ripiano). Ruote girevoli, antitraccia e silenziose.



SERIES 14000

STORAGE & TRANSPORT
STOCCAGGIO E TRASPORTO



Molded in one-piece with double-wall construction made of polypropylene. Resistant to shock, high temperatures and chemicals. Designed to give optimum protection to glass and chinaware as well as to maximise water circulation and drying in professional dishwasher. Easy and quickly stackable without tools or screws. Base racks have comfortable hand grips on all four sides facilitating handling.

Realizzati in polipropilene, stampati unipezzo a doppio spessore. Resistenti agli urti ed alte temperature, agenti chimici e residui alimentari. Concepiti per assicurare una protezione ottimale a bicchieri e stoviglie, il loro design permette inoltre una perfetta circolazione dell'acqua di lavaggio ed una rapida e perfetta asciugatura. Facili e veloci da impilare. Leggeri e maneggevoli, tutti i cestelli di base sono dotati di maniglie integrali su tutti i lati.



9-Compartment base

Cestello 9 bicchieri
Grundkorb für 9 Gläser
Panier de base 9 verres
Cesta 9 compartimentos

art. mm.
14001-09 500x500x103

**Compartments / Scosparti 151x151x42 mm.
ø max 151 mm.**



9-Compartment extender

Estensore per cestello 9 bicchieri
Aufsatz zum Grundkorb für 9 Gläser
Réhausse pour panier de base 9 verres
Extensión 9 compartimentos

art. mm.
14003-09 500x500x45

**Compartments / Scosparti 151x151x88 mm.
ø max 151 mm.**



16-Compartment base

Cestello 16 bicchieri
Grundkorb für 16 Gläser
Panier de base 16 verres
Cesta 16 compartimentos

art. mm.
14001-16 500x500x103

**Compartments / Scosparti 112x112x88 mm.
ø max 112 mm.**



16-Compartment extender

Estensore per cestello 16 bicchieri
Aufsatz zum Grundkorb für 16 Gläser
Réhausse pour panier de base 16 verres
Extensión 16 compartimentos

art. mm.
14003-16 500x500x45

**Compartments / Scosparti 112x112x42 mm.
ø max 112 mm.**



25-Compartment base

Cestello 25 bicchieri
Grundkorb für 25 Gläser
Panier de base 25 verres
Cesta 25 compartimentos

art. mm.
14001-25 500x500x103

**Compartments / Scosparti 88x88x88 mm.
ø max 88 mm.**



25-Compartment extender

Estensore per cestello 25 bicchieri
Aufsatz zum Grundkorb für 25 Gläser
Réhausse pour panier de base 25 verres
Extensión 25 compartimentos

art. mm.
14003-25 500x500x45

**Compartments / Scosparti 88x88x42 mm.
ø max 88 mm.**



36-Compartment base

Cestello 36 bicchieri
Grundkorb für 36 Gläser
Panier de base 36 verres
Cesta 36 compartimentos

art. mm.
14001-36 500x500x103

**Compartments / Scosparti 73x73x88 mm.
ø max 73 mm.**



36-Compartment extender

Estensore per cestello 36 bicchieri
Aufsatz zum Grundkorb für 36 Gläser
Réhausse pour panier de base 36 verres
Extensión 36 compartimentos

art. mm.
14003-36 500x500x45

**Compartments / Scosparti 73x73x42 mm.
ø max 73 mm.**



49-Compartment base

Cestello 49 bicchieri
Grundkorb für 49 Gläser
Panier de base 49 verres
Cesta 49 compartimentos

art. mm.
14001-49 500x500x103

**Compartments / Scosparti 73x73x42 mm.
ø max 73 mm.**



49-Compartment extender
 Estensore per cestello 49 bicchieri
 Aufsatz zum Grundkorb für 49 Gläser
 Réhausse pour panier de base 49 verres
 Extensión 49 compartimentos

art. mm.
 14003-49 500x500x45

**Compartments / Scomparti 62x62x42 mm.
 ø max 62 mm.**



Open extender
 Estensore aperto
 Universalrand ohne Einteilung
 Réhausse sans cloisons
 Extensión abierta

art. mm.
 14004-00 500x500x42



Rack cover
 Coperchio per cestelli
 Deckel für Körbe
 Couvercle à panier
 Tapa para cestas

art. mm.
 14011-00 505x505x25



Open rack
 Cestello universale
 Universal-Korb
 Panier universel
 Cesta universal

art. mm.
 14010-00 500x500x103



Cutlery rack
 Cestello per posate
 Besteckkorb
 Panier à couverts
 Cesta para cubiertos

art. mm.
 14006-00 500x500x103



Plates & trays rack
 Cestello per piatti e vassoi
 Tablett- u. Tellerkorb mit Fingern
 Panier à plateaux et assiettes
 Cesta para bandejas y platos

art. mm.
 14008-00 500x500x103

For 18 flat plates or 9 trays max. 460 mm.
 Per 18 piatti piani oppure 9 vassoi max. 460 mm.



Tray rack, open
 Cestello per vassoi, aperto
 Tablettkorb mit Fingern, offen
 Panier à plateaux, ouvert
 Cesta abierto para bandejas

art. mm.
 14007-00 500x500x103

For trays over 460 mm. Capacity 9 pcs.
 Per vassoi oltre 460 mm. Cap. 9 pz.



Clip tags, set 10 pcs
 Etichette di identificazione, set 10 pz
 Markierungsklipp, 10 Stk.
 Clips, set 10 pcs
 Etiquetas, set 10 pz

art. mm.
 14013-00 80x40



Cutlery holder 8 compartments
 Cestello per posate 8 scomparti
 Besteckkorb, 8 Unterteilungen
 Panier à couverts 8 compartiments
 Cesta para cubiertos

art. mm.
 14015-08 426x206x150

For 200/250 pcs cutlery. – Per 200/250 posate.



SS

Cutlery dispenser

Porta posate
Besteckbehälter
Récipient à couverts
Contenedor para cubiertos

art.	cm.
42587-04	26x30x20



SS

Cutlery holder

Cestello porta posate
Besteckbehälter
Récipient à couverts
Cestillo para cubiertos

art.	Ø cm.	h. cm.
42586-10	10	14



PE

Cutlery holder

Cestello porta posate
Besteckbehälter
Récipient à couverts
Cestillo para cubiertos

art.	Ø cm.	h. cm.
42586-09	9,5	13,5



PP

Cutlery dispenser

Porta posate
Besteckbehälter
Récipient à couverts
Contenedor para cubiertos

art.	cm.
42585-06	54x33x13



PE

Cutlery dispenser

Porta posate
Besteckbehälter
Récipient à couverts
Contenedor para cubiertos

art.	cm.	GN	h. cm.
42585-04	32,5x53	1/1	10



PP

Cutlery box lid

Coperchio per porta posate
Deckel für Besteckbehälter
Couvercle pour récipient à couverts
Tapa para contenedor cubiertos

art.	cm.
42585-00	32,5x53x2



Dolly with handle

Carrello con maniglione
Transportwagen mit Griff
Chariot avec poignée
Carretilla con manillar

art.	cm.	Kg.
44023-00	54x54x75	10

Polypropylene base. – Base in PP.



Dolly without handle

Carrello senza maniglione
Transportwagen ohne Griff
Chariot sans poignée
Carretilla sin manillar

art.	cm.	Kg.
44024-00	54x54	8,5

Polypropylene base. – Base in PP.



Dolly, aluminum/ABS

Carrello, alluminio/ABS
Fahrgestell, Aluminium/ABS
Chariot, aluminium/ABS
Carro, aluminio/ABS

art.	cm.
44975C50	51x51



SS

Dolly with handle
 Carrello con maniglione
 Transportwagen mit Griff
 Chariot avec poignée
 Carretilla con manillar

art. cm.
 44025-50 55x55x9

Removable handle, with drip and drain plug. Load 60 kg.
 Manico estraibile, tappo di scarico. Carico 60 kg.



Dust cover
 Copertura protettiva
 Schutzhülle
 Housse de protection
 Cuberta protectora

art. cm.
 44009-00 55x55x122



SS

Trolley 3 levels
 Carrello 3 livelli
 3-stöckiger Wagen
 Chariot à 3 étages
 Carro 3 pisos

art. cm.
 44020-21 100x50x178,5

Suitable for 24 racks.
 Carico verticale per 24 cestelli.



PP

Multipurpose box
 Recipiente
 Behälter
 Conteneur multiservice
 Contenedor

art. cm.
 44031-04 52x39x12,7
 44031-05 52x39x17,7

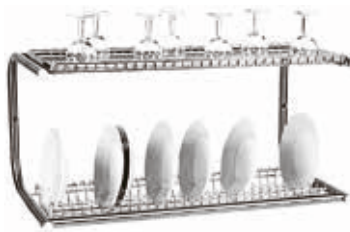

SS

Wall draining rack
 Scolapiatti a muro
 Wand-Trockengestell
 Egouttoir au mur
 Escurridor mural de platos

art. cm.
 44029-00 87x30x20

Load/Carico: 70 kg.



Wire dish rack
 Porta piatti in filo metallo/rilsan
 Tellergestell
 Porte-assiettes

Porta platos

art.	Ø cm.	h. cm.
44047-17	17	30
44047-19	19	30
44047-22	22	30
44047-25	25	30
44047-28	28	30



SS

Dish dolly
 Carrello portapiatti
 Teller-Transportwagen
 Chariot porte-assiettes
 Carro porta platos

art. cm.
 44027-00 74x61x81

Load/Carico max: 240 kg.



PE

Adjustable dish dolly
 Carrello portapiatti regolabile
 Teller-Transportwagen, einstellbar
 Chariot de stockage d'assiettes réglable
 Carro ajustable para platos

art.
 49304-06

With dust cover and 4 dividers. Dishes Ø cm 16-32, capacity 180/400 pcs. – Con copertura vinilica e 4 divisori. Per piatti Ø cm16-32, capienza 180/400 pz.

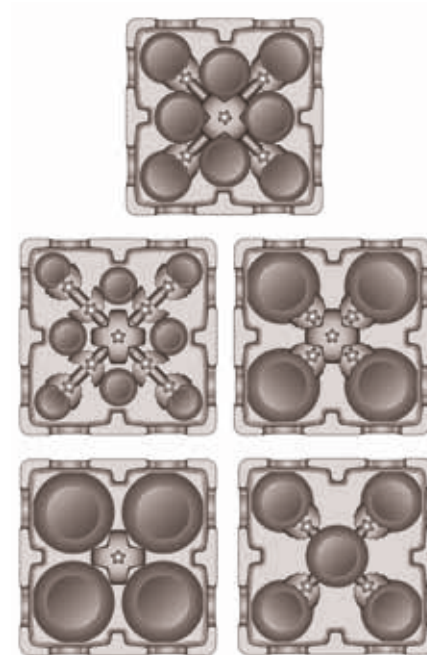

CROCKERY TRANSPORT BOX
CONTENITORE PER IL TRASPORTO DI STOVIGLIE

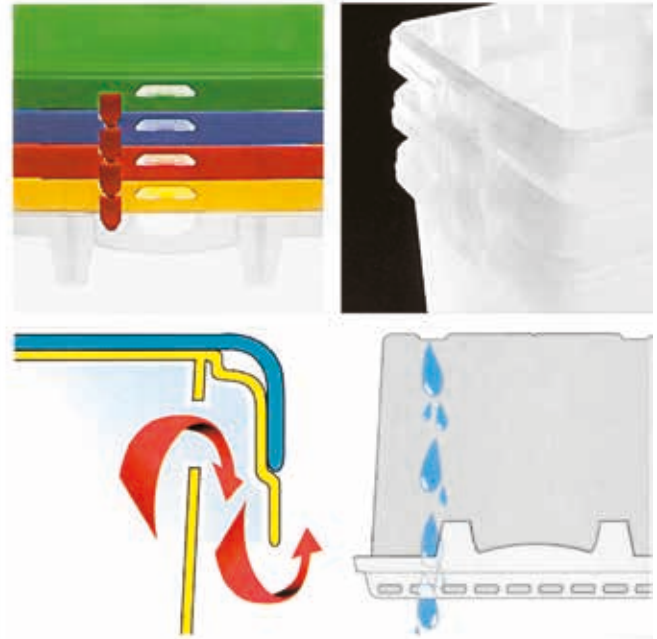

Clear polypropylene construction, full compliance with food contact requirements. A removable tower insert provides total flexibility. Strong, it prevents dish breakage in transport. Dimensions suitable to EURO-pallets. Lids are tightly fitting, hygienic, dish-washer safe. Covers available in different colors, assure easy and quick content identification. Stackable once empty, their strongness provides high loading density once full. Ventilation holes assure constant air circulation. Design studied to enable water flow while washing.

Contenitori in polipropilene trasparente per alimenti. Estremamente resistenti alle sollecitazioni, offrono protezione sicura nel trasporto. Dimensioni adatte a EURO-pallets. Adatti al lavaggio in lavastoviglie, design studiato per consentire il defluire dell'acqua. Coperchi di colore diverso facilitano l'individuazione del contenuto. Impilabili, a pieno la loro robustezza consente un'elevata capacità di sovrapposizione. Fessure di aerazione per un costante ricambio d'aria.



Storage box
Contenitore
Korb
Panier
Contenedor

art.	cm.	lt.
44040-40	40x40x31,5	32



Base insert
Fondo piatto
Flach-Einsatz
Plateau double fond
Base plana

art.	cm.
44042-00	40x40



Cross insert
Inserto croce
Kreutz-Einsatz
Cloison à croix
Separador a cruz

art.	cm.
44043-00	40x40



Cover
Coperchio
Deckel
Couvercle
Tapa

art.	col.
44041-00	○
44041-01	●
44041-03	●



Cover
Coperchio
Deckel
Couvercle
Tapa

art.	col.
44041-04	●
44041-05	●



Tower insert
Tubo fermapiatti
Rohr-Einsatz
Tuyau
Tubo

art.
44044-00

SQUARE CONTAINERS CONTENITORI QUADRATI

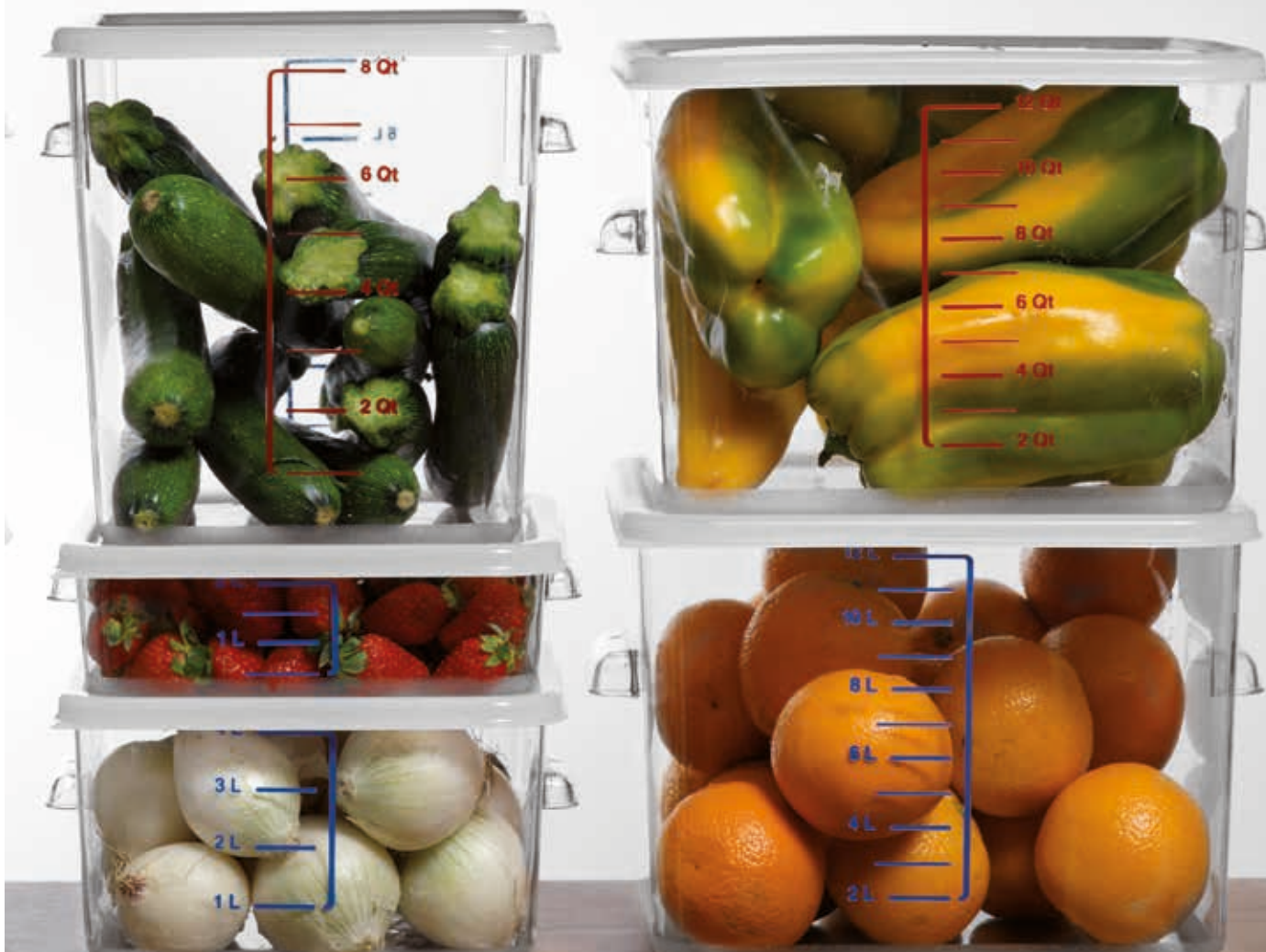

Space-saving square containers hold 25% more food than round ones. In transparent anti-breaking material to identify the contents. Graduated measurements: red for US sizes and blue for liters. Resistant handles for more practical transport and drainage holes for more accurate washing and drying. They withstand temperatures between -40°C and 100°C. Lids with hermetic pressure closure. Corner tab for easy removal. Available in two sizes that can be adapted to all containers.

Contenitori quadrati salvaspazio, conservano il 25% di alimenti in più rispetto a quelli rotondi. In materiale antirottura trasparente per identificare il contenuto. Misurazioni graduate: rosse per le misure USA e blu per i litri. Impugnatura resistente per un trasporto più pratico e fori di drenaggio per un lavaggio e un'asciugatura più accurati. Resistono a temperature comprese fra i -40°C e i 100°C. Coperchi con chiusura ermetica a pressione. Linguetta nell'angolo per una rimozione agevole. Disponibili in due misure adattabili a tutti i contenitori



Food container, copolyester

Contenitore per alimenti, copoliester
Vorratsdosen, Copoliéster
Conteneur pour aliments, copolyester
Contenedor para alimentos, copolyester

art.	cm.	lt.
44620-01	22x21x7	1,9
44620-02	22x21x12	3,8
44620-03	22x21x17,5	5,7
44620-04	22x21x22	7,6
44620-05	29x27x19	11,4
44620-06	29x27x30	17,0
44620-07	29x27x36,5	20,8



Square lid

Coperchio quadrato
Deckel, viereckig
Couvercle carré
Tapa cuadrada

art.	cm.	col.
44620-14	22x21	○
44620R14	22x21	●
44620G14	22x21	●
44620B14	22x21	●
44620Y14	22x21	●
44620V14	22x21	●

PE



Square lid

Coperchio quadrato
Deckel, viereckig
Couvercle carré
Tapa cuadrada

art.	cm.	col.
44620-17	29x27	○
44620R17	29x27	●
44620G17	29x27	●
44620B17	29x27	●
44620Y17	29x27	●
44620V17	29x27	●

PE

ROUND CONTAINERS
CONTENITORI ROTONDI



Stackable. Nest for compact storage. Reinforced rim for added strength. User-friendly, easy grip handles with dishwasher drain hole. Temperature range: -28°C to 65°C. Dishwasher safe. Tight-fitting lids with double barrier and opening flap in the corner. Writing area on the cover to specify date and content. Available in two sizes to fit all containers.

Impilabili con maniglie, in polipropilene trasparente. Resistono a temperature comprese fra i -28°C e i 65°C. Lavabili in lavastoviglie. I coperchi sono a chiusura ermetica con doppia barriera e linguetta di apertura nell'angolo. Consentono l'indicazione della data e del contenuto in un'apposita area di scrittura. Disponibili in due misure adattabili a tutti i contenitori.



PP

Food container
Contenitore per alimenti
Vorratsdosen
Conteneur pour aliments
Contenedor para alimentos

art.	Ø cm.	h. cm.	lt.
44625-03	25	19,5	5,7
44625-04	25	27,0	7,6
44625-05	33	20,5	11,4
44625-06	33	30,0	17,0
44625-07	33	35,5	20,8
44625-08*	33	35,5	20,8

*With handle. – Con manico.



PE

Round lid
Coperchio rotondo
Deckel, rund
Couvercle rond
Tapa redonda

art.	Ø cm.	col.
44625R26	25	●
44625G26	25	●
44625B26	25	●
44625-26	25	●
44625V26	25	●



PE

Round lid
Coperchio rotondo
Deckel, rund
Couvercle rond
Tapa redonda

art.	Ø cm.	col.
44625R34	33	●
44625G34	33	●
44625B34	33	●
44625-34	33	●
44625V34	33	●



PC

Food container

Contentitore per alimenti
Nahrungsmittel-Behälter
Conteneur pour aliments
Contenedor para alimentos

art.	cm.	lt.
49384-03	45,7x30x23	19,0
49384-04	45,7x66x9	19,0
49384-05	45,7x66x15	32,3
49384-06	45,7x66x23	47,0
49384-07	45,7x66x38	81,5



PC

Drain tray

Vasca di drenaggio
Abtropf-Behälter
Conteneur perforé
Contenedor para colar

art.	cm.
49384-11	45,7x66x12



PC

Lid

Coperchio
Deckel
Couvercle
Tapa

art.	cm.
49384-14	45,7x30
49384-15	45,7x66



PP

Food container

Contentitore per alimenti
Nahrungsmittel-Behälter
Conteneur pour aliments
Contenedor para alimentos

art.	cm.	lt.
49382-10	30x38x21,5	10,0
49382-23	60x49x43	23,5
49382-47	60x29x43	47,0



PP

Storage container

Carrello per derrate alimentari
Fahrbares Nahrungsmittelbehälter
Chariot mobile de stockage
Contenedor para hortalizas

art.	cm.	lt.
49381-01	74x33,5x71	79,0
49381-02	75x39,5x71	97,5
49381-03	75,5x45,5x71	116



PE

Container, round

Contentitore tondo
Behälter, rund
Conteneur, rond
Contenedor redondo

art.	Ø cm.	h. cm.	lt.
49373-01	39,7	43,5	37,9
49373-02	49,5	58,1	75,7
49373-03	55,9	69,2	121,1
49373-04	67,3	83,8	208,2



PE

Lid, round

Coperchio tondo
Deckel, rund
Couvercle, rond
Tapa redonda

art.	Ø cm.	h. cm.
49373-11	40,6	2,5
49373-12	50,5	3,2
49373-13	56,5	3,5
49373-14	67,9	5,1



PE

Dolly

Supporto mobile
Wagen
Chariot
Soporte móvil

art.	Ø cm.	h. cm.
49373-90	46,4	17

Load/Carico: 113,4 kg.



NEW

SS

Sink trolley

Carrello vasca
Obst/Gemüsewaschwagen
Chariot à évier
Carro-cuba lavado verduras

art.	cm.	lt.
44028-19	80x60x75	190

Tub with tap, brushed finish. Stamped bottom watertight, without edges. – Vasca con rubinetto, finitura spazzolata. Fondo stampato a tenuta stagna, privo di spigoli.



PE

Bread basket

Cesta pane
Brot-Korb
Corbeille à pain
Cesta pan

art.	cm.	lt.
44982-04	57x36x34	40
44982-06	66x45x35	60
44982-10	78x52x40	100



PP

Space saving box with cover

Contenitore con coperchio
Behälter mit Deckel
Réceptient avec couvercle
Contenedor con tapa

art.	cm.
44033-23	66x45x23
44033-38	67x46x38



PP

Gastronorm basket

Cesto gastronorm
Gastronorm-Korb
Panier gastronorme
Cesta gastronorm

art.	cm.
44034-11	59x39x19,5

STACKABLE CONTAINERS
CONTENITORI SOVRAPPONIBILI



Stackable containers, external dimensions 600x400 mm and 400x300 mm, they perfectly fit to 800x1200 mm EUR pallets and to 1000x1200 mm. Available in different heights and versions. High density polyethylene HDPE. A thermoplastic that offers excellent impact resistance at low temperatures (from -30°C to +70°C).

Contenitori sovrapponibili con dimensioni esterne di mm 600x400 e 400x300 perfettamente pallettizzabili su pallet EUR mm 800x1200 e 1000x1200. Disponibili in diverse altezze e versioni. Polietilene alta densità HDPE. Uno dei materiali termoplastici più dotato di resistenza all'impatto con basse temperature (da -30°C a +70°C).



Container
Contentitore
Behälter
Conteneur
Contenedor

art.	cm.	lt.
44511E21	60x40x10	21
44511E63	60x40x32	63
44511E90	60x40x45	90

Solid bottom and sides. – Fondo e pareti chiuse.



Container
Contentitore
Behälter
Conteneur
Contenedor

art.	cm.	lt.
44512E12	60x40x7	12
44512E21	60x40x10	21

Solid bottom and perforated sides.
Fondo chiuso e pareti forate.



Container
Contentitore
Behälter
Conteneur
Contenedor

art.	cm.	lt.
44513E12	60x40x7	12
44513E21	60x40x10	21

Perforated bottom and sides.
Fondo e pareti forate.



PP

Lid
Coperchio
Deckel
Couvercle
Tapa

art.	cm.
41763-00	60x40x2



PP

Lid
Coperchio
Deckel
Couvercle
Tapa

art.	cm.
41763-30	40x30x2



Container
Contentitore
Behälter
Conteneur
Contenedor

art.	cm.	lt.
44521E10	40x30x12	10

Solid bottom and sides. – Fondo e pareti chiuse.



Container
Contentitore
Behälter
Conteneur
Contenedor

art.	cm.	lt.
44521-16	40x30x17	16
44521-21	40x30x22	21
44521-31	40x30x32	31

Solid bottom and sides. – Fondo e pareti chiuse.



Container
Contentitore
Behälter
Conteneur
Contenedor

art.	cm.	lt.
44511-27	60x40x15	27
44511-34	60x40x17	34
44511-38	60x40x20	38
44511-42	60x40x22	42
44511-63	60x40x32	63
44511-90	60x40x45	90

Solid bottom and sides. – Fondo e pareti chiuse.



Container
Contentitore
Behälter
Conteneur
Contenedor

art.	cm.	lt.
44522E10	40x30x12	10

Solid bottom and perforated sides.
Fondo chiuso e pareti forate.



Container
Contentitore
Behälter
Conteneur
Contenedor

art.	cm.	lt.
44522-16	40x30x17	16
44522-21	40x30x22	21
44522-31	40x30x32	31

Solid bottom and perforated sides.
Fondo chiuso e pareti forate.



Container
Contentitore
Behälter
Conteneur
Contenedor

art.	cm.	lt.
44512-34	60x40x17	34
44512-42	60x40x22	42
44512-63	60x40x32	63
44512-90	60x40x45	90

Solid bottom and perforated sides.
Fondo chiuso e pareti forate.



Container
Contentitore
Behälter
Conteneur
Contenedor

art.	cm.	lt.
44513-34	60x40x17	34
44513-38	60x40x20	38
44513-54	60x40x29	54
44513-63	60x40x32	63
44513-90	60x40x45	90

Perforated bottom and sides.
Fondo e pareti forate.

POLYPROPYLENE CONTAINERS
CONTENITORI POLIPROPILENE



They do not hand over odours or flavours to foods. Easy to wash and disinfect after use. Light and free of protrusions and sharp edges. Resistant, hygienic, economic, 100% recyclable, suitable for industrial washing and disinfection with detergents and disinfectants, hot water, and wet vapour up to 110°C (HACCP System). Suitable to protect food thermal stresses.

Non cedono odori e sapori agli alimenti, facilmente lavabili e sanificabili. Leggeri e privi di sporgenze e spigoli vivi. Resistenti, igienici, ecologici e riciclabili al 100%. Compatibili al lavaggio e alla disinfezione industriale con detergenti e disinfettanti, acqua calda e vapore umido fino a 110°C (HACCP System). Idonei a proteggere gli alimenti da sollecitazioni termiche.



Insulated container POWERBOX

Contentitore isotermico
Thermobehälter
Conteneur isotherme
Contenedor isotérmico

art.	cm.	lt.
44961-05	64,5x40x31,5	45



Insulated container UNIVERSAL PN

Contentitore isotermico
Thermobehälter
Conteneur isotherme
Contenedor isotérmico

art.	cm.	lt.
44986-12	61x43x20	24,0
44986-17	61x43x25	33,8
44986-21	61x43x29,5	42,8
44986-28	61x43x36,5	56,7



Insulated container GN 1/2

Contentitore isotermico
Thermobehälter
Conteneur isotherme
Contenedor isotérmico

art.	cm.	lt.
44972-20	41,5x32x28,5	20,3
44972-25	41,5x32x32	21,6
44972-33	41,5x32x40	31,2



Insulated container GN 1/1

Contentitore isotermico
Thermobehälter
Conteneur isotherme
Contenedor isotérmico

art.	cm.	lt.
44970-10	60x40x17	20,2
44970-15	60x40x23	31,2
44970-20	60x40x27	38,6
44970-34	60x40x34,5	52,3



OPTIONAL 44970 - Sling & dolly

Imbragature e carrello
Gurt und Wagen
Sangle et chariot
Correa y carro

art.	cm.
44987C62	62x42
44973-10	sling
44973-20	sling



Insulated container PLUS GN 1/1

Contentitore isotermico
Thermobehälter
Conteneur isotherme
Contenedor isotérmico

art.	cm.	lt.
44978-10	68x44,5x20	24,9
44978-20	68x44,5x30	45,6



Insulated pastry container

Contentitore isotermico pasticceria
Konditorei-Thermobehälter
Conteneur isotherme à pâtisserie
Contenedor isotérmico para pastelería

art.	cm.	lt.
44974-21	68,5x48,5x27	55,8
44974-27	68,5x48,5x33	71,7
44974-31	68,5x48,5x37	82,3



Insulated container TROLLEYBOX

Contentitore isotermico
Thermobehälter
Conteneur isotherme
Contenedor isotérmico

art.	cm.	lt.
44961-04	42x42x60	60





Insulated container BOXSHOP

Contentitore isotermico
Thermobehälter
Conteneur isotherme
Contenedor isotérmico

art.	cm.	lt.
44961-02	41,5x32x32	21,6



Insulated container PIZZABOX

Contentitore isotermico
Thermobehälter
Conteneur isotherme
Contenedor isotérmico

art.	cm.	lt.
44961-03	42x42x34,5	36

With steam release system.
Con sistema di rilascio del vapore.



Insulated container POPTER GN 1/1

Contentitore isotermico
Thermobehälter
Conteneur isotherme
Contenedor isotérmico

art.	cm.	lt.
44987-11	65x50x61	83

For GN 1/1 or submultiples. 12 guides.
Per GN 1/1 o sottomultipli. 12 guide.



Insulated container PORTER MAXI

Contentitore isotermico
Thermobehälter
Conteneur isotherme
Contenedor isotérmico

art.	cm.	lt.
44987-60	72x60x63	128

Guides/Guide: 9



Insulated container GN CRYSTAL

Contentitore isotermico
Thermobehälter
Conteneur isotherme
Contenedor isotérmico

art.	cm.	lt.
44968-00	60x40x30	45,4

Inside crystallized and therefore perfectly smooth, rigid and waterproof.
Interno cristallizzato perfettamente liscio, rigido e impermeabile.



Dolly, aluminum/ABS

Carrello, alluminio/ABS
Fahrgestell, Aluminium/ABS
Chariot, aluminium/ABS
Carro, aluminio/ABS

art.	cm.	for/per
44975C50	58,5x58,5	44975-50
44987C11	68x52	44987-11
44987C60	75x61	44987-60
44987C62	62x42	44968-00



Eutectic pad

Accumulatore di freddo
Kühlakku
Cartouche eutectique
Placa eutéctica

art.	cm.	GN
44979-04	32,5x26,5x3	1/2
44979-05	53x32,5x3	1/1
44979-06	60x40x3	-

0/-21°C.



Heat accumulator

Accumulatore di caldo
Wärmespeicher
Accumulateur de chaleur
Acumulador de calor

art.	cm.	GN
44979-02	53x32,5x3	1/1

0/+85°C.



Insulated box

Box isotermico
Thermobehälter
Conteneur isotherme
Contenedor individual isotérmico

art.	cm.
44976-04	44x38x12

3 sections for dishes ø 12 h 6 cm or 16x16 cm.
3 vani per piatti ø 12 h 6 cm o 16x16 cm.



Insulated box DOMUS

Box isothermico
Thermobehälter
Conteneur isotherme
Contenedor individual isotérmico

art. cm.
44976-02 42,5x26,5x16,5

2 sections for dishes 18x18 cm.
2 vani per piatti 18x18 cm.



Insulated box MONOKING

Box isothermico
Thermobehälter
Conteneur isotherme
Contenedor individual isotérmico

art. cm.
44976-01 42,5x35x16

2 insulated sections for dishes size 18x18 cm.
2 vani coibentati per piatti 18x18 cm.



Insulated box THERMOKING

Box isothermico
Thermobehälter
Conteneur isotherme
Contenedor individual isotérmico

art. cm.
44976-03 47x37x18,5

Release latch lid. Usefull height 11,5 cm.
Coperchio a incastro. Altezza utile 11,5 cm.

MODULAR SYSTEM
SISTEMA MODULARE

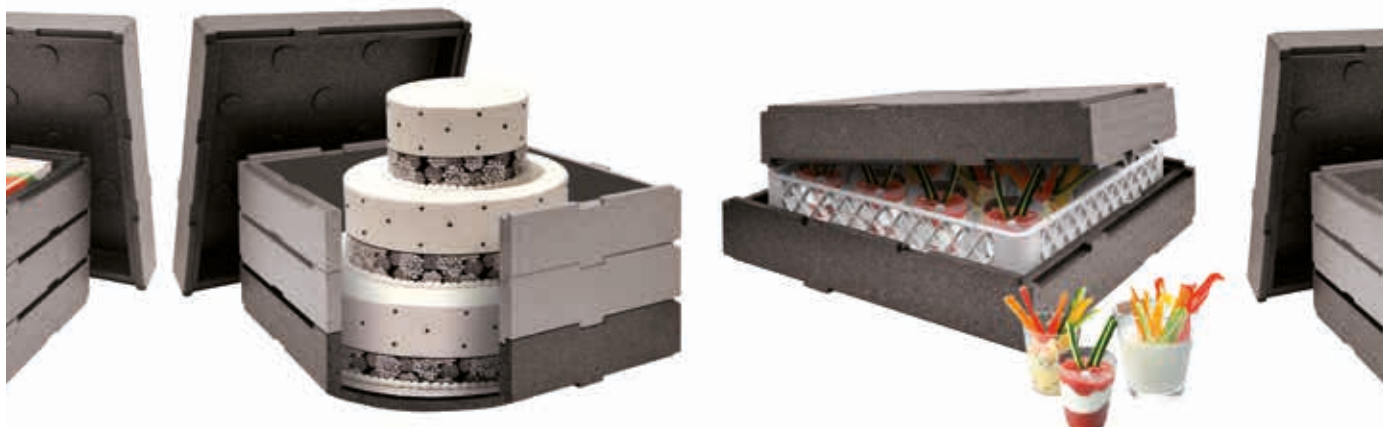

Modular system, the base and lid are the same element and due to the extender insert it is possible to increase capacity.

Sistema modulare, base e coperchio sono lo stesso elemento e grazie all'inserto estensore è possibile aumentare la capacità.

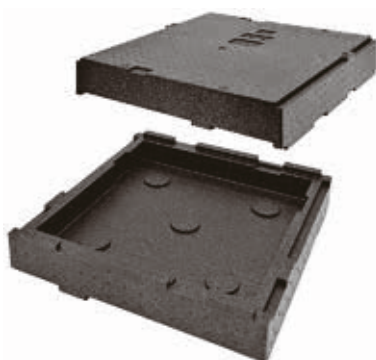

Base and lid

Base e coperchio
Basis und Abdeckung
Base et couvercle
Base y tapa

art. cm.
44975-35 41x41x7,5
44975-50 57x57x10,5



Extender

Estensore
Aufsatz
Réhausse
Extensión

art. cm.
44975H35 41x41x7,5
44975H50 57x57x10,5



SS

Insulated container
 Contenitore isotermico
 Thermobehälter
 Conteneur isotherme
 Contenedor isotérmico

art.	Ø cm.	h. cm.	lt.
44505-10	30	22,5	10
44505-15	36	21,5	15
44505-20	36	28,5	20
44505-25	36	35,0	25



SS

Insulated container
 Contenitore isotermico
 Thermobehälter
 Conteneur isotherme
 Contenedor isotérmico

art.	Ø cm.	h. cm.	lt.
44506-09	30	34	9

Incl. cleaning brush and labels Milk, Coffee and Tea in 5 languages. – Incl. scovolino, etichette Latte, Caffè e Tè in 5 lingue.



SS

Food container
 Pietanziera
 Speisenbehälter
 Porte-manger
 Contenedor comida

art.	Ø cm.	h. cm.
44977-12	12	6



Insulated container GN 1/1
 Contenitore isotermico GN 1/1
 Thermobehälter GN 1/1
 Conteneur isotherme GN 1/1
 Contenedor isotérmico GN 1/1

art.	cm.	lt.
44932-15	61x41x25	24,6
44932-20	61x41x30	31,1

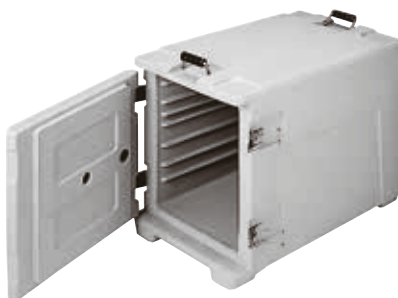

Insulated container GN 1/1
 Contenitore isotermico GN 1/1
 Thermobehälter GN 1/1
 Conteneur isotherme GN 1/1
 Contenedor isotérmico GN 1/1

art.	cm.	lt.
44934-30	44x64x48	63



Insulated beverage dispenser
 Distributore di bevande isotermico
 Isolierte Getränkebehälter
 Conteneur isotherme avec robinet
 Contenedor isotérmico con grifo

art.	cm.	lt.
44930-10	24x43x43	10
44930-20	30x46x46	20



PP

Ice cart
 Carrello porta ghiaccio
 Eiswaagen
 Chariot à glace
 Carro hielo

art.	cm.
44936-57	72x57x85

Load/Carico: 57 kg.



PC

Ice scoop with holder
 Pala ghiaccio con supporto
 Eisschaufel mit Träger
 Pelle à glace avec support
 Librador hielo con soporte

art.	cm.	lt.
44936-02	30,7x20,3x19	2



PC

Ice bucket
 Secchio ghiaccio
 Eiseimer
 Seau à glace
 Cubo hielo

art.	cm.	lt.
44936-20	34x31x45	20,8

JACKSTACK

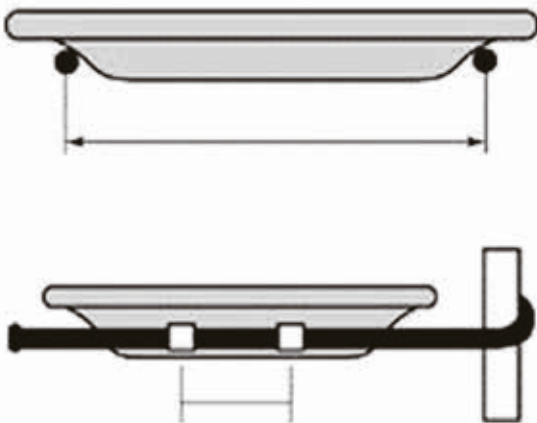

Welded steel construction. Black electrostatic powder coating. Quick set assembly in minutes. Quick-change to any plate size (max ø cm 30, kg 3 each). Length of plate support 17 cm, spacing 5 cm.

Struttura in acciaio saldato. Rivestimento nero elettrostatico. Assemblaggio veloce. Adattabile ad ogni misura di piatto (ø max cm 30, kg 3). Lunghezza bracci 17 cm, distanza 5 cm.



Mobile plate rack
Carrello porta piatti
Fahrbares Tellergerüst
Chariot porte-assiettes mobile
Carrito para almacenaje de platos

art. cm.
44830-99 60x60X179

For pcs/Per pz 104

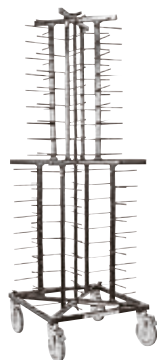

Mobile plate rack
Carrello porta piatti
Fahrbares Tellergerüst
Chariot porte-assiettes mobile
Carrito para almacenaje de platos

art. cm.
44830-72 60x60X179

For pcs/Per pz 72

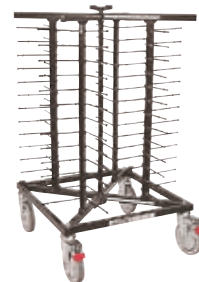

Mobile plate rack
Carrello porta piatti
Fahrbares Tellergerüst
Chariot porte-assiettes mobile
Carrito para almacenaje de platos

art. cm.
44830-52 60x60X103

For pcs/Per pz 52

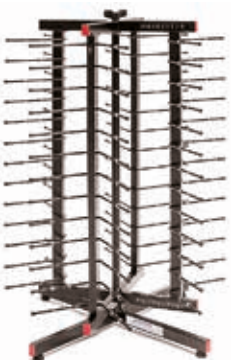

Swivelling table top rack
Porta piatti rotante
Drehbares Tischgerüst
Porte-assiettes de table pivotant
Soporte para almacenaje de platos

art. cm.
44831-52 48x48x89

For pcs/Per pz 52



Zippered plastic cover
Copertura in plastica
Plastik Schutzhülle
Housse en plastique
Cubre carrito, plástico

art. for/per
44832-99 44830-72/44830-99



Thermo cover
Copertura termica
Thermo-Hülle
Thermo-housse
Cubre carrito, térmico

art. for/per
44833-52 44830-52/44831-52
44833-99 44830-72/44830-99



Thermic box

Box termico
Speisen-Kaste
Caisson thermique
Cajón térmico

art.	cm.	W
49990-00	45x46x51	400

Dishes max ø 32 cm. Door opening at 180°, lockable. Intermediate grid shelf. Adjustable thermostat +30°C +90°C. – Piatti max ø 32 cm. Sportello apribile a 180° con chiusura lucchettabile. Ripiano grigliato intermedio. Termostato regolabile +30°C +90°C.



Breakfast-service trolley

Carrello breakfast
Frühstück-Service-Wagen
Chariot petit déjeuner
Carro desayuno

art.	Ø cm.	h. cm.
49991-00	90	78

Water-repellent black MDF top. Swivel castors ø 9,5 cm, 2 with brakes. – Piano in MDF nero idrorepellente. Ruote piroettanti ø 9,5 cm, di cui due con freno.



Trolley with thermic box

Carrello con box termico
Wagen mit Speisen-Kaste
Chariot avec caisson thermique
Carro con cajón térmico

art.	Ø cm.	h. cm.	W
49992-00	90	78	400



Disposable covers, 200 pcs

Coperture monouso, 200 pezzi
Einweg-Schutzhüllen, 200 Stk.
Housses usage unique, 200 pcs
Cubrecajitos desechables, 200 pz

art.	for/per	h. cm.
42512-91	GN 1/1	180
42512-92	GN 2/1	180
	60x40	180



Roll holder

Porta rotolo
Rollenhalter
Dérouleur mural
Portarollos

art.	cm.
42512-90	90x23x19



Utility rack GN 2/1

Carrello GN 2/1
2/1 GN-Behälterwagen
Chariot GN 2/1
Carro GN 2/1

art.	cm.
44807-28	60x70x153,5

Welded structure, 28 rails, 4 wheels, 2 with brakes. – Struttura saldata, 28 guide, 4 ruote girevoli di cui 2 con freno.



Utility rack GN 2/1

Carrello GN 2/1
2/1 GN-Behälterwagen
Chariot GN 2/1
Carro GN 2/1

art.	cm.
44807-36	73x62x171

To be assembled, 18 rails, accomodates GN pans height 65 mm. Load max 300 kg. Fornito smontato, 18 guide, accoglie GN di h. 65 mm. Carico max 300 kg.



Utility rack GN 1/1

Carrello GN 1/1
1/1 GN-Behälterwagen
Chariot GN 1/1
Carro GN 1/1

art.	cm.
44807-18	38x62x164

To be assembled, 18 rails, accomodates GN pans height 65 mm. Load max 150 kg. Fornito smontato, 18 guide, accoglie GN di h. 65 mm. Carico max 150 kg.



Utility rack GN 1/1

Carrello GN 1/1
1/1 GN-Behälterwagen
Chariot GN 1/1
Carro GN 1/1

art.	cm.
44801-09	38x62x94,5

To be assembled, 9 rails, accomodates GN pans height 65 mm. Load max 75 kg. Fornito smontato, 9 guide, accoglie GN di h. 65 mm. Carico max 75 kg.



NEW
SS

Baking sheet trolley

Carrello porta teglie
Backbleche-Wagen
Chariot pour plaques
Carro porta placas

art. cm.
44826-00 52x72x85

Square tube structure 2x2 cm. L-shaped guides, 7,5 cm pitch. For 60x40 cm trays. Stainless steel top. Gray rubber bumpers. Swivel castors ø 9,5 cm, 2 with brakes. – Struttura in tubo quadro 2x2 cm. Guide a "L" passo 7,5 cm. Per teglie cm 60x40. Piano superiore inox. Paracolpi in gomma grigia. Ruote piroettanti ø cm 9,5 di cui 2 con freno.



SS

Serving trolley

Carrello di servizio
Mehrzweckwagen
Chariot de service
Carrito para desocupar

art. cm.
44819-02 91x59x93

To be assembled, 4 swivel castors, 2 with brakes. Load max 80 kg. – Fornito smontato, 4 ruote girevoli di cui 2 con freno. Carico max 80 kg.



SS

Serving trolley

Carrello di servizio
Mehrzweckwagen
Chariot de service
Carrito para desocupar

art. cm.
44819-03 91x59x93

To be assembled, 4 swivel castors, 2 with brakes. Load max 120 kg. – Fornito smontato, 4 ruote girevoli di cui 2 con freno. Carico max 120 kg.



SS

Serving trolley

Carrello di servizio
Mehrzweckwagen
Chariot de service
Carrito para desocupar

art. cm.
44820-80 80x50x93,5
44820-99 100x50x93,5

To be assembled, 4 swivel castors, 2 with brakes. Max load per shelf kg 30. Fornito smontato, 4 ruote girevoli di cui 2 con freno. Portata max. per ripiano kg 30.



SS

Serving trolley

Carrello di servizio
Mehrzweckwagen
Chariot de service
Carrito para desocupar

art. cm.
44822-80 80x50x93,5
44822-99 100x50x93,5

To be assembled, 4 swivel castors, 2 with brakes. Max load per shelf kg 30. Fornito smontato, 4 ruote girevoli di cui 2 con freno. Portata max. per ripiano kg 30.



PP

Serving trolley

Carrello di servizio
Mehrzweckwagen
Chariot de service
Carrito para desocupar

art. cm.
44030-03 42x71x90



PP

Bins and containers

Cesti e contenitori
Kasten und Körbe
Réipients et containers
Cubos y contenedores

art. cm.
44031-04 52x39x12,7
44031-05 52x39x17,7



PE

Container

Contentenore
Kaste
Réipient
Contenedor

art. cm.
44031-01 33,7x23x56
44031-02 33,7x23x18,7



PP

Serving trolley

Carrello di servizio
Mehrzweckwagen
Chariot de service
Carrito para desocupar

art. cm.
49995-04 97x51x99

Load max 135 kg (45 kg per shelf). Carico max 135 kg (45 kg per ripiano).



NEW
SS

Minibar restocking cart

Carrello rifornimento frigobar
Wagen für Minibar-Versorgung
Chariot mini-bar
Carro servicio minibar

art. cm.
44095-30 73x47x102

3 PVC boxes with anti-tip cage for 40 bottles ø 6,5 cm max. Castor wheels ø 12,5 cm, 2 with brakes. – Con 3 cassette in PVC, dotate di gabbia antiribaltamento per 40 bottiglie ø cm 6,5 max. Ruote piroettanti ø cm 12,5 di cui 2 con freno.



NEW

Minibar restocking cart

Carrello rifornimento frigobar
Wagen für Minibar-Versorgung
Chariot mini-bar
Carro servicio minibar

art. cm.
44095-32 100x62x119

Side handle. Key lock. 2 fixed and 2 swivel casters ø 16 cm 2 with brakes. – Maniglia laterale di spinta. Chiusura con chiave. Ruote ø cm 16, di cui due fisse e due piroettanti con freno.



SS

Utility rack GN 2/1

Carrello GN 2/1
2/1 GN-Behälterwagen
Chariot GN 2/1
Carro GN 2/1

art. cm.
44801-18 73x62x94,5

To be assembled, 9 rails, accomodates GN pans height 65 mm. Load max 150 kg.
Fornito smontato, 9 guide, accoglie GN di h. 65 mm. Carico max 150 kg.



SS

Baking sheet trolley

Carrello porta teglie
Backbleche-Wagen
Chariot pour plaques
Carro porta placas

art. cm.
44826-20 69x49x187

20 rails for baking sheets cm 60x40, height clearance 8 cm. Load max 100 kg.
20 guide per teglie cm 60x40, distanza guide 8 cm. Carico max 100 kg.



Baking sheet trolley, galvanized steel

Carrello porta teglie, zincato
Backbleche-Wagen, verzinkt
Chariot pour plaques, galvanisé
Carro porta placas, galvanizado

art. cm.
44825-20 51x50x170

20 rails, height clearance 8 cm. Load max. 80 kg.
20 guide, distanza guide 8 cm. Carico max 80 kg.

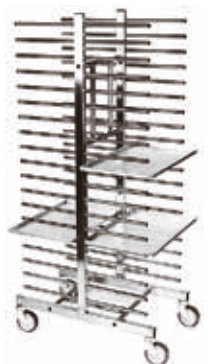

Baking sheet trolley, galvanized steel

Carrello porta teglie, zincato
Backbleche-Wagen, verzinkt
Chariot pour plaques, galvanisé
Carro porta placas, galvanizado

art. cm.
44825-40 51x75x170

40 rails, height clearance 8 cm. Load max 160 kg. – 40 guide, distanza guide 8 cm. Carico max 160 kg.



SS

Dolly for cases

Carrello porta cassette
Plattformwagen
Chariot à caisses
Carretilla de transporte

art. cm.
44026-60 65x45x12

Load max 50 kg. – Carico max 50 kg.



PE

Platform cart

Carrello trasporto materiali
Plattformwagen
Chariot de transport
Plataforma móvil

art. cm.
49378-00 82,6x52x98,7

Three position handle ensures optimum handling whatever the load. Non slip deck, 2 swivel and 2 rigid castors. Load 181 kg.
Maniglia regolabile in 3 posizioni. Superficie antiscivolo. 2 ruote fisse, 2 piroettanti. Carico 181 kg.



PP

Trolley, convertible
Carrello convertibile
Plattformwagen, umwandelbar
Chariot convertible
Carretilla convertible

art. cm.
49379-00 56x53x43,5

Four non-marking casters (two rear locking), 2 swivel and 2 rigid. – Ruote antitraccia di cui 2 fisse e 2 girevoli, ruote posteriori bloccabili.



CLEANING PULIZIA

STORAGE & TRANSPORT
STOCCAGGIO E TRASPORTO





PP

Changing table

Fasciatoio da parete
Windeln-Tisch
Table à langer
Mesa cambia-pañales

art. cm.

49336-00 91x71x49,6

49336-02 60x88x48

Rated for continuous use up to 23 kg. – Portata max in uso 23 kg.



PP

Sturdy chair

Seggiolone
Kinderstuhl
Chaise d'enfant
Silla niños

art. cm.

49337-00 60x60x75,5

49337-01 29x47x8,3

For children up to 3 years old or 18 kg weight. With Microban antimicrobial protection. – Adatto a bambini fino a 3 anni o 18 kg di peso. Con protezione antibatterica in Microban.



NEW

W

Sturdy chair

Seggiolone
Kinderstuhl
Chaise d'enfant
Silla niños

art. cm. col.

49335-01 50x50x75

49335-02 50x50x75

Suitable for children from 6 months to 3 years. Max. 20 kg. Adatto ai bambini da 6 mesi a 3 anni. Fino a 20 kg.



Trolley Quick Cart

Carrello Quick Cart
Quick Cart-Wagen
Chariot Quick Cart
Carretilla Quick Cart

art. cm. Kg. cap. m3

44178-01 42x36x43 6,5 0,05

44178-02 42x36x53 7,0 0,06

Versatile compartments allow for multiple configurations and uses. Removable caddy. Adjustable dividers. Teflon fabric protector, repels water, oil and stains. Reinforced rubberised kick plate. – Scomparti versatili consentono molteplici configurazioni e usi. Cestello estraibile. Divisori removibili. Rivestimento in Teflon, respinge acqua, olio e macchie. Scocca rinforzata in gomma.



Collapsible frame, powder coated steel

Telaio pieghevole, acciaio verniciato
Klappbares Gestell, pulverbeschichtete Stahl
Châssis repliable, acier peint
Carre plegable, acero pintado

art. cm. lt.

44178-15 51,5x61x84 150

44178-16 89x61x84 300

Collapsible frame enables efficient storage. Compact, lightweight design for superior manoeuvrability. Remains collapsible with or without cover. – Telaio pieghevole consente uno stoccaggio efficiente. Design compatto e leggero per una maggiore manovrabilità. Rimane pieghevole con o senza copertura.



Vinyl bag, black

Sacco vinile, nero
Vinyl-Sack, schwarz
Sac en vinyle, noir
Bolsa de vinilo, negro

art.	cm.	lt.
44178-17	39x57x69	150
44178-18	78x57x69	300

Durable, high capacity (100 kg) vinyl bag accommodates large loads; easy-to-clean. – Sacchi in vinile durevoli, ad alta capacità (100 kg); facili da pulire.



Vinyl bag cover, black

Copertura vinile, nero
Vinyl-Sack-deckel, schwarz
Couvercle à sac en vinyle, noir
Tapa para bolsa de vinilo, negro

art.	cm.
44178-19	64x50x23
44178-20	89x66x23

Multiple, built-in storage pockets on each side. Convenient, Quick-Access-Lid provides easy access to contents inside of cart without having to remove cover. – Con tasche integrate su ogni lato. Comodo, accesso rapido all'interno del carrello, senza dover rimuovere il coperchio.



NEW

SS

Service trolley

Carrello servizio
Servierwagen
Chariot de service
Carro de servicio

art.	cm.
44096-01	120x52x137

Stainless steel square tube structure 2x2 cm. Mdf cherry wood tops. 2 folding bag holders with linen laundry bag. Gray rubber bumpers. Castor wheels ø 12.5 cm. – "Struttura in tubo quadro inox 2x2 cm. Piani in nobilitato color ciliegio. 2 reggisacco pieghevoli con sacco portabiancheria in tela. Paracolpi in gomma grigia. Ruote piroettanti ø 12,5 cm.



NEW

SS

Service trolley

Carrello servizio
Servierwagen
Chariot de service
Carro de servicio

art.	cm.
44096-02	119x52x134

Stainless steel square tube structure 2x2 cm. Mdf cherry tops and panels. Folding bag holder with linen laundry bag. Base with perimeter bumper in gray non-marking rubber. Castor wheels ø 15 cm. – Struttura in tubo quadro inox 2x2 cm. Piani e pannelli in nobilitato color ciliegio. Reggisacco pieghevole con sacco portabiancheria in tela. Base con paracolpi perimetrale in gomma grigia antitraccia. Ruote piroettanti ø 15 cm.



NEW

SS

Service trolley

Carrello servizio
Servierwagen
Chariot de service
Carro de servicio

art.	cm.
44096-03	139x52x134

Stainless steel square tube structure 2x2 cm. Mdf cherry tops and panels. Folding bag holder with linen laundry bag. Base with perimeter bumper in gray non-marking rubber. Castor wheels ø 15 cm. – Struttura in tubo quadro inox 2x2 cm. Piani e pannelli in nobilitato color ciliegio. Reggisacco pieghevole con sacco portabiancheria in tela. Base con paracolpi perimetrale in gomma grigia antitraccia. Ruote piroettanti ø 15 cm.



PP

Service trolley

Carrello di servizio
Servicewagen
Chariot de service
Carro de habitaciones

art.	cm.	lt.	Kg.
44174-24	177x58x107	120+120	26,4

"Wheels ø125 mm, 2 bag holders + 2 bags lt. 120. Made in polypropylene copolymer." – "Ruote ø125 mm, 2 portasacco pieghevoli + 2 sacco lt. 120. Prodotto in polipropilene copolimero."



PP

Service trolley

Carrello di servizio
Servicewagen
Chariot de service
Carro de habitaciones

art.	cm.	lt.	Kg.
44177-12	104x56x130	150	26

Frame in tubular steel ø 22 mm, Rilsan coated. Wheels ø 125 mm. 3 wooden shelves 50x46 cm. Bag holder + canvas bag polyester cm. 55x55x94.
Montanti in tubolare inox ø 22 mm, verniciato Rilsan. Ruote ø 125 mm. 3 ripiani legno 50x46 cm. Portasacco+sacco in tela poliestere cm. 55x55x94.



PP

Housekeeping cart for linen collection

Carrello portabiancheria
Hotelwäschewagen
Chariot d'étage à linge
Carro de recogida de ropa

art.	cm.	lt.	Kg.
44176-30	105x55x105	300	12,5

Tubular frame ø 22 mm, Rilsan coated steel. Wheels ø 125 mm. Bag, nylon 210. – Montanti in tubolare inox ø 22 mm, verniciato Rilsan. Ruote ø 125 mm. Sacco in nylon 210 plastificato.



Housekeeping cart for linen collection

Carrello portabiancheria
Hotelwäschewagen
Chariot d'étage à linge
Carro de recogida de ropa

art.	cm.	lt.	Kg.
44175-15	62x60x103	150	6,39

Capacious canvas bag laminated washable at 30°. Folding frame. Swivel casters ø 80 mm.
Capiente sacco in tela plasticata lavabile a 30°. Telaio pieghevole. Ruote piroettanti ø 80 mm.



Cleaning system, Pulse

Sistema di pulizia, kit Pulse
Reinigungssystem Pulse
Système de nettoyage Pulse
Sistema de limpieza Pulse

art.	cm.
44151-00	12,4x9,5x142

Aluminum frame 40 cm and 2 microfibre mops.
On-board reservoir 700 ml that allows to clean up to 80 sqm.
Telaio in alluminio con velcro da 40 cm, 2 mop in microfibra. Dotato di deposito integrato da 700 ml che permette di pulire fino a 80 mq.



Microfibre mops

Mop in microfibra
Microfiber-Mops
Franges en microfibra
Fregadoras de microfibra

art.	cm.	des.	U. Pack
44151-AA	40x14	Wet	10
44151-AB	40x14	High absorb	10
44151-AC	40x14	Scrubber	10

Wet use, high absorbency, for 80 sqm. Launderable up to 500 times (200 with bleach) at high water temperature. – Uso umido ad elevata assorbenza 80 mq. Ciclo di vita: 500 lavaggi (200 con candeggina) ad elevate temperature.



Dust beater "V" sweeper complete

Scopa a forbice completa
Doppel-Wischnop
Balai double mop
Escoba doble

art.	h. cm.
44160-03	135

Opening angle 140° about. Cotton mops length 100 cm. – Apertura 140° circa. Frange in cotone 100 cm.



Mechanical sweeper

Aspirapolvere meccanico
Kehrer mit mechanischem Antrieb
Balai mécanique
Escoba mecánica

art.	cm.	lt.
44150-19	28,5x25x102	0,6

ABS and galvanised steel construction. Ideal for hard floors and low pile carpets. Sweeping path 19 cm. – ABS e acciaio galvanizzato. Ideale sia per tappeti/moquette a pelo corto che per pavimenti. Battuta 19 cm.



Broom + dust pan

Scopa + alza immondizia
Kehrset mit Stiel und Schmutzcontainer
Balai + pelle
Escoba + recogedor

art.	cm.
44149-03	28,6x13x32,5

Self opening and closing lid. Broom hanger bracket. – Porta immondizia con coperchio. Staffa di supporto per scopa.

PP



Dustpan

Paletta manico lungo
Müllschaufel
Pelle à poussière
Pala

art. 44170-00



Broom, aluminum rod

Scopa, manico alluminio
Besen mit Alustiel
Balai, manche alu
Escoba, mango alumimio

art. 44170-01 h. cm. 80



Cleaning wand

Scopa spingiacqua
Abzieher
Balai raclette
Escoba

art. 44148-01 cm. 116,8x40

Blade made of soft double mass squeegee foam supported by a galvanized metal frame.

Testa della scopa realizzata in morbida gommaspugna a doppio strato sostenuta da telaio in metallo galvanizzato.



Wet mop handles

Manico per mop
Nassmopp-Stiele
Supports pour franges
Mangos para fregonas

art.	cm.	col.
44141-01	152,4	●
44141-03	152,4	●

Polypropylene/Glass fiber.
Polipropilene/fibra di vetro.



Cotton-end string mop

Mop a strisce in cotone
Spaghetti-Mop mit Baumwollenen
Fränge à ficelles en coton
Mopa de algodón

art. 44142-40 gr. 400



Cotton mop rod, screw fitting

Manico per mop, attacco filettato
Mop-Stange mit Schraubanschluss
Manche pour mop avec attache à vis
Mango para fregadora, conexión tornillo

art.	Ø cm.	cm.
44167-13	2,2	130

Red lacquered iron. Lightweight and rustproof.
Ferro verniciato rosso. Leggero ed inossidabile.



Cotton mop, screw fitting

Mop in cotone, attacco filettato
Baumwollmop mit Schraubanschluss
Mop en coton avec attache à vis
Mopa de algodón

art.	gr.
44166-28	280



Telescopic rod

Manico telescopico
Teleskopstange
Manche telescopique
Mango telescópico

art.	Ø cm.	cm.
44161-00	2,3	97>184

Two-piece anodized aluminum rod.
Alluminio anodizzato due pezzi.



Mop holder

Pinza per mop
Wischnophalter
Pince faubert
Pinza

art. 44164-00

Universal ring allows the use of any handle with from ø 20 to 24 mm. – Ghiera universale consente l'utilizzo di qualsiasi manico con ø 20>24 mm.



Cotton-end string mop

Mop a strisce in cotone
Spaghetti-Mop mit Baumwollend
Frange à ficelles en coton
Mopa de algodón

art.	gr.
44165-35	350
44165-40	400
44165-50	500



Microfibre cloth, 12 pcs

Panno in microfibra, 12 pz
Mikrofasertuch, 12 Stk
Carré en microfibra, 12 pcs
Paño de microfibra, 12 pz

art.	cm.	col.
44147-00	40,6x40,6	●
44147-01	40,6x40,6	●
44147-02	40,6x40,6	●
44147-03	40,6x40,6	●

Launderable up to 100 times with bleach and 250 without bleach. – Dura 100 lavaggi con candeggina e 250 senza.



2-sided floor sign

Cavalletto di segnalazione a 2 lati
2-seitig, Warnschild
Panneau d'avertissement 2 côtés
Señal de suelo 2 lados

art.	h. cm.
44077-00	57
44077-CC	67

PP



Multi-purpose trolley

Carrello multiuso
Allzweckwagen
Chariot multi-usage
Carro de limpieza

art.	cm.
44173-00	97x68x111

Bag holder with cover, bag lt. 120, pan with hooks, 2 buckets 4 lt. and 2 buckets 15 lt., wringer. – Portasacco con cop., sacco lt. 120, vaschetta con ganci, 2 secchi 4 lt., 2 secchi 15 lt., strizzatore.

PP



Mopping trolley with press

Carrello lavapavimenti con strizzatore
Wringer Reinigungswagen mit Presse
Chariot de ménage avec presse
Carro con prensa escurridora

art.	cm.
44171-24	62x42x90

Wringer and 25 lt. bucket. With storage compartment. PSV reinforced handle. Strizzatore e 1 secchio lt. 25. Vano portaoggetti. Impugnatura in PSV completa di rinforzi.

PP



Mopping trolley with press

Carrello lavapavimenti con strizzatore
Wringer Reinigungswagen mit Presse
Chariot de ménage avec presse
Carro con prensa escurridora

art.	cm.
44171-50	69x42x90

Wringer and 2 buckets lt. 25 each. Painted handle, reversible. – Strizzatore e 2 secchi da lt. 25. Impugnatura verniciata, reversibile.

PP



Mopping trolley with press

Carrello lavapavimenti con strizzatore
Wringer Reinigungswagen mit Presse
Chariot de ménage avec presse
Carro con prensa escurridora

art.	cm.
44172-30	47x40x93

Single tank with wringer. Monovasca con strizzatore.

PP



Graduated bucket

Secchio graduato
Eimer mit Skala
Seau gradué
Cubo con medidas

art.	cm.	lt.	col.
44169B06	24x19x21,5	6	●
44169R06	24x19x21,5	6	●

PP



Graduated bucket

Secchio graduato
Eimer mit Skala
Seau gradué
Cubo con medidas

art.	cm.	lt.	col.
44169B14	34x33,5x28	15	●
44169R25	37x36,5x32	25	●

PP



PP

Bucket with wringer
Secchio con strizzatore
Eimer mit Presse
Seau avec essoreur
Cubo con prensa

art.	cm.	lt.
44168-12	35x27x29,5	12

With graduated scale 0-12 lt.
Scala graduata 0-12 lt.



PP

Waste container
Cestino
Abfallbehälter
Collecteur
Papelera

art.	Ø cm.	h. cm.
44097-00	30	32



NEW

PE

Step on bin
Pattumiera a pedale
Pedaleimer
Poubelle à pédale
Colector a pedal

art.	cm.	lt.
49935-45	41x40x60	45
49935-68	50x41x37	68
49935-87	50x41x82,5	87



PE

Step on bin
Pattumiera a pedale
Pedaleimer
Poubelle à pédale
Colector a pedal

art.	cm.	lt.
49933-30	50x31x56,5	30
49933-50	53x34x72	50
49933-68	56x37x78	68



Waste container SLIM JIM
Contenitore rifiuti
Abfallbehälter
Collecteur
Colector

art.	cm.	lt.
49931-60	59x28x63	60
49931-87	56x28x76	87



PP

Lid
Coperchio
Deckel
Couvercle
Tapa

art.	cm.	col.
49931A00	52x29x7	●
49931C04	52x29x7	●
49931B05	52x29x7	●
49931B02	52x29x7	●
49931B03	52x29x7	●
49931B01	52x29x7	●



PP

Hinged lid
Coperchio ancorato
Klapp-Deckel
Couvercle à charnière
Tapa abatible

art.	cm.
49931-00	55,6x34x3





PP

Dolly SLIM JIM

Carrello
Transportwagen
Chariot
Carrito

art. cm.
49931-64 60,6x37,4X21

Side clip allows to tow together more trolleysdal release fast and simple. – Aggancio laterale a clip che permette di trainare insieme diversi carrelli. Rilascio a pedale semplice e veloce.



NEW

PE

Recycling station starter kit

Kit stazione di riciclo
Recyclingstation Starterkit
Kit station de recyclage
Kit estación de reciclaje

art. cm.
49936-10 54,6x30,5x87

Container, lid, connector.
Base, coperchio, connettore.



NEW

PP

Lid

Coperchio
Deckel
Couvercle
Tapa

art. cm. col.
49936N11 41,9x20,3x1,3 ●
49936G11 41,9x20,3x1,3 ●
49936M11 41,9x20,3x1,3 ●



NEW

PP

Mixed recycling lid

Coperchio riciclaggio misto
Gemischter Recyclingdeckel
Couvercle de recyclage mixte
Tapa de reciclaje mixta

art. cm. col.
49936B11 41,9x20,3x1,3 ●
49936R11 41,9x20,3x1,3 ●
49936Y11 41,9x20,3x1,3 ●
49936V11 41,9x20,3x1,3 ●



NEW

PP

Billboard

Cartello
Tafel
Panneau
Cartelera

art. cm. col.
49936B12 36,2x29,8x4,4 ●
49936R12 36,2x29,8x4,4 ●
49936Y12 36,2x29,8x4,4 ●
49936V12 36,2x29,8x4,4 ●



NEW
PP

Billboard
Cartello
Tafel
Panneau
Cartelera

art.	cm.	col.
49936N12	36,2x29,8x4,4	●
49936G12	36,2x29,8x4,4	●
49936M12	36,2x29,8x4,4	●



NEW
PP

Label kit
Kit etichette
Etikettenkit
Kit étiquettes
Kit de etiquetas

art.	des.
49936-13	English
49936-14	Italiano
49936-15	Deutsch
49936-16	Français
49936-17	Español

10x1 adhesive for each type of waste.
10x1 adesivo per ogni tipo di flusso rifiuti.



PE

Mobile pedal bin
Pattumiera a pedale
Pedaleimer
Poubelle à pédale
Colector a pedal

art.	cm.	lt.
44095-12	48x55x93	120

Certified UNI EN 840. Withstanding chemical, can be washed and sterilized.
Certificata UNI EN 840. Resistente agli agenti chimici, lavabile e sterilizzabile.



PP

Mobile bin
Pattumiera a pedale
Pedaleimer
Poubelle à pédale
Colector a pedal

art.	cm.	lt.
44095-18	40x65x81	80



PP

Mobile pedal bin
Pattumiera a pedale
Pedaleimer
Poubelle à pédale
Colector a pedal

art.	cm.	lt.	col.
44096-80	48x50x78	80	○
44096B80	48x50x78	80	●
44096Y80	48x50x78	80	●
44096R80	48x50x78	80	●
44096G80	48x50x78	80	●



Pedal bin lids
Coperchi pattumiera
Pedaleimer-Deckel
Couverts poubelle
Tapas para colector

art.	cm.	col.
49899-91	46x32	●
49899-92	46x32	●
49899-93	46x32	●
49899-94	46x32	●
49899-95	46x32	●



PP

Mobile pedal bin, fire-proof
Pattumiera a pedale, ignifuga
Pedaleimer, feuersicher
Poubelle à pédale, ignifugée
Colector a pedal, ignifugo

art.	cm.	lt.	col.
49899-01	46x32x80	70	●

Mechanical parts in stainless steel. The lid can be removed. – Parti meccaniche in acciaio inox. Coperchio staccabile.



Refuse bag holder trolley
Carrello portasacco
Sackhalterwagen
Chariot porte-sac
Colector móvil

art.	cm.	lt.
44089-12	58x56x102	120



PE

Tilt truck

Benna ribaltabile
Falten Eimerwagen
Benne
Carrito plegable

art.	cm.	lt.	Kg.
49934-04	145x68x86	400	205
49934-06	164x77x97	600	272
49934-08	180x85x107	800	570



PE

Domed linged lid

Coperchio a doppia apertura
Doppel-Deckel
Couverture double
Tapa doble

art.	cm.
49934-14	132x71x23
49934-16	155x81x23
49934-18	169x87x23



PP

Folding ladder

Scaletta pieghevole
Klappleiter
Marche-pied pliable
Escalera plegable

art.	cm.
49378-48	48,6x17x63

Load 150 kg. Resists from 0 to 50 °C.
Carico 150 kg. Resiste da 0 a 50°C.



PE

Pallet

Pallet
Pallet
Palette
Racks para suelos

art.	cm.	Kg.
49373-05	80x120x14	4,6

Static load 1000 kg. Appropriate for food.
Carico statico 1000 kg. Per uso alimentare.



Dunnage rack

Pedana
Lageruntersätze
Palettes
Bancada

art.	cm.	load kg
49371-09	91,4x56x30,5	68
49371-12	122x56x30,5	136

Rust and corrosion-proof polymer material.
Materiale polimerico resistente alla ruggine e alla corrosione.



SS

Floor standing ashtray

Posacenere a colonna
Standascher/Abfalleimer
Cendrier sur pied
Contenedor con cenicero

art.	Ø cm.	h. cm.
49897-09	9	86



SS

Standing ashtray/bin

Posacenere/pattumiera
Standascher/Abfalleimer
Cendrier/poubelle
Cenicero/papelera

art.	Ø cm.	h. cm.
49898-30	30	60



PP

Standing ashtray

Posacenere/fioriera
Standascher
Cendrier sur pied
Cenicero

art.	Ø cm.	h. cm.
49892-40	40	60

Included bag of sand 1,5 kg.
Incl. sacchetto sabbia kg 1,5.

ELECTRIC APPLIANCES APPARECCHI ELETTRICI





Dualit.

4 slot toaster

Tostapane 4 fette
Brotröster
Grille pain
Tostadora

art.	cm.	Kg.	kW
49801-04	36x21x22	4,25	2,2



Dualit.

6 slot toaster

Tostapane 6 fette
Brotröster
Grille pain
Tostadora

art.	cm.	Kg.	kW
49801-06	46x21x22	5,1	3



Dualit.

4 slice bun toaster

Tostapane 4 fette
Brotröster
Grille pain
Tostadora

art.	cm.	Kg.	kW
49802-04	36x21x22	4,52	1



Dualit.

6 slice bun toaster

Tostapane 6 fette
Brotröster
Grille pain
Tostadora

art.	cm.	Kg.	kW
49802-06	46x21x22	5,52	1,5



Conveyor Toaster

Tostapane a nastro
Durchlauf-Toaster
Toaster convoyeur
Tostador a túnel

art.	cm.	Kg.	kW
49803-02	37x64x40	20	2,8



Conveyor toaster, CT540 B

Tostapane a nastro doppia uscita
Durchlauf toaster
Toaster convoyeur
Tostador a túnel

art.	cm.	Kg.	kW
49850-20	50x68x34,5	20	2,65



Toaster, BAR 1000

Tostapane
Toast-/Überbackgerät
Toaster
Tostador de pan

art.	cm.	Kg.	kW
49850-65	45x28,5x30,5	10	2



Toaster, BAR 2000

Tostapane
Toast-/Überbackgerät
Toaster
Tostador de pan

art.	cm.	Kg.	kW
49850-66	45x28,5x42	12	3

**Contact grill, SAVOYE**

Grill a contatto
 Kontaktgrill
 Grill à contact
 Grill de contacto

art.	cm.	Kg.	kW
49850-22	33x38,5x22	18	2

**Contact grill, PANINI**

Grill a contatto
 Kontaktgrill
 Grill à contact
 Grill de contacto

art.	cm.	Kg.	kW
49850-21	43x38,5x22	22,5	3

**Contact grill double plate, MAJESTIC**

Grill a contatto doppia piastra
 Kontaktgrill, 2 Platten
 Grill à contact, 2 plaques
 Grill de contacto doble

art.	cm.	Kg.	kW
49850-23	60x38,5x22	33,5	2x2

**Contact sandwich toaster**

Grill a contatto
 Sandwich-Toaster
 Appareil croque monsieur
 Grill de contacto

art.	cm.	Kg.	kW
49806-00	40x22x19	6	1,6

Dualit.**Contact grill, PANINI XL**

Grill a contatto
 Kontaktgrill
 Grill à contact
 Grill de contacto

art.	cm.	Kg.	kW
49850-19	41x62x34	32	3,6

**Glas ceramic contact grill, GVS 335**

Grill a contatto vetroceramica
 Kontaktgrill, Glaskeramik-Platte
 Grill à contact vitroc ramique
 Grill de contacto vitrocer mica

art.	cm.	Kg.	kW
49850-18	39x60x26	14	3



Glass ceramic griddle plate, PS 400 VC

Piastra in vetroceramica
Glaskermik-Grillplatte
Plaque à snacker vitroc ramique
Plancha hasadora vitrocer mica

art.	cm.	Kg.	kW
49850-60	39x42x15	7	1,5



Salamander, SEM 600 PDS

Salamandra
Salamanders mit PDS
Salamandre avec d tection de plat
Salamandra con PDS

art.	cm.	Kg.	kW
49850-71	60x64x59	56	3



Kebab/Gyros grill, GR 40 E

Griglia kebab/gyros
Elektro-D nergrill
Gril   kebab/gyros
Asador de kebab/gyros

art.	cm.	Kg.	kW
49850-13	58x66x69,5	15	3,6



Kebab/Gyros grill, GR 60 E

Griglia kebab/gyros
Elektro-D nergrill
Gril   kebab/gyros
Asador de kebab/gyros

art.	cm.	Kg.	kW
49850-14	58x66x87	25	5,8



Hot dog heater, CS 3 E

Scalda w rstel
W rstchenw rmer
Chauffe-saucisses
Calentador de salchichas

art.	cm.	Kg.	kW
49850-61	44x30x40	9	0,65



Crepe machine, high-capacity, CFE 400

Crepiera tonda, ad alto rendimento
Cr peger t
Cr pi re   haut rendement
Crepera

art.	� cm.	h. cm.	Kg.	kW
49850-33	40	20	18	3,6

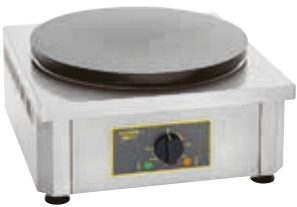

Double crepe machine, CDE 400

Crepiera doppia
Crêpegerät, 2 Platten
Crêpière double
Crepera 2 placas

art.	Ø cm.	cm.	Kg.	kW
49850-11	40	45x50x24	23	3,6



Single crepe machine, CSE 400

Crepiera singola
Crêpegerät
Crêpière simple
Crepera

art.	Ø cm.	cm.	Kg.	kW
49850-12	40	86x50x24	44	3,6x2



Eggs boiler, CO 60

Bollitore uova
Eierkocher
Cuiseur à oeuf
Caldera para huevos

art.	cm.	Kg.	kW
49850-36	21,5x43x25,5	4,5	1,2



Multifunction oven, FC 280

Forno multifunzione
Multifunktionsofen
Four multifonctions
Horno multifunción

art.	cm.	Kg.	kW
49850-73	46x55x35,5	20	1,5



Multifunction oven, FC 380 TQ

Forno multifunzione
Multifunktionsofen
Four multifonctions
Horno multifunción

art.	cm.	Kg.	kW
49850-75	55x55x35,5	22	2,4



Multifunction oven, FC 60 TQ

Forno multifunzione
Multifunktionsofen
Four multifonctions
Horno multifunción

art.	cm.	Kg.	kW
49850-76	59,5x61x59	38	3



Fryer, FD 80 R

Friggitrice
Fritteuse
Friteuse
Freidora

art.	cm.	kg./H	Kg.	kW
49850-41	26,5x45x36	15	8	3,6

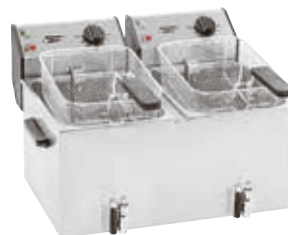

Fryer, FD 80 DR

Friggitrice
Fritteuse
Friteuse
Freidora

art.	cm.	kg./H	Kg.	kW
49850-42	59x45x37	30	15	2x3,6



Fryer, FD 50

Friggitrice
Fritteuse
Friteuse
Freidora

art.	cm.	kg./H	Kg.	kW
49850-37	21,5x42,5x32	10	5	3,2



Fryer, FD 50 D

Friggitrice
Fritteuse
Friteuse
Freidora

art.	cm.	kg./H	Kg.	kW
49850-39	39x42,5x32	20	10	2x3,2



Dish-warmer, DW106 / 110

Scaldapiatti
Rechaud
Chauffe plats
Calentador de platos

art.	cm.	Kg.	kW
49850-06	40x21,5x33,5	14	0,65
49850-10	40x21,5x47,5	25	1,3



Ventilated warming display, WD 780 SI

Espositore caldo ventilato
Konvektion-Warme Theke
Présentoir chaud à convection
Expositor caliente con convección

art.	cm.	Kg.	kW
49850-69	78x49x48	30	1,2



Ventilated warming display, WD 780 DI

Espositore caldo ventilato
Konvektion-Warme Theke
Présentoir chaud à convection
Expositor caliente con convección

art.	cm.	Kg.	kW
49850-70	78x49x64	35	1,8



Warming display

Vetrina riscaldata
Warmhalte-Vitrine
Vitrine chauffante
Vitrina caliente

art.	GN	cm.	Kg.	kW	range
49850-43	1/1	59x35x28,5	12	0,65	+20 +95°C



Warming display

Vetrina riscaldata
Warmhalte-Vitrine
Vitrine chauffante
Vitrina caliente

art.	GN	cm.	Kg.	kW	range
49850-44	2x 1/1	59x35x39	15	0,65	+20 +95°C



Tapas display

Vetrina antipasti
Vorspeisen-Schaufenster
Vitrine tapas
Vitrina para tapas

art.	cm.	Kg.	W	range
49630-06	145x40x26	33	160	+2/+5°C
49630-08	180x40x26	40	160	+2/+5°C



Ice cream maker

Macchina per gelato
Eismaschine
Machine à glace
Maquinas helado

art.	cm.	lt.	kg./H	Kg.	kW
49949-19	51x31x35	1,5	3	30	0,4



Dehydrator for fruits and vegetables

Disidratatore per frutta e verdura
Dehydratisierapparat
Déshydrateur fruits et légumes
Deshidratador de frutas y verduras

art.	cm.	Kg.	kW	range
49953-02	43,5x29x21	3,6	0,53	+30 +80°C

Supplied with 6 reversible trays. Timer up to 72 hours.
6 vassoi reversibili. Timer fino a 72 ore.



Smoker, 2 levels

Affumicatoio a 2 piani
Räucherofen
Fumoir
Ahumador

art.	cm.	Kg.	kW
49850-63	45x45x35	25	1,5



Table-top cutter

Cutter da tavolo
Gemüeschneidmaschine
Cutter à légumes
Cortador verduras

art.	cm.	lt.	Kg.
49979-03	32x52x62	3	12



Waffle iron

Macchina per cialde
Waffeleisen
Gufrier
Gofrera

art.	cm.	Kg.	kW
49809-00	40x22x19	5,5	1,6

Dualit.





Single waffle iron, GESIMPLE

Macchina per cialde
Waffeleisen mit 1 Platte
Gaufrier simple
Gofrera singular

art.	cm.	Kg.	kW
49850-24	30,5x44x23	22	1,6
49850-25	30,5x44x23	22	1,6
49850-26	30,5x44x23	22	1,6
49850-27	30,5x44x23	22	1,6



Double waffle iron, GESDOUBLE

Macchina per cialde doppia
Waffeleisen mit 2 Platten
Gaufrier double
Gofrera doble

art.	cm.	Kg.	kW
49850-28	55x44x23	38	3,2
49850-29	55x44x23	38	3,2
49850-30	55x44x23	38	3,2
49850-31	55x44x23	38	3,2



-24 / -28



-25 / -29



-26 / -30



-27 / -31



Single waffle iron, GES23

Macchina per cialde
Waffeleisen mit 1 Platte
Gaufrier simple
Gofrera singular

art.	cm.	Kg.	kW
49850-03	30,5x44x23	22	1,6





NEW
SS

Infrared lamp with warming plate

Lampada ad infrarossi con piano caldo
Infrarot Wärmebrücke mit Wärmeplatte
Lampe infrarouge avec plaque chauffante
Lámpara infrarrojos y placa caliente

art.	GN	cm.	kW
49993-21	1/1	38x53x70	0,5
49993-22	2/1	70x53x71	1,0
49993-23	3/1	103x53x70	1,5

Curved plexiglass fender. Separate switches for plate and lamps. Adjustable thermostat +30°C +90°C. – Parafiatto in plexiglass curvo. Interruttori di accensione separati per piano caldo e lampade. Termostato regolabile +30°C +90°C.



NEW
SS

Infrared lamp

Lampada ad infrarossi
Infrarot Wärmebrücke
Lampe infrarouge
Lámpara infrarrojos

art.	GN	cm.	kW
49993-01	1/1	38x53x70	0,25
49993-02	2/1	70x53x71	0,50
49993-03	3/1	103x53x70	0,75

Curved plexiglass fender. – Parafiatto in plexiglass curvo.



NEW
SS

Warming plate

Piano caldo
Wärmeplatte
Plaque chauffante
Placa caliente

art.	GN	cm.	kW
49993-11	1/1	33x53x6	0,25
49993-12	2/1	66x53x6	0,50
49993-13	3/1	132x53x6	0,75

Adjustable thermostat +30°C +90°C. – Termostato regolabile +30°C +90°C.



NEW
SS

Thermic box

Box termico
Speisen-Kaste
Caisson thermique
Cajón térmico

art.	cm.	kW
49990-00	45x46x51	0,4

For dishes max diameter 32 cm. PVC handle. Hinged door, opening at 180°. Opening handle with lockable snap closure. Intermediate grid shelf. Adjustable thermostat +30°C +90°C.

Piatti diametro max 32 cm. Maniglia in PVC. Sportello a battente, apribile a 180°. Maniglia di apertura con chiusura a scatto lucchettabile. Ripiano grigliato intermedio. Termostato regolabile +30°C +90°C.



NEW
SS

Trolley with thermic box

Carrello con box termico
Wagen mit Speisen-Kaste
Chariot avec caisson thermique
Carro con cajón térmico

art.	Ø cm.	h. cm.	kW
49992-00	90	78	0,4

Water-repellent black MDF top, folding side flaps. Possibility to rotate the table at 90° and allow stacking. Swivel castors ø 9,5 cm, 2 with brakes
Piano in MDF nero idrorepellente, alette laterali pieghevoli. Possibilità di rotazione del piano a 90° e consentire l'impilabilità. Ruote piroettanti ø 9,5 cm, di cui due con freno.





Mixer/liquidiser combi unit

Combi mixer/frusta
Kombigerät
Combiné mixeur-fouet
Brazo triturador/batidor, unidad combinada

art.	h. cm.	Kg.	kW	rpm
49907-01	79	4,95	0,35	15000

For containers up to 100 liters. – Per contenitori fino a 100 litri.



Liquidiser

Mixer
Stabmixer
Mixeur
Brazo triturador

art.	h. cm.	Kg.	kW	rpm
49907-06	55,5	1,45	0,25	15000

For containers up to 30 liters. – Per contenitori fino a 30 litri.



Wall rack

Supporto murale
Wandständer
Support murale
Soporte mural

art.
49907-AA



Liquidiser

Mixer
Stabmixer
Mixeur
Brazo triturador

art.	Kg.	kW	rpm
49807-00	1	0,2	0-13000



Mini liquidiser

Mini mixer
Mini-Stabmixer
Mini mixeur
Mini batidora

art.	h. cm.	Kg.	kW	rpm
49808-00	40	0,82	0,45	12500-14000

49808-AD
49808-AC



Liquidiser

Mixer
Stabmixer
Mixeur
Brazo triturador

art.	h. cm.	Kg.	kW	rpm
49911-24	24	1,4	0,27	2000-12500
49916-25	25	3,0	0,27	2300-9600
49916-35	35	3,3	0,35	2300-9600
49916-45	45	4,9	0,44	1500-9000
49916-55	55	5,2	0,75	9000

**Mixer/liquidiser combi unit**

Combi mixer/frusta

Kombigerät

Combiné mixeur-fouet

Brazo triturador/batidor, unidad combinada

art.	h. cm.	Kg.	kW	rpm
49911-19	19	1,9	0,25	2000-12500
49911-30	30	3,1	0,30	2300-9600
49911-35	35	5,9	0,44	1500-9000
49911-45	45	6,1	0,50	1500-9000

**Juice extractor J80 Ultra**

Centrifuga

Fruchtpresse

Centrifugeur-presse agrumes

Centrifugadora/exprimidor jugos

art.	cm.	kg./H	Kg.	kW	rpm
49949-20	23,5x42x50,5	60	11	0,7	3000

**Vegetable preparation machine CL 50 Ultra**

Tagliaverdure

Gemüseschneidmaschine

Coupe-légumes

Cortador verduras

art.	cm.	Kg.	kW	rpm
49940-01	30x36x55,5	15	0,55	375

Suitable also for cutting mozzarella. For cutting discs contact our customer service. – Ideale anche per tagliare mozzarella. Per i dischi di taglio contatta il ns customer service.

**Cutter & vegetable slicer R301 Ultra**

Combinato cutter/tagliaverdure

Gemüseschneid/- u. Schälmaschine

Cutter/Coupe-légumes

Cortador verduras

art.	cm.	lt.	Kg.	kW	rpm
49942-01	28,5x36x40	3,7	14	0,65	1500

For cutting discs contact our customer service.
Per i dischi di taglio contatta il ns customer service.

**Cutter & vegetable slicer R502 VV**

Combinato cutter/tagliaverdure

Gemüseschneid/- u. Schälmaschine

Cutter/Coupe-légumes

Cortador verduras

art.	cm.	lt.	Kg.	kW	rpm
49942-03	35,5x30x65,5	5,5	30	1,3	300-3500

For cutting discs contact our customer service.
Per i dischi di taglio contatta il ns customer service.

**Table-top cutter R4**

Cutter da tavolo

Gemüseschneidmaschine

Cutter à légumes

Cortador verduras

art.	cm.	lt.	Kg.	kW	rpm
49943-01	21x32x43	4,5	17	0,9	1500/3000



Table-top cutter R5 plus

Cutter da tavolo
Gemüseschneidmaschine
Cutter à légumes
Cortador verduras

art.	cm.	lt.	Kg.	kW	rpm
49943-02	28x34x48	5,5	24	1,2	1500/3000



Emulsifier-mixer Blixer 4

Omogeneizzatore
Mixergerät
Emulsionneur-mixer
Omogenizador/emulsificador

art.	cm.	lt.	Kg.	kW	rpm
49944-01	46x22,5x30,5	4,5	18	1	1500/3000



Emulsifier-mixer Blixer 4 VV

Omogeneizzatore
Mixergerät
Emulsionneur-mixer
Omogenizador/emulsificador

art.	cm.	lt.	Kg.	kW	rpm
49944-02	46x22,5x30,5	4,5	18	1,1	300>3500



Sieving juicer C80

Centrifuga
Passiermaschine
Centrifugeuse
Centrifugadora

art.	cm.	kg./H	Kg.	kW	rpm
49946-01	61x36x54	50	21	0,65	1500



Citrus fruit squeezer

Spremiagrumi
Zitruspresse
Presse agrumes
Exprimidor cítricos

art.	cm.	Kg.	kW	rpm
49922-01	20x30x35	5	0,13	1500



Citrus fruit squeezer

Spremiagrumi
Zitruspresse
Presse agrumes
Exprimidor cítricos

art.	cm.	Kg.	kW	rpm
49922-02	20,5x30,5x49	10	0,23	1500-1800



Citrus fruit squeezer

Spremiagrumi
Zitruspresse
Presse agrumes
Exprimidor cítricos

art.	cm.	Kg.	kW	rpm
49922-03	20x30x38	10	0,23	1500-1800



Citrus fruit squeezer

Spremiagrumi
Zitruspresse
Presse agrumes
Exprimidor cítricos

art.	cm.	Kg.	kW	rpm
49922-04	24x40x49	10	0,275	1500-1800



Juice extractor

Centrifuga, spremisucchi
Fruchtpresse
Centrifugeur-presse agrumes
Centrifugadora/exprimidor jugos

art.	cm.	Kg.	kW	rpm
49922-06	26x47x45	16	0,8	3000-3300



Ice crusher

Spaccaggiaccio
Eiszerstosser
Broyeur à glace
Triturador de hielo

art.	cm.	Kg.	kW	rpm
49922-08	24x35x47	10	0,13	73-89



Drink Mixer

Frullino
Getränkemixer
Shaker électrique
Batidora para batidos

art.	cm.	Kg.	kW	rpm
49949-09	18x18x53	6	0,12	8000-16000



Blender
Frullatore
Getränkemixer
Mixeur
Batidora de vaso

art.	cm.	lt.	Kg.	kW	rpm
49922-22	30x22x56,6	2	11	1,2	500-15000
49922-23	30x22x56,6	4	11	1,2	500-15000

Stainless steel bowl. – Bicchiere inox.



Blender
Frullatore
Getränkemixer
Mixeur
Batidora de vaso

art.	cm.	lt.	Kg.	kW	rpm
49922-20	30x22x56,6	2	11	1,2	500-15000
49922-21	30x22x56,6	4	11	1,2	500-15000

Clear bowl BPA Free. – Bicchiere trasparente BPA Free.



Blender
Frullatore
Getränkemixer
Mixeur
Batidora de vaso

art.	cm.	Kg.	kW
49922-09	20x47x44	9	3

Clear bowl BPA Free. – Bicchiere trasparente BPA Free.



Citrus fruit squeezer
Spremiagrumi
Zitruspresse mit Spritzschutz
Presse agrumes
Exprimidora

art.	cm.	Kg.	kW	rpm
49958-00	31x22x34	8	0,3	1400



Lever citrus fruit squeezer
Spremiagrumi a leva
Zitruspresse mit Pressarm
Presse agrumes à levier
Exprimidora

art.	cm.	Kg.	kW	rpm
49959-00	31x22x35	9	0,34	1400



Blender
Frullatore
Getränkemixer
Mixeur
Batidora de vaso

art.	cm.	lt.	Kg.	kW	rpm
49956-01	20x20x46	1,7	4	0,4	10000-15000

Plastic bowl. – Bicchiere plastica.

**Blender**

Frullatore
Getränkemixer
Mixeur
Batidora de vaso

art.	cm.	lt.	Kg.	kW	rpm
49957-00	23x23x52	3	5,5	1	12000-22000

Stainless steel bowl. – Bicchiere inox.

**Automatic ice crusher**

Tritaghiaccio automatico
Eiszerstosser
Broyeur à glace
Triturador de hielo automatico

art.	cm.	Kg.	kW	rpm
49960-00	42x21x29	11	0,34	1400

**Drink mixer**

Frullino
Getränkemixer
Shaker électrique
Batidora para batidos

art.	cm.	lt.	Kg.	kW	rpm
49955-01	20x22x50	0,8	2,8	0,12	15000

Plastic bowl. – Bicchiere plastica.

**Rice steamer**

Cuoci riso a vapore
Reiskocher
Cuit riz
Hervidor de arroz

art.	Ø cm.	h. cm.	lt.	kW
49954-21	5,0	35	21	3



SS

Steamer

Vaporiera
Dampfer
Cuit vapeur
Olla para cocinar al vapor

art.	Ø cm.	h. cm.	lt.	kW
49954-18	3,8	46	15	2



SS

Water boiler

Bollitore per acqua
Wasser-Kessel
Chauffe-eau
Caldera

art.	Ø cm.	h. cm.	lt.	Kg.	kW
49954-20	4,7	48	20	5,7	2,1



Planetary mixer

Impastatrice planetaria
Knet- u. Schlagmaschine
Batteur-mélangeur
Batodira planetaria

art.	cm.	lt.	Kg.	kW	rpm
49947-08	30x40x58	7,6	27	0,18	1420

3 speeds. Timer 0-15 min. – 3 velocità. Timer 0-15 min.



Planetary mixer

Impastatrice planetaria
Knet- u. Schlagmaschine
Batteur-mélangeur
Batodira planetaria

art.	cm.	lt.	Kg.	kW	rpm
49945-05	38x31x45,5	5	15	0,75	40x260

10 speeds. – 10 velocità.



SS

Microwave oven - PROG

Forno microonde
Mikrowelle
Four à micro-ondes
Microonda

art.	cm.	lt.	Kg.	kW
49997-12	54,2x46,1x32,9	30	18	1,6

5 power levels. Time key X2. Digital timer. 3 cooking stages, 5 power levels. 10 programmable keys. 20 programs.

5 livelli di potenza, da 200 a 1000W. Tasto tempo X2. Timer digitale. 3 stadi cottura e 5 livelli di potenza. 10 tasti programmabili. 20 programmi.



SS

Microwave oven - SELF

Forno microonde
Mikrowelle
Four à micro-ondes
Microonda

art.	cm.	lt.	Kg.	kW
49997-13	54,2x46,1x32,9	30	18	1,6

Time key X2. Digital timer. "START" button preprogrammed "1 minute" at full power. Parameters customizable.

Tasto tempo X2. Timer digitale. Tasto "START" pre-programmato "1 minuto" a piena potenza. Parametri pre-impostati personalizzabili.



Sous-vide cooking device

Apparecchio per cottura sottovuoto
Sous-Vide Garer
Cuiser bain marie - sous vide
Equipo para cocinar al vacío

art.	cm.	lt.	Kg.	kW
49954-22	36x29,2x29	11	5,9	0,85

Cooks food in vacuum-sealed pouches submerged in a water bath held at a precisely-controlled temperature from 30°C to 100°C.

Per cuocere a bagnomaria in buste sottovuoto. La temperatura è mantenuta precisamente costante e può essere regolata da 30°C a 100°C.



**Soft cooker**

Apparecchio per cottura sottovuoto

Sous-Vide-Garer

Thermoplongeur

Máquina para cocinar al vacío

art.	cm.	Kg.	kW
49851-10	16,4x22x41,5	8	0,2

Stainless steel structure. Suitable for containers up to 60 liters. Min. height of the tank 180 mm, electronic temperature control with 1/10°C precision, adjustable temperature 0>95°C. Pump for water circulation. Acoustic timer. Possibility to memorize up to 20 programs. Level sensor for lack of water.

Struttura in acciaio inox. Per recipienti fino a 60 litri. Altezza minima del recipiente 180 mm, controllo elettronico della temperatura con precisione al 1/10°C, temperatura regolabile 0>95°C. Pompa per la circolazione dell'acqua. Timer acustico. Possibilità di memorizzare fino a 20 programmi. Sensore di livello per mancanza acqua.

**NEW****Induction cooker TC 3500**

Piastra ad induzione

Induktionsplatte

Plaque à induction

Placa de inducción

art.	cm.	Kg.	kW
49998-35	35,5x46x11	5,5	3,5

Stainless steel body, Schott Ceran surface. Thermocontrol. 12 power levels. Temperature preselection 60-240°C. Timer 23 hours 59 min.

Corpo in acciaio inox, piano Schott Ceran. Thermocontrol. 12 livelli di potenza. Preselezione temperatura 60-240°C. Timer 23 ore 59'.

**Induction cooker**

Piastra ad induzione

Induktionsplatte

Plaque à induction

Placa de inducción

art.	cm.	Kg.	kW
58162-RA	30x37x10	6	2,7

Stainless steel body, Schott ceran surface. Timer 0-180 min. 10 power levels. Temperature range 60-240°C. – Corpo inox, piano Schott ceran. Timer 0-180 min. 10 livelli di potenza. Temperatura 60-240°C.

**Induction cooker, to be built into counter**

Piastra ad induzione, da incasso

Induktionsplatte, thekeneinbau

Plaque à induction, montage an comptoir

Placa de inducción para empotrar

art.	cm.	Kg.	kW
58162-RB	36X38x12,5	5,7	3,5

Schott ceran surface. Timer 0-180 min. 10 power levels. Temperature range 60-240°C. – Piano Schott ceran. Timer 0-180 min. 10 livelli di potenza. Temperatura 60-240°C.

**Induction cooker, to be built into counter**

Piastra ad induzione, da incasso

Induktionsplatte, thekeneinbau

Plaque à induction, montage an comptoir

Placa de inducción para empotrar

art.	cm.	Kg.	kW
49998-20	35,5x35,5x6	3,4	2

Schott ceran surface. 5 power levels. Temperature range 60-240°C. Piano Schott ceran. 5 livelli di potenza. Temperatura 60-240°C.



Induction adapter

Adattatore induzione
Induktion Adapterplatte
Disque relais pour induction
Adaptador para inducción

art.	Ø cm.
41922-16	16
41922-22	20



SS

Coffee percolator

Percolatore per caffè
Kaffee-Perkolator
Percolateur à café
Percolator de café

art.	Ø cm.	h. cm.	lt.	W
49846-05	28	38,5	4,5	950
49846-09	28	38,5	9,2	950
49846-15	33	54,0	15,0	1650



SS

Coffee urn

Scaldcaffè
Kaffeedispenser
Réchaud à café
Calentador de café

art.	cm.	lt.
41903-10	31x33,5x54,5	10,5



SS

Samovar

Samovar
Samovar
Samovar
Samovar

art.	h. cm.	lt.	W
58357E06	66	6+1*	1000
58357E09	74	9+1*	1000
58357E12	82	12+1,6*	1000

*Tea pot. – Teiera



SS

PP

Soup kettle

Zuppiera
Suppenwärmer
Marmite à soupe
Olla de sopa

art.	Ø cm.	h. cm.	lt.	W
49847-38	38	36,5	10	450-550



Dualit.

Soup kettle

Zuppiera
Suppenwärmer
Marmite à soupe
Olla de sopa

art.	Ø cm.	h. cm.	lt.	W
49804-11	34	33	11	850

**Soup kettle**

Zuppiera
Suppenwärmer
Marmite à soupe
Olla de sopa

art.	Ø cm.	h. cm.	lt.	W
49847-08	33	37	10	400

**Raclette cheese service, 1/4 shape**

Servizio raclette, 1/4 di forma
Raclette-Service
Fondeuse à fromage
Fundidora de queso

art.	cm.	Kg.	W
42420-04	28x24x34	3	600

**Raclette cheese service, 1/2 shape**

Servizio raclette, 1/2 forma
Raclette-Service
Fondeuse à fromage
Fundidora de queso

art.	cm.	Kg.	W
42420-08	26,5x53x40	3,7	900

**Sugar lamp**

Lampada per zucchero
Zuckerlampe
Lampe à sucre
Lámpara para azúcar

art.	cm.	Kg.
47840-11	61x41x50	6,4

Stainless steel. Infrared lamp, 3 selection powers 500-1000-1500W. Cable included. – Acciaio inox. Lampada infrarossi con 3 potenze selezionabili, 500-1000-1500W. Incl. cavo di alimentazione.

**Spray gun**

Pistola
Sprühpistole
Pistolet
Pistola

art.	ml.	Kg.	W	rpm
47848-07	700	1,1	60	280

Usable for hot liquids max. 65 °C. Equipped with nozzle 0,6 mm.
Per liquidi caldi max. 65°C. Bocchetta in dotazione da 0,6 mm.

**Tempering unit**

Temperatrice
Temperierungsmaschine
Tempereuse
Unidad temperator

art.	cm.	lt.
47698-03	40x24x13,5	3,6
47698-06	40x33x13,5	6,0

Dry heat analogue melters. Manual thermostat.
Scioglitori a secco analogici. Termostato manuale.



Airbrush compressor

Compressore per penna aerografa
Airbrush Kompressor
Compresseur
Compresor

art.	cm.	W
47844-06	16x30x23	200

Cap. 4 bar.



Caramelizer

Caramellizzatore
Caramelisier-Eisen
Carameliseur
Quemador

art.	Ø cm.	W
47847-10	10	0,65
47847-12	12	1



Meat mincer

Tritacarne
Fleischwolf
Hachoir
Tritador de carne

art.	cm.	Kg.	kW
49921-00	18x42x43	6	0,35



Meat mincer

Tritacarne
Fleischwolf
Hachoir
Tritador de carne

art.	cm.	Kg.	kW
49920-00	18x35x38	3,2	0,2



Slicer

Affettatrice
Aufschnitt-Maschine
Trancheur
Cortadora

art.	Ø cm.	cm.	Kg.	rpm
49975-19	19,5	52x36x31,5	10	300
49975U19*	19,5	52x36x31,5	10	300

***Extra CE. Built-in blade sharpener. – Extra CE. Affilatoio fisso.**



Slicer

Affettatrice
Aufschnitt-Maschine
Trancheur
Cortadora

art.	Ø cm.	cm.	Kg.	rpm
49975-25	25	62x42,5x37	15,5	300
49975U25*	25	62x42,5x37	15,5	300

***Extra CE. Built-in blade sharpener. – Extra CE. Affilatoio fisso.**



Slicer
Affettatrice
Aufschnitt-Maschine
Trancheur
Cortadora

art.	Ø cm.	cm.	Kg.	rpm
49975-22	22	58x40,5x34	10	300
49975U22*	22	58x40,5x34	10	300

*Extra CE. Built-in blade sharpener. – Extra CE. Affilatoio fisso.



Slicer
Affettatrice
Aufschnitt-Maschine
Trancheur
Cortadora

art.	Ø cm.	cm.	Kg.	rpm
49975-30	30	65x49,5x44	23	300
49975U30*	30	65x49,5x44	23	300

*Extra CE. Built-in blade sharpener. – Extra CE. Affilatoio fisso.



Slicer
Affettatrice
Aufschnitt-Maschine
Trancheur
Cortadora

art.	Ø cm.	cm.	Kg.	rpm
49975-35	35	89x58,5x48	36	260
49975U35*	35	89x58,5x48	36	260

*Extra CE. Built-in blade sharpener. – Extra CE. Affilatoio fisso.

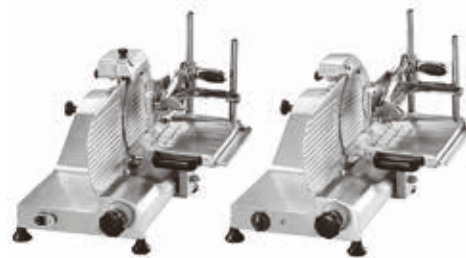

Slicer
Affettatrice
Aufschnitt-Maschine
Trancheur
Cortadora

art.	Ø cm.	cm.	Kg.	rpm
49974-25	25	53x52x50	24	300
49974U25*	25	53x52x50	24	300

*Extra CE. – Extra CE.



Slicer
Affettatrice
Aufschnitt-Maschine
Trancheur
Cortadora

art.	Ø cm.	cm.	Kg.	rpm
49974-30	30	53x52x50	27	300
49974U30*	30	53x52x50	27	300

*Extra CE. – Extra CE.



Sieve
Passaverdura
Passiergerät
Moulin
Molino

art.	Ø cm.	h. cm.	kg./H	Kg.	W
49879-37	37	108	300	23,5	600

Threephase motor 380V. Disc 3 mm. – Motore trifase 380V. Griglia 3 mm.



SS

Can opener
Apriscatole
Dosenöffner
Ouvre-boîte
Abrelatas

art. cm. Kg.
49814-00 44x25x75 13

Dual speed motor. Opens all can shapes from 50 to 270 mm height.
Motore a 2 velocità. Per formati scatola da 50 a 270 mm di altezza.



SS

Edlund

Can opener
Apriscatole
Dosenöffner
Ouvre-boîte
Abrelatas

art. cm. Kg.
49862-00 11x16x28 6,5

Dual speed motor. Cans max height 17 cm.
Motore a 2 velocità. Altezza max scatole 17 cm.



SS

Knife sterilizer
Sterilizzatore per coltelli
Messerentkeimer
Armoire de sterilisation
Esterilizador para cuchillos

art. cm. W
49871-10 57,5x17x60 15

Plexiglas door, magnetic lock. Timer setting from 0 up to 2 hours. Door with stop device when opening. Protection IP 24.

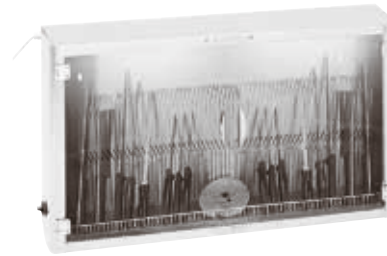

SS

Knife sterilizer
Sterilizzatore per coltelli
Messerentkeimer
Armoire de sterilisation
Esterilizador para cuchillos

art. cm. W
49871-20 103x17x60 30

Porta in plexiglas, chiusura magnetica. Programmabile da 0 a 2 ore. Dispositivo d'arresto all'apertura porta. Indice di protezione IP 24.



Edlund

Knife sharpener
Affilacoltelli
Messerschleifapparat
Aiguiseur
Afilador

art. cm. Kg. W rpm
49872-00 25x10x12 4 172 1550

ABS knife guide. Pressure sensitive motor shuts down automatically.
Guida in ABS estraibile. Motore con dispositivo autobloccante.



Knife sharpener
Affilacoltelli
Messerschleifapparat
Aiguiseur
Afilador

art. cm. Kg.
49741-15 23x33x16 6,4
49741-07 23x16x16 4,6

CUCINA SENZA GLUTINE

FOR GLUTEN-FREE COOKING



UNA LINEA COMPLETA DI ARTICOLI E STRUMENTI
PROFESSIONALI FACILMENTE IDENTIFICABILI PER:

- diminuire il rischio di accidentali contaminazioni crociate degli alimenti;
- facilitare il professionista nell'operare e nell'offrire un servizio a favore del cliente con intolleranza al glutine;
- sensibilizzare il settore sul tema "gluten free" di fronte alle nuove esigenze dei consumatori.

A FULL LINE OF HORECA TOOLS AND ITEMS,
EASY TO IDENTIFY, AIMED AT:

- reducing the risk of accidental food cross-contamination;
- making it easier for professionals to work and to provide services to clients with gluten intolerance;
- raising awareness on the gluten-free diet issue in the industry so as to respond to the new needs of consumers.



Frypan

Padella

art.	Ø cm.
S11014-20_13001	20
S11014-24_13001	24
S11014-28_13001	28
S11014-32_13001	32



Cover

Coperchio

art.	Ø cm.
S11161-16_14001	16
S11161-20_13001	20
S11161-24_13001	24
S11161-28_13001	28



Baking sheet alusteel

Teglia forno, acciaio alluminato

art.	Ø cm.
S11739-20_13001	20
S11739-24_13001	24
S11739-28_13001	28
S11739-32_13001	32



Strainer with hook

Colapasta con manico e gancio

art.	Ø cm.
S11924-20_13001	20



Conical colander

Colapasta tronco conico

art.	Ø cm.
S11930-24_13001	24





One piece ladle
Mestolo unipezzo

art.	Ø cm.
S11970-06_13001	6,5
S11970-08_13001	8,0
S11970-10_13001	10



One piece skimmer
Schiumarola unipezzo

art.	Ø cm.
S11971-10_13001	10
S11971-12_13001	12



One piece perforated spatula
Paletta forata unipezzo

art.	Ø cm.
S11973-10_13001	10
S11973-12_13001	12



One piece basting spoon
Cucchiaione unipezzo

art.	
S11982-38_13001	



Stock pot
Pentola alta

art.	Ø cm.
S12001-20_13001	20
S12001-24_13001	24
S12001-28_13001	28



Saucepot 2 handles
Casseruola alta 2 maniglie

art.	Ø cm.
S12007-16_13001	16
S12007-24_13001	24
S12007-28_13001	28



Colander for low stock pot
Colapasta per pentola bassa

art.	Ø cm.
S12123-20_13001	20
S12123-24_13001	24
S12123-28_13001	28



Wire whip, 8 wires
Frusta 8 fili

art.	l. cm.
S12928-30_13001	30
S12928-35_13001	35



Egg whisk, 11 wires
Frusta 11 fili



art.	l. cm.
S12929-30_13001	30
S12929-35_13001	35



Gastronorm Container
Bacinella gastronorm



art.	GN	dim. cm.
S14102-02_13001	1/1	53x32,5x2
S14102-04_13001	1/1	53x32,5x4
S14102-06_13001	1/1	53x32,5x6,5
S14102-10_13001	1/1	53x32,5x10
S14102-15_13001	1/1	53x32,5x15
S14102-20_13001	1/1	53x32,5x20
S14103-02_13001	2/3	35,3x32x2
S14103-04_13001	2/3	35,3x32x4
S14103-06_13001	2/3	35,3x32x6,5
S14103-10_13001	2/3	35,3x32x10
S14103-15_13001	2/3	35,3x32x15
S14103-20_13001	2/3	35,3x32x20
S14104-06_13001	2/4	53x16,2x6,5
S14104-10_13001	2/4	53x16,2x10
S14104-15_13001	2/4	53x16,2x15
S14105-02_13001	1/2	32x26,5x2
S14105-04_13001	1/2	32x26,5x4
S14105-06_13001	1/2	32x26,5x6,5
S14105-10_13001	1/2	32x26,5x10
S14105-15_13001	1/2	32x26,5x15
S14105-20_13001	1/2	32x26,5x20
S14107-06_13001	1/3	32,5x18x6,5
S14107-10_13001	1/3	32,5x18x10
S14107-15_13001	1/3	32,5x18x15
S14107-20_13001	1/3	32,5x18x20
S14108-06_13001	1/4	26,5x16x6,5
S14108-10_13001	1/4	26,5x16x10
S14108-15_13001	1/4	26,5x16x15
S14108-20_13001	1/4	26,5x16x20
S14109-06_13001	1/6	17,6x16x6,5
S14109-10_13001	1/6	17,6x16x10
S14109-15_13001	1/6	17,6x16x15
S14109-20_13001	1/6	17,6x16x20
S14110-06_13001	1/9	17,6x11x6,5
S14110-10_13001	1/9	17,6x11x10



Gastronorm cover
Coperchio gastronorm



art.	GN
S14502-00_13001	1/1
S14503-00_13001	2/3
S14504-00_13001	2/4
S14505-00_13001	1/2
S14507-00_13001	1/3
S14508-00_13001	1/4
S14509-00_13001	1/6
S14510-00_13001	1/9



Bread knife
Coltello pane



art.	l. cm.
S18028-21_13001	21
S18028-25_13001	25
S18028-30_13001	30
S18028-36_13001	36



Pizza wheel
Rotella tagliapizza

art.	Ø cm.
S18324-10_13001	10



Spatula perforated
Spatola pasticcio e pizza forata

art.
S18510-07_13001



Pizza turner
Spatola per pasticcio e pizza

art.
S18511-15_13001



Pastry spatula
Spatola per dolci

art.
S18513-14_13001



Baking sheet alusteel
Teglia rettangolare, alluminata

art.	dim. cm.
S41751-30_13001	30x23x3
S41751-40_13001	40x30x3
S41751-60_13001	60x40x3



Cutting board
Tagliere

art.	GN	dim. cm.	col.
S42522-09_13001	1/2	32x26,5x2	●



Cutting board
Tagliere

art.	GN	dim. cm.	col.
S42538-09_13001	1/1	53x32,5x2	●



Cutting board
Tagliere

art.	dim. cm.	col.
S42539-09_13001	60x40x2	●



Bread tongs
Molla pane

art.	l. cm.
S52550-63_13001	23





Spaghetti tongs

Molla spaghetti

art. l. cm.
S52550-73_13001 21



Toast-pastry tongs

Molla toast-dolci

art. l. cm.
S52550-78_13001 24



Cake pliers

Pinza torta

art. l. cm.
S52550-80_13001 28



Pastry pliers

Pinza dolci

art. l. cm.
S52550-88_13001 18



SPARE PARTS
RICAMBI



Tap/Rubinetto : For/Per # 11102

art.
11102-99



Roasting pan grid/Griglia brasiera : For/Per # 11965

art. dim. cm.
11966-50 50x30
11966-60 60x35
11966-61 61x43



Cutlery bag

Borsa porta coltelli

art.
18190-AA



Spare parts/Ricambi : For/Per # 19810-00

art. des
19810-AA Blade/Lama
19810-AB Gear/Ruota dentata



Spare porcelain/Ricambio porcellana : For/Per # 41311-00

art.
41311-AA



Non slip feet/Piedini antiscivolo : For/Per # 41323

art. U. Pack
41323-AA 6



Folding lid/Coperchio a ribalta

art. Ø cm.
41400-AB 23,5
41405-AB 13,5



Cereal-bar glass/Barattolo cereali, vetro : For/Per # 42460-43; 42470-43

art. lt.
41402-AA 2



Eutectic pad/Eutettico : For/Per # 41488

art. Ø cm. h. cm.
41443-AE 10,5 2



Tray/Vassoio : For/Per # 41447-05

art.
41447-39



Stoppers/Tappi pompa : For/Per # 41499-00

art. pcs/pz
41499-AA 2



China cup/Porcellana : For/Per # 41563-07

art.
41563-AA



China cup/Porcellana : For/Per # 41564-07,

art.
41564-AA

**Cheese jar/Vetro formaggiera : For/Per # 41638-01**

art.

41638-91

**Spare parts/Ricambi : For/Per # 41638-02-04-12-13**

art.

des

41638-92

Oil/Winegar bottle/Ampolla olio/acetato

41638-93

Salt shaker/Vetro spargi sale

41638-94

Pepper shaker/Vetro spargi pepe

41638-95

Toothpick glass/Vetro porta stecchi

**Brush/Spazzola : For/Per # 41767-20**

art.

41767-AA

**Euthetic pad/Eutettico tondo**

art.

Ø cm.

h. cm.

41910-AL

15

2,5

**Spare parts/Ricambi : For/Per # 41911**

art.

des

41911-AA

Canister/Contenitore

41911-AE

Slide SAN/Scivolo SAN

**Cover/Tappo : For/Per # 42401**

art.

42401-AA

**Cover/Tappo : For/Per # 42505**

art.

42405-AA

**Set 10 blades/Set 10 lame : For/Per # 42520-00**

art.

42520-AA



Spare parts/Ricambi : For/Per # 42570-32

art.	des	mm.
42570-91	Disc/Griglia	1,5
42570-92	Disc/Griglia	2,5
42570-94	Disc/Griglia	4,0
42570-99	Cranck/Manovella	



Spare parts/Ricambi : For/Per # 42573-31

art.	des	mm.
42573-91	Disc/Griglia	1,5
42573-92	Disc/Griglia	2,5
42573-94	Disc/Griglia	4,0
42573-99	Cranck/Manovella	



Spare parts/Ricambi : For/Per # 42574-37

art.	des	mm.
42574-90	Disc/Griglia	1,0
42574-91	Disc/Griglia	1,5
42574-92	Disc/Griglia	2,0
42574-93	Disc/Griglia	3,0
42574-94	Disc/Griglia	4,0
42574-99	Cranck/Manovella	



Spare parts/Ricambi : For/Per # 42575-37

art.	des	mm.
42575-90	Disc/Griglia	1,0
42575-91	Disc/Griglia	1,5
42575-92	Disc/Griglia	2,0
42575-93	Disc/Griglia	3,0
42575-94	Disc/Griglia	4,0
42575-99	Cranck/Manovella	



Spare parts/Ricambi : For/Per # 42577-39

art.	des	mm.
42577-90	Disc/Griglia	1,0
42577-91	Disc/Griglia	1,5
42577-92	Disc/Griglia	2,0
42577-93	Disc/Griglia	3,0
42577-94	Disc/Griglia	4,0
42577-99	Cranck/Manovella	



Spare parts/Ricambi : For/Per # 42929-03

art.	des
42929-AA	Salt shaker/Vetro spargisale
42929-AB	Pepper shaker/Vetro spargipepe
42929-AC	Oil/Winegar bottle/Ampolla olio/acetato



Glass/Vetro : For/Per # 42939-15

art.
42939-AA

**Glass/Vetro lampada : For/Per # 42941-22**

art.

42941-AA

**Wheel/Ruota : For/Per # 44023-00 # 44024-00**

art.

44023-AA

**Dish separation grid /Griglia divisoria : For/Per # 44027-00**

art.

44027-AA

**Sponge/Spugna : For/Per # 44101-03**

art.

44101-AA

**Container/Contenitore : For/Per # 44103**

art.

des

44103-AA

3 comp.

44103-AB

4 comp.

44103-AC

6 comp.

**Flat mop/Frangia mop : For/Per # 44160-03**

art.

44160-AA

**Trolley bags/Sacchi carrello : For/Per # 44174-24**

art.

44174-AA

**Burner/Portacombustibile : For/Per # 44225-22; 44227-30**

art.

44220-AA



Cream puff nozzle/Beccuccio riempi bigne' : For/Per # 47612-01

art.
47612-AA



Bone-saw blade/Lama per sega : For/Per # 48231

art.	mm.
48232-40	400
48232-45	450
48232-50	500



Spare parts/Ricambi : For/Per # 49811-00

art.	des
49811-01	Cutting knife kit/Kit lama
49811-02	Blade/Lama



Spare parts/Ricambi : For/Per # 49812-00

art.	des
49812-01	Blade and wheel/Lama e ruota dentata
49811-02	Blade/Lama



Spare parts/Ricambi : For/Per # 49814-00

art.	des
49811-02	Blade/Lama
49814-01	Blade and wheel/Lama e ruota dentata



Set 7 blades/Set 7 lame : For/Per # 49829-11

art.
49829-BA



Spare parts/Ricambi : For/Per # 49830-60

art.	des
49830-00	Slicer/Mandolino
49830-02	Protective carriage/Carrello
49830-AA	38 Blades/Pettine 38 lame
49830-AB	44 Blades/Pettine 44 lame
49830-AC	60 Blades/Pettine 60 lame



Spare parts/Ricambi : For/Per # 49832-10

art.	des	mm.
49832-80	Pusher/Pressatore	10
49832-86	Pusher/Pressatore	6
49832-88	Pusher/Pressatore	8
49832-90	Blade/Lama	10
49832-96	Blade/Lama	6
49832-98	Blade/Lama	8
49832-99	Carriage/Guida di scorrimento	



Spare parts/Ricambi : For/Per # 49834-00

art.	des
49834-01	Peeling blade/Lama a pelare
49834-02	Slicing blade/Lama affettare



Spare parts/Ricambi : For/Per # 49835-00

art.	des
49835-01	Peeling blade/Lama a pelare
49835-02	Slicing blade/Lama affettare



Blade assembly/Set lame : For/Per # 49837-05

art.
49837-AA



Blade assembly/Set lame : For/Per # 49838-08

art.
49838-AB



Corkscrew worm/Verme cavatappi : For/Per # 49858-00

art.
49858-AA



Grinding wheel assembly/Set ruota molatrice : For/Per # 49872-00

art.
49870-AA



Disc/Griglia : For/Per # 49879-37

art.	mm.
49879-90	1,0
49879-91	1,5
49879-92	2,0
49879-93	3,0
49879-94	4,0



Pedal & opening assembly/Pedaliere e movimento : For/Per # 49899-01

art.
49899-AA



Glass/Bicchiera : For/Per # 49956-01

art.
49956-AA



Clutch left, Asia rectangular/Frizione sx Asia rettangolare

art.
58132-KP



Clutch right, Asia rectangular/Frizione dx Asia rettangolare

art.
58132-KQ

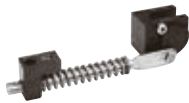

Clutch right Asia /Frizione dx Asia

art.	Ø cm.
58136-KQ	33-40

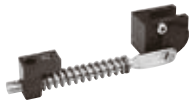

Clutch left, Asia/Frizione sx Asia

art.	Ø cm.
58136-KP	33
58136-KR	40



Clutch spring for rect. ABS, long side opening/Frizione molla ABS rett., apertura lato lungo

art.
58162-AF



Clutch spring for rect. ABS, short side opening/Frizione molla ABS rett., apertura lato corto

art.
58162-AG



Spare parts/Ricambi : For/Per # 58166A

art.	des	Ø cm.
58166-AD	Clutch/Frizione	24
58166-AE	Clutch/Frizione	36
58166-AF	Clutch/Frizione	40
58166-AH	Clutch/Frizione	30



Spare parts/Ricambi : For/Per # 58172A54

art. des
58172-AF Clutch spring/Frizione molla



Spare parts/Ricambi : For/Per # 58172A56

art. des
58172-AG Clutch spring/Frizione molla



Spare parts/Ricambi : For/Per # 58176A

art. des
58176-AE Clutch for ABS Ø cm 36/Frizione ABS Ø cm 36
58176-AF Clutch for ABS Ø cm 40/Frizione ABS Ø cm 40
58176-AH Clutch for ABS Ø cm 30/Frizione ABS Ø cm 30



Spare parts/Ricambi : For/Per # 58353-17

art. des
58333-AA Juice container/Contentitore succhi
58333-BB Tap/Rubinetto
58333-VA Eutectic pad/Contentitore eutettico



Display for fry pans/Espositore per padelle ferro

art.
XO1046

ALPHABETICAL INDEX

INDICE ALFABETICO

ALPHABETISCH INDEX

TABLE DES MATIERES

INDICE ALFABETICO

A					
Absinthe spoon	289	Buffet And Presentation articles	362-401	Cocktail glass	295
Acetate sheets	197	Buffet diplay	372, 373	Cocktail picks	307
Adaptor bar	58	Buffet ladder	396	Cocktail spoon	94, 289
Air pot	399-400	Buffet showcase	381, 384, 392-393	Cocktail strainer	290
Airbrush	189	Buffet stand	383, 394	Cocoa dredger	271
Airbrush compressor	189, 472	Butchers table	159	Coffee measuring spoon	93
Almont past knife	174	Butter churn	124	Coffee percolator	470
Apple corer/wedger	90, 93, 117	Butter cup	335	Coffee urn	412, 416, 470
Apple peeler	116	Butter curler	89, 94	Cognac warmer	350
Apron	162	Butter spreader	87, 92, 314	Colander	84, 109-111
Ash shovel	262	C		Condiment holder	301
Ashtray	353, 354	Cake cooling tray	187	Condiment set	340
Ashtray, floor standing	452	Cake frames	198-201	Cones dispenser	278
Asparagus peeler/tong	89, 313	Cake marker	193	Confectionery funnel	188
Avocado peeler/slicer	118	Cake peel	186	Contact Grill	455-456
B		Cake rings	197-200	Containers/boxes	432-433
Bag clip	114	Cake server	313	Cookie press	185
Bain-marie	23, 28, 35	Cake slicer	190	Cookie cutter frames	210-211
Bake roasting pan	22, 27, 28, 35	Cake stand	274-275	Cooking oil tester	133
Baker's blades	247	Cake tray	274	Cooking tong	104, 105
Baking beans	197	Cake-plate, swivel base	186	Cookware, 3-Ply	19-20
Baking paper/sheet	196, 197, 268	Can opener	88, 92, 93, 126, 128	Cookware, Copper INDUCTION	31-32
Baking sheet trolley	440-441	Can opener, electric	474	Cookware, Pots & Pans, Aluminum	24-28
Baking tray	187	Candles	378	Cookware, Pots & Pans, Copper	33,-35
Balloon whisk	84	Candleholder	352	Cookware, Pots & Pans, Enamelled Cast Iron	38-46
Balti pan	257	Candlestick/Candelabra	351	Cookware, Pots & Pans, Stainless Steel	8-18
Bar organizer	298	Canister	23	Cool bowl	384, 394
Bar runner	301	Caramelising rod	188, 472	Corkscrew	305-306
Bar, Happy Hour articles	283-310	Card holder	352	Couscous pan	25
Barbecue brush	105	Cash tray	273	Covers for trolley	439
Barman's set	302	Cash tray	273	Cream dispenser/injector	188
Basket	373	Caviar cooler	347	Cream roll/horn molds	184
Baster tube	104	Caviar flatware	347	Cream whipper	280
Basting spoon	102	Cereal dispenser	383, 397-398	Crepe machine	456-457
Beer glass	293	Chafing-Dish	403-416	Crepe spreader	103
Bento box	251	Chainmail glove	160	Croissant cutter	193
Beverage dispenser, insulated	399, 437	Chalkmarker	392	Cube cutter	115
Bird nest fryer	102	Champagne glass	284, 294	Cutlery box/holder	341, 384, 425-426
Blender	466	Champagne saber	350	Cutter & vegetable slicer	463
Bone-saw	156	Champagne stopper	305	Cutting board	158-159, 391, 394
Boston shaker	292	Champagne tong	350	D	
Bottle cooler	348-350	Champagne Waterfall	401	Dash bottle	298-299
Bottle for rum spraying	195	Changing table	444	Dash bottle	298-299
Bottle opener	88, 92, 306	Cheese grater	88, 119	Decorating spoon	174
Bottle rack	303	Cheese jar	341	Decorating spoon	174
Bouillon cloth	113	Cheese knife	87, 91	Dehydrator	459
Bourguignonn fondue set	345	Chef's set	151	Digital timer	133
Bowl holder	394	Chef's torch	189	Dipping forks	174, 345
Bowl/Salad bowl	249-250, 317-321, 362-372, 375	Cherry core stripper	119-120	Dish dolly	427
Bread basket	337, 386-391	Chinese colander	113	Dish rack	427
Bread brush	247	Chinese hot pot	258	Dish-warmer	458
Bread mould	246	Chinese spoon	253	Dishwasher Racks	424-425
Bread proofing basket	247	Chocolate bars molds	218	Dispenser	303-304
Bread slicer	386	Chopstick rest	254	Display tray	156, 195-196
Bread, Accessories	245-247	Chopsticks	254, 259	Doilies	186
Breakfast tray with legs	378	Christmas molds	221	Dolly	426, 431
Breakfast-service trolley	439	Cigar humidior	353	Dome cover	342
Broom	446	Cigar scissors	353	Dough box	266
Brush for grill	263	Cinnamon star cutter	172	Dough cutter	265
Bucket	111	Citrus fruit squeezer, electric	464, 466	Dough scraper	194, 265
Bucket with wringer	449	Citrus knife	89	Doughnut cutter	172
		Clay pot	258	Drainer for silicone baking sheets	229
		Cleaning articles	444-452	Drainer plate	58-70
		Cocktail fountain	401	Draining rack	187, 427
				Dressing spoon	315

Drink stirrers	288
Dumpling maker	126
Dunnage rack	452
Dust beater	446
Dustpan	447

E

Easter molds	220-221
Egg basket	391
Egg container	117
Egg cup	327
Egg mold	219-200
Egg rings	117
Egg separator	94
Egg wedger	117
Egg boiler	457
Electric appliances	454-474
Electric heating units	405, 416
Electric peeler	116
Electric spray gun	189
Emulsifier	464
Escargot dish	347
Escargot fork	315
Ethnic cuisine articles	249-259
Eutectic pad	383, 435
Expanding pastry cutter	192

F

Film box	105
Fingerfood	323-324
Fish & chips spatula	82
Fish kettle	22, 28, 35
Fish scaler	86, 91, 259
Fish-bone remover	104
Flair bottle	298
Flambé burner	345
Flambé pan	346
Flat plate	252, 317, 319, 321
Flexipan molds	231-243
Floor sign	448
Flour brush	195
Flour scoop	108
Flour sifter	195
Flower vase	350
Foil cutter	305
Fondue set	35, 345
Food container	429-431, 437
Food loops	114
Fork	95
Free flow pourer	304
French fry cutter	118
French fry scoop	103
French press	325
Fruit basket	296, 336
Fruit cutter	115
Fruit decorating knife	90
Fruit scoop	89
Fruit stand	347, 400
Fruit tong	312
Fry basket	58, 259
Fry dripping tray	22
Fryer	457-458
Fuel Holder	406, 415
Funnel	106

G

Garlic press	92, 119
Gastronorm Containers	50-79
Gastronorm Food Pans, Melamine	76-77
Gastronorm Food Pans, Polycarbonate	61-65
Gastronorm Food Pans, Polypropylene	69-75
Gastronorm Food Pans, Porcelain	78-81
Gastronorm Food Pans, Stainless Steel	52-60
Gastronorm Food Pans, Tritan	66-67
Glass cleaning brush	303
Glass rack	302
Glass rimmer	301
Glasses	293-296
Glasses with cover	330-331
Gloves	161-162
GN-baking sheets	56
Gourmet glass serving stand	331
Grape scissor	312
Grapefruit knife	89, 93
Graters	92, 119, 124-125
Griddle plate	41, 42, 44
Grill pan	40, 41
Grill stone with stand	345
Grill tweezer	104
Grills For Biscuit	209-211
Guitar	114, 191

HI

Ham stand	156
Hamburger press	157
Hamburger turner	98
Ham-tong	155
Hangiri/sushi rice tub	256
Hat pin for tickets	105
Heat accumulator	435
Herb mill	126
Herb scissors	118
Honey/cream dispenser	271
Hooks	154-155
Hot dog heater	456
Housekeeping cart	445-446
Hydrometer for brine and salt	133
Ice box/bucket	297, 298, 384, 437
Ice cart	437
Ice chisels	124
Ice cream articles	277-281
Ice cream cone holder	277
Ice cream container	278
Ice cream cup	277
Ice cream maker	459
Ice cream scoop	93, 279
Ice crusher	297, 465, 467
Ice pick	296
Ice scoop/spoon	297, 315, 437
Ice tea spoon	289, 315
Ice tong	297, 313
Icing bag	184-185
Icing bag holder	186
Icing sugar sieve	195
Induction adapter	470
Induction cooker	404, 469
Infrared lamp	461
Insulated beverage server	325

Insulated containers	265, 434-437
Iron pans	30
Japanese jigger	291

JKL

Japanese omelettes pan	257
Jelly fuel	416
Juice dispenser	383, 398-399
Juice extractor	463, 465
Juice glass	293
Juice pitcher	326
Julep mug	286
Julep strainer	290
Kaiser bread marker	247
Kitchen Accessories/Tools	81-135
Kitchen scissors	149-150
Kitchenbowl	109-112
Knife block	152-153
Knife rack	153
Knife roll-bag	152
Knife sanitizing system	153
Knife sharpener, electric	474
Knife sterilizer, electric	474
Knives And Accessories	137-162
Ladder	452
Ladles	82, 94, 102, 259, 314
Lanterns	377
Larding needle	154
Lasagne spatula	98
Le Rouet	122
Lemon squeezer	296
Lemon striper	90, 94
Lightning column	401
Liquidiser	462
Lobster cracker	346
Lobster forks/picks	346
Long-drink shaker	291-292

M

Magic spoon whisk	289
Magnetic knife rack	153
Magnetic molds	218
Mandoline cutter	120
Mango cutter	118
Manual sharpener	153
Margarita cup/glass	284, 293, 296
Martini cup	284, 294, 295
Measuring cups/spoons	107, 290-291
Measuring jug	106
Measuring pourer	304
Meat fork	96, 102, 138-146, 314
Meat mincer	472
Meat pan	156
Meat tenderizer	155-156
Melon baller	88, 93
Melon peeler	89
Menu stand	352
Mesh skimmer	102
Microwave oven	468
Milk dispenser	399
Milk pot	271
Mills Pepper/Salt	355-360
Miniatures	33, 36, 37
Minibar restocking cart	441

Mirrors	376-377	Pepper mill	339	Sake warmer	253
Mixing bowl	35, 111-112	Perforated ladle	83, 100	Salad bowl	336
Mixing glass	293	Perforated sauce ladle	314	Salad fork/spoon	94-95
Mold for ice-balls	297	Perforated spatula	83, 97	Salad spinner	112
Monoportion fork/spoon	315	Perforated spoon	82, 95, 102	Salami pricker	153
Mopping trolley	448	Perforated turner	96	Salt manager	133
Mops	446-447	Peugeot mills	355-360	Salt mill	339
Mortar and pestle	258	Pie knife/plier	87, 98, 312	Salt spoon	314
Moscow mule mug	284-286	Pie server	95	Salt/pepper shaker	339
Muddler	297	Pineapple coring tool	88, 116	Samovar	412
Multi rack	395	Pineapple cup	284	Sauce boat	336
Multipurpose box	427	Pinneapple slicer	116	Sauce ladle	94, 102, 314
Multipurpose trolley	448	Piping tip adapter	183	Sauce pourer	252
Mushroom cutter	118	Pizza delivery bag	265	Sausage tongs	104
Mussel pot	346	Pizza knife	86, 264	Scales	134-135
Mustard cup	335	Pizza peel	261-262, 264	Sea urchin cutter	346
NO		Pizza peel rack	263	Seafood display rack	347
Napkin holder	272-273, 342	Pizza scissors	264	Segment colander	23
Newspaper stick	378	Pizza screen	266	Serving board	334
Nigiri mould	255	Pizza sheet	267-268	Serving fork/spoon	313
Nitro Whip	270	Pizza turner	98	Serving stand	362-363
Noodle strainer	258	Pizza wheel	86, 90, 264	Serving tongs	82, 104, 312-314
Nut-cracker	346	Pizza, Accessories	260-268	Serving trolley	440
Octopus-press	114	Planetary mixer	468	Sharpening steel/stone	146
Oil pourer	258, 261	Plate cover	106	Showcase	273
Oil/vinegar sprayer	340	Plate racks	438	Sieve	108-109, 195
Olive seed remover	119-120	Plate warmer	44, 345	Sign holders	392
One piece ladle	100	Plate/Platter	367, 371	Silform	244-245
One piece meat fork	100	Platform cart	441-442	Silicone baking sheet	196
One piece perforated spatula	101	Potato masher	91	Silpain	196
One piece skimmer	101	Potato peeler	89, 93, 118	Silpat	196
One piece spatula	101	Potato ricer	118	Sink trolley	431
One piece spoon	100	Poultry shears	151	Sizzler platter	258
Orange juicer	296	Pourer	350	Skewers	154, 254, 307
Orange peeler	89, 93	Pouring container cap	301	Skimmer	82, 95, 259
Oven mitts	160-161	Presse canard	114	Slicer	157
Oven, multifunction	457	Protective apron	160	Slicer, electric	472
Overshoes	162	Pumpkin mug	284	Small dish	252-253
Oyster fork/knife	86, 92, 315	Punch bowl	400	Smell-remover soap	94
Oyster plate	347, 401	PVC ribbon	197	Smoker	459
P		R		Smoother	190
Pan gripper	264	Rack GN	439-441	Snack holder	308-310
Panettone knife	313	Raclette cheese service	345	Snail tong	313
Paper Chef hat	162	Rake	262	Soba choko cup	251
Parmesan spoon	314	Reception bell	353	Soda siphon	296
Party spoon	365-366	Rectangular Plate	317, 319	Soft cooker	469
Party tray	317, 319, 363	Recycling station	450	Solvable labels	134
Party tub	401	Refuse bag holder trolley	451	Soup bowl	336
Pastry brush	87, 92, 194	Relish dish	365	Soup kettle	416
Pastry Cutters, Pa+	173	Revolving platter	328	Soup kettle, electric	470
Pastry Cutters, Stainless Steel	164-172	Rice bowl	249	Soup plate	317, 319, 321
Pastry Molds, Aluminum	201	Rice ladle/spoon	95, 114, 255, 314	Soup spoon	252
Pastry Molds, Non-Stick	203-208	Rice steamer	467	Soup strainer	84, 91
Pastry Molds, Silicone	212, 222-229	Roll holder	105, 439	Soup/rice bowl with lid	251
Pastry plier	312	Rolling pin	193-194	Sous-vide cooking device	468
Pastry spatula	83, 98	Roll-top cover	392, 394	Soy pot	253-254
Pastry stand	273	Roul'Pat	196	Spaghetti tong/server	82, 95, 102, 312
Pastry tube brush	183	Ruler	190	Spare parts	479-487
Pastry Utensils	164-247	Runner	344	Spatulas	81-83, 92, 95, 98, 103, 105, 259
Pastry wheel	86, 90, 192	S		Speed rack	105, 302
Pedal bin	451	Sake cup	253	Spoon	81-83
Peeler	89, 93, 115	Sake jug	253	Spoon case	277
				Spoon holder	272
				Spoon mold	219
				Spray gun	471

Squeeze bottle	107-108	Tomato juicer sieve	126
Stand	370-371, 373-375	Tomato peeler	89
Stand/basket	374	Tongs	82, 313
Steamer	255, 257, 467	Toothpicks	307
Steel frying pans	30	Tortillas wedger	119
Stencils	212	Towel tray	251
Step on bin	449	Transport & Storage Articles	424-442
Stirring ladle	81	Tray	249-250, 320-321, 327-328
Storage box/container	428, 431	Tray	332-334, 364, 368-372, 378-380
Store & pour canister	299	Tray stand	378
Strainer	84, 112-113	Trivet	346
Straws	287	Trolley 3 levels	427
Straw holder	272, 277	Trolley Quick Cart	444
String holder	156	Trolleys, dining-room service	418-422
Sturdy chair	444	Truffle-slicer	338
Sugar bulb	190	Tubes	175-183
Sugar dredger	195	Tumbler	294-295
Sugar gloves	161	Tweezer	289
Sugar lamp	189, 471		
Sugar packet holder	272	V Vacuum pump wine preserver	307
Sugar pourer	271	Vegetable cutter	90, 115
Sugar saucepan	35	Vegetable decorating tools	122
Sugar thermometer	190	Vegetable sharpener	87
Sugar tong	313	Vegetable sieve	126-127
Sushi geta board	251	Vegetable sieve, electric	473
Sushi mat	255	Vegetable slicer	118, 120-121
Sushi serving dish	251	Vegetables knife	86, 91
Sushi sashimi boat	252	Vertical manual sausage filler	157
Sweeper	446	Vinyl bag	445
Sweet box	273	Visitor kit, TNT	162
Swords	154		
Syrup density meter	133, 190		

T

Table bag holder	348	Waffle case	277
Table barbecue	42	Waffle iron	459
Table caddy	342	Wall clock	134
Table crumbler	342	Wall rack	102
Table mats	344	Wall rack for icing bags & nozzles	186
Table number stand	352	Warming display	458
Table sign	353	Warming plate	461
Table Top Service Articles	312-354	Wasabi grater	258
Table top waste bin	346	Waste container	449
Table-cloth clips	342	Water boiler	467
Table-top cutter, electric	459	Water jug	325-326
Tart ring	197-198	Wedding cake stand	400
Tasting glasses	307-308	Whisk	84, 90, 96, 102, 105
Tasting/dessert set	329	Whistling kettle	22
Tawa pan	257	Wine aerator	350
Tea strainer	326	Wine basket	350
Tea-box	272	Wine collar	350
Temaki stand	252	Wine cooler stand	348
Tempering unit	189, 471	Wine glass	294
Thai knife	123	Wine holder	350
Thermic box	439, 461	Wine stopper	305
Thermo cover	438	Wine taster	350
Thermometers	130-133	Wire grid	58
Thermoregulator	406	Wire skimmer	103
Tickets-holder	105	Wok brush	259
Tilt truck	452	Wok pan	20, 30, 40, 256
Toast rack	327	Wooden service platter	44-46
Toaster	454	Yogurt dispenser	384
Toban skillet	256	Zabaione bowl	35
Tomato cutter	115	Zaru soba tray	251
		Zucchini corer	88, 93

WYZ

A

Accessori Cucina	81-135
Acciaino	146
Accumulatore di caldo	435
Accumulatore di freddo	383, 435
Acetato in fogli	197
Adattatore induzione	470
Adattatore per bocchette	183
Affetta pomodori	115
Affettatrice	157
Affettatrice, elettrica	472
Affilacoltelli, elettrico	474
Affilacoltelli, manuale	153
Affumicatoio	459
Ago lardellare	154
Alzata	370-371, 373-375
Alzata dolci	273
Alzata girevole	328
Alzata Royale	347
Alzata torta	274-275, 400
Alzata/cesto	374
Anelli e telai per torte/mousse	197-200
Anelli per torte	197-198
Anelli per uova	117
Aperitivo/degustazione, set	329
Apparecchi elettrici	454-474
Apparecchio per cottura sottovuoto	468
Apribottiglie	88, 92
Apriscatole	88, 92, 93, 126, 128
Apriscatole, elettrico	474
Arriciaburro	89, 94
Aspirapolvere meccanico	446
Asta per mestolame	102
Asta portascontrini	105

B

Bacchette cinesi	254, 259
Bacinella per gelato	278
Bacinella tonda	111-112
Bagnomaria	23, 28, 35
Bar, Happy Hour, articoli per	283-310
Barbecue da tavola	42
Barca per sushi e sashimi	252
Barra magnetica	153
Bastardella emisferica	35
Batticarne	155-156
Benna ribaltabile	452
Bicchieri	293-295
Bicchierino degustazione	307-308
Bilance	134-135
Boccale birra	293
Bocchette	175-183
Bollitore	22
Bollitore con rubinetto	467
Bollitore uova	457
Bordatore bicchieri	301
Borsa isoterma per pizza	265
Bottiglia angostura	298-299
Bottiglia per bagne	195
Box portaghiaccio	384
Box termico	439, 461
Bruschino per bocchette	183
Buffet & Presentazione, Articoli per	362-401

C

Caffettiera pressa filtro	325
Campanella reception	353
Candeliere/Candelabro	351
Candles	378
Cannello	189
Cannoli/Cornetti	184
Cannucce	287
Cappello Chef, carta	162
Caraffa	325-326
Caraffa graduata	106
Caraffa sake	253
Caraffa termica	325, 399-400
Caramellizzatore	188
Caramellizzatore, elettrico	472
Carapina	279
Carrelli da sala	418-422
Carrello 3 piani	427
Carrello breakfast	439
Carrello di servizio	440
Carrello GN	439-441
Carrello lavapavimenti	448
Carrello multiuso	448
Carrello per cestelli	426
Carrello per derrate alimentari	431
Carrello porta ghiaccio	437
Carrello porta teglie	440-441
Carrello portabiancheria	445-446
Carrello portapiatti	438, 427
Carrello portasacco	451
Carrello Quick Cart	444
Carrello rifornimento frigobar	441
Carrello trasporto materiali	441-442
Carrello vasca	431
Carta da forno	196, 197
Cascata champagne	401
Casseruola per zabaione	35
Casseruola per zucchero	35
Casseruola terracotta	258
Cavalletto di segnalazione	448
Cavatappi	305-306
Centrifuga, elettrica	463, 465
Centrifuga, manuale	112
Ceppa	159
Ceppo porta coltelli	152-153
Cesta pane	337, 386-391
Cesta per friggere	58
Cestelli Lavabicchieri	424-425
Cestino impasto	247
Cestino rifiuti	449
Cestino vino	350
Cesto frutta	296, 336, 373
Cesto porta uova	391
Chafing-Dish	403-416
Chitarra	114, 191
Ciotola refrigerata	384, 394
Ciotola riso con coperchio	251
Ciotola/Insalatiera	249-250, 317-321, 362-372, 375
Ciotoline	252-253
Clip chiudi sacco	114
Clip porta etichette	392
Cloche	342
Cocotte per molluschi	346

Colafritto	22, 102
Colapasta	109-111, 258
Colapasta a spicchi	23
Colatutto	84, 112-113
Colatutto conico	84
Colino a rete	84, 91
Colino cocktail	290
Colino Julep	290
Collare salvagoccia	350
Colonna luminosa	401
Colonna portasecchiello	348
Coltelleria professionale & accessori	137-162
Coltelli e articoli da taglio	137-162
Coltello agrumi	89
Coltello apriostriche/cozze	86, 92
Coltello arrosto	314
Coltello decora frutta	90
Coltello formaggio	87, 91
Coltello panettone	313
Coltello per marzapane	174
Coltello per pizzaiolo	86, 264
Coltello per pompelmo	89, 93
Coltello torta	87, 98
Coltello verdure	86, 91
Compressore per penna aerografa	189, 472
Cono boston	292
Contenitore cilindrico	23
Contenitore isoterma	265, 434-437
Contenitore per alimenti	429-431, 437
Contenitore per cialde	277
Contenitore per impasti	266
Contenitore per stoviglie	428
Contenitore per uova	117
Contenitore versatore	299
Contenitori Gastronorm	50-79
Contenitori/Ceste	432-433
Coperchio roll-top	392, 394
Copertura termica	438
Coperture monouso	439
Coppa ananas	284
Coppa burro	335
Coppa caviale	347
Coppa gelato	277
Coppa margarita	284, 293, 296
Coppa punch	400
Coppa riso	249
Coppa zucca	284
Coppetta sake	253
Coppino forato	314
Coppino salsa	314
Copripiatto	106
Copriscarpe	162
Cornetto cinese	113
Couscoussiera	25
Crepiera	456-457
Cucchiari decorazione	174
Cucchiaino sale	314
Cucchiaio a servire	313
Cucchiaio assenzio	289
Cucchiaio bibita	289, 315
Cucchiaio brodo	252
Cucchiaio cinese	253
Cucchiaio finger-food	365-366
Cucchiaio ghiaccio	297, 315
Cucchiaio insalata	95

Cucchiaio magico	289	Formaggiera	341	Mantecatore per burro	124
Cucchiaio miscelatore	94, 289	Fornello crêpes suzettes	345	Marcatore pane Kaiser	247
Cucchiaio parmigiano	314	Forno microonde	468	Mestoli	82, 94, 102, 259, 314
Cucchiaio riso	95, 255, 314	Forno multifunzione	457	Mestolino salsa	94, 102
Cucchiaio salsa	315	Friggitrice	457-458	Mestolo forato	83, 100
Cucchiaio silicone	96	Frullatore	466	Mestolo unipezzo	100
Cucchiaio/Forchetta monoporzione	315	Frusta	84, 90, 96, 102, 105	Miniature	33, 36, 37
Cucchiandone	81-83, 102	G		Miscelatori cocktail	288
Cucchiandone forato	82, 95, 102	Ganci	154-155	Misurini	107
Cucchiandone unipezzo	100	Gancio appendi borsa	348	Misurino cocktail	290-291
Cucina etnica, articoli per	249-259	Gastronorm, Inox	52-60	Mixer	462
Cuociriso a vapore	467	Gastronorm, Melamina	76-77	Molla ghiaccio	297, 313
Cuocivapore	255, 257	Gastronorm, Policarbonato	61-65	Molla per asparagi	313
Cutter/tagliav verdure, elettrico	459, 463	Gastronorm, Polipropilene	69-75	Molla per frutta	312
DE		Gastronorm, Porcellana	78-81	Molla per grill	104
Decora limoni	90, 94	Gastronorm, Tritan	66-67	Molla per lumache	313
Decora verdure	122	Gel combustibile	416	Molla per zucchero	313
Densimetro per salamoia e sale	133	Gelateria, articoli per	277-281	Molla spaghetti	82, 95, 102, 312
Disidratatore	459	Girello per decorazione torte	186	Molle	82, 313
Display per buffet	372, 373	GN-teglie	56	Molle/pinze servire	82, 104, 312-314
Distributore di bevande isothermico	399, 437	Grattugia formaggio	88, 119	Mop	446-447
Distributore di cereali	383, 397-398	Grattugia per wasabi	258	Mortajo e pestello	258
Distributore di latte	399	Grattugie	92, 119, 124-125	Multi-distributore	395
Distributore di succhi	383, 398-399	Grembiule di protezione	160	NO	
Dosa caffè	93	Grembiule LDPE	162	Nastro PVC	197
Dosatore alcoolici	303-304	Griglia di colaggio	187	Nebulizzatore olio/acetato	340
Dosatore miele/cremiera	271	Griglia di raffreddamento	187	Noccioli di cottura in ceramica	197
Dosatrice per creme	188	Griglia in filo	58	Oliera	258, 261
Espositore buffet	383, 394	Griglia reversibile	41, 42, 44	Omogeneizzatore	464
Espositore buffet a scala	396	Griglie Per Decoro Biscuit	209-211	Orologio da parete	134
Espositore porta frutta	347, 400	Grill	455-456	Ossigenatore per vino	350
Espositore sacchetti/bocchette	186	Guanti	162	Oven cooking dishes, porcelain	48
Etichette dissolvibili	134	Guanti da forno	160-161	P	
F		Guanti in lattice	161	Padella balti/karahi	257
Falso fondo forato	58-70	Guanti scrub	161	Padella crêpes	346
Fascia microforata	200	Guanto anti taglio	161	Padella grill	40, 41
Fasciatoio da parete	444	Guanto in cotta di maglia	160	Padella omelette giapponese	257
Ferma prosciutto	156	IKL		Padella tawa	257
Fermatovaglia	342	Imbuto	106	Padella Toban	256
Fingerfood/Miniature	323-324	Imbuto colatore	188	Padelle ferro	30
Flacone dosatore	107-108	Impastatrice planetaria	468	Pala per patate fritte	103
Flair bottle	298	Insaccatrice verticale	157	Pala per torte	186
Flexipan	231-243	Insalatiera	336	Pala pizza	261-262, 264
Flute champagne	284, 294	Kit visitatore, TNT	162	Pala torta	95, 313
Fontana cocktails	401	Laccetti da cucina	114	Paletta	447
Forbice carni	258	Lame panettiere	247	Paletta angolare	81, 98
Forbice dolci	312	Lampada ad infrarossi	461	Paletta cenere	262
Forbice erbe	118	Lampada per zucchero	189, 471	Paletta forata	83, 95-96, 97, 102
Forbice pizza	264	Lanterne	377	Paletta forata unipezzo	101
Forbice sigari	353	Lattiera	271	Paletta fritti	82
Forbice torta	312	Lavabicchieri	303	Paletta liscia unipezzo	101
Forbice tutto servire	312	Legatovagliolo	342	Paletta silicone	96
Forbice uva	312	Levacapsule	306	Pane, Accessori per	245-247
Forbice verdure	312	Levatosoli	90, 93	Panno passabrodo	113
Forbici da cucina	149-150	Lira per pan di Spagna	190	Passapomodori	126
Forchetta a servire	313	M		Passathé	326
Forchetta insalata	94	Macchina per cialde	459	Passaverdura	126-127
Forchetta per lumache	315	Macchina per gelato	459	Passaverdura, elettrico	473
Forchettina ostriche	315	Macina Pepe/Sale	339, 355-360	Pattumiera a pedale	449, 451
Forchettine pralineria	174	Macinaerbe	126	Pedana	452
Forchettone	96, 102, 138-146, 314	Mandolino	120	Pela carote	115
Forchettone unipezzo	100			Pela mele	116

Pela/svuota ananas	116	Porta posate	341, 384, 425-426	Schiaccianoci	346
Pela/taglia avocado	118	Porta rotolo	105, 439	Schiacciapate	118
Pelapatate	89, 93, 118	Porta snack	308-310	Schiumarola	82, 95, 102-103
Pelapomodori	89	Porta yogurt	384	Schiumarola fritto	259
Pelarance	89, 93	Portabustine zucchero	272	Schiumarola unipezzo	101
Pelaspargi	89	Portacandela	352	Sciabola per Sommelier	350
Pelatrice elettrica	116	Portaciotole	394	Scolapiatti a muro	427
Pelaverdure	118	Portacombustibile	406, 415	Scopa	446
Penna a gesso liquido	392	Portacondimenti	301, 342	Secchiello vino	348-350
Penna aerografa	189	Portagiornale	378	Secchio	111
Pennello per alimenti	87, 92, 194	Portarifiuti da tavola	346	Secchio con strizzatore	449
Pennello per wok	259	Portasalatini	365	Secchio ghiaccio	297, 298, 437
Pentola cinese	258	Portaspago	156	Secchio portabottiglie	401
Pentolame, 3-Ply	19-20	Portatoast	327	Sega per ossa	156
Pentolame, Alluminio	24-28	Portatovaglioli	272-273, 342	Seggiolone	444
Pentolame, Ghisa smaltata	38-46	Portauovo	327	Segnaporzioni	193
Pentolame, Inox	8-18	Porzionatore	89, 93, 114, 279	Senapiera	335
Pentolame, Rame	33-35	Posacenera	353, 354	Separatore GN	58
Pentolame, Rame INDUZIONE	31-32	Posacenera a colonna	452	Separauova	94
Percolatore per caffè	470	Posate caviale	347	Servizio oliera	340
Pesa sciroppo (densimetro)	133, 190	Pressa-hamburger	157	Servizio raclette	345
Pesciera	22, 28, 35	Pressapatate	91	Sessola per ghiaccio	297, 437
Pestagiaccio	297	Pressapolipo	114	Sessola tonda	108
Peugeot	355-360	Presse canard	114	Set fonduta	35, 345
Piano caldo	461	Pulizia, articoli per la	444-452	Setaccio	108-109
Piastra ad induzione	404, 469	Pungisalame	153	Setaccio farina	195
Piastre elettriche	405, 416	R Raccoglibriccola	342	Setaccio per zucchero a velo	195
Piatto a servire	251	Rachie/Tagliapasta	194, 265	Setaccio rete farina	195
Piatto fondo	317, 319, 321	Rastrelliera	105, 302	Sgocciolatore stampi silicone	229
Piatto frutti di mare	347, 401	Rastrello	262	Shaker	291-292
Piatto ghisa	258	Rechaud	44, 345	Sifone nitro	270
Piatto lumache	347	Recipiente multiuso	427	Sifone panna	280
Piatto piano	252, 317, 319, 321	Retina pizza	266	Sifone soda	296
Piatto Rettangolare	317, 319	Ricambi	479-487	Silform	244-245
Piatto torta	274	Riga	190	Silpain	196
Piatto/Plancia	367, 371	Riscalda sake	253	Silpat	196
Pietanziera	437	Rompighiaccio	296	Siringa per pasticceria	185
Pietra ollare con supporto	345	Rotella taglia pasta	86, 90, 192	Snocciolatore	119-120
Pietra per affilare	146	Rotella taglia pizza	86, 90, 264	Sottopentola	40, 346
Pinza	104, 105, 289	Rotolo portacoltelli	152	Spade	154
Pinza aragosta	346	Roul'Pat	196	Spargicacao	271
Pinza champagne	350	Rullo bucasfoglia	192-194	Spargisale/pepe	339
Pinza per affettati	155	Runner	344	Spargizucchero	195, 271
Pinza per anatra	258	S Sacchetto per decorare	184-185	Spatola burro	87, 92, 314
Pinza per grill	104	Sacco vinile	445	Spatola dolce	83, 98
Pinza per teglie	264	Salinometro	133	Spatola hamburger	98
Pinza togli lische	104	Salsiera	252, 336	Spatola lasagne	98
Pirofile da forno	48	Samovar	412	Spatola pasticcio e pizza	98
Pistola elettrica	189, 471	Saponetta togli odori	94	Spatola per stemperare	81
Pizza, Accessori	260-268	Sbuccia melone	89	Spatole	81-83, 92, 95, 98, 103, 105, 259
Pizzi sottotorta	186	Sbucciatore	89, 93	Spatole crêpes	103
Placca biscotti	210-211	Scalda würstel	456	Spazzola pane	247
Pompa sottovuoto per vino	307	Scaldacaffè	412, 416, 470	Spazzola per farina	195
Pompetta con terminale in rame	190	Scaldacognac	350	Spazzola per griglia	105, 263
Pompetta per sugo	104	Scaldapiatti	458	Specchi acrilico	376-377
Porta cannuce	272, 277	Scaletta pieghevole	452	Spiedini	154, 254, 307
Porta coltelli	153	ScalPELLI ghiaccio	124	Spiedini cocktail	307
Porta coni	277-278	Scatola bento	251	Spillone portascontrini	105
Porta cucchiaini	272	Scatola portabustine thè	272	Spremiaglio	92, 119
Porta menù	352	Scavazucchine	88, 93	Spremiagrammi manuale	296
Porta oggetti da bar	298	Scavino	88, 93	Spremiagrammi, elettrico	464, 466
Porta pale pizza	263			Spremilimone	296
Porta palette	277			Squamapesce	86, 91, 259
Porta pellicola	105			Stampi Flexipan	231-243
Porta piatti	427			Stampi magnetici	218

Stampi Natale	221	Targhetta tavola	353
Stampi Pasqua	220-221	Tastevin	350
Stampi praline	213-221	Tavola, Articoli per la	312-354
Stampi, Alluminio	201	Tavolette per cioccolato	218
Stampi, Antiaderenti	203-208	Tazza julep	286
Stampi, Silicone	212, 222-229	Tazza moscow mule	284-286
Stampo cucchiaino	219	Tazza soba choko	251
Stampo ghiaccio	297	Tazzone	109-112
Stampo panzerotti	126	Tegame rettangolare	22, 27, 28, 35
Stampo per nigiri	255	Teglia forno	187, 268
Stampo per pane	246	Teglia pizza	267-268
Stampo piattino	219	Telaio torte	198-201
Stampo tazza caffè	219	Temperatrice	189, 471
Stampo uovo	219-200	Temperino per verdure	87
Stand per vassoi	378	Termometri	130-133, 190
Stazione di riciclo, kit	450	Termoregolatore	406
Stencils	212	Test degradazione oli di frittura	133
Stendipasta	190	Timer digitale	133
Sterilizzatore ad immersione	153	Tostapane	454
Sterilizzatore per coltelli	474	Tovaglette	344
Stiletto thailandese	123	Trancia spicchi	115, 117
Stiletto/Forchettine aragosta	346	Trasporto & Stoccaggio, Articoli per	424-442
Stuoietta	255	Trinciapollo	151
Stuzzicadenti	307	Tritacarne	472
Supporto	362-363	Tritagliaccio	297, 465, 467
Supporto bacchette cinesi	254		
Supporto bottiglie	303	UV	
Supporto mobile tondo	431	Utensili Cucina	81-135
Supporto numero tavola	352	Utensili Pasticceria	164-247
Supporto per temaki	252	Valigia Barman	302
Supporto per vasetti gourmet	331	Valigia cuoco	151
Supporto piatto frutti di mare	347	Vaporiera, elettrica	467
Supporto targhetta	352	Vasca riso hangiri	256
Svuota ananas	88, 116	Vasetti con coperchio	330-331
		Vaso fiori	350
T		Vaso porta sacchetto	186
Taglia ananas	116	Vaso soia	253-254
Taglia capsula	305	Vassoi/Plance	249-250, 320-321, 327-328
Taglia croissants	193	Vassoi/Plance	332-334, 364, 368-372, 378-380
Taglia cubi	115	Vassoio colazione con gambe	378
Taglia funghi	118	Vassoio conto	273
Taglia mango	118	Vassoio espositore	156, 195-196
Taglia pane	386	Vassoio Party	317, 319, 363
Taglia patate	118	Vassoio portatovagliolo	251
Taglia ricci di mare	346	Vassoio rettangolare	156
Taglia tortillas	119	Vassoio zarusoba	251
Taglia uova	117	Versavino	350
Taglia verdure Rouet	122	Vetrina brioches	273
Tagliapasta con espulsore	174	Vetrina buffet	381, 384, 392-393
Tagliapasta estensibile	192	Vetrina riscaldata	458
Tagliapasta per doughnuts	172	Vetrina sigari	353
Tagliapasta, Inox	164-172		
Tagliapasta, Pa+	173	WZ	
Tagliapaste stelle	172	Wok	20, 30, 40, 256
Tagliatartufi	338	Zuppiera	416
Tagliaverdure	90, 115, 120-121	Zuppiera testa di leone	336
Tagliere a servire in legno	44-46	Zuppiera, elettrica	470
Tagliere sushi	251		
Taglieri	158-159, 334, 391, 394		
Tappetino bar	301		
Tappeto silicone	196		
Tappo spumante	305		
Tappo versatore	304		
Tappo vino	305		

A

Abfallbehälter	449
Absinth-Löffel	289
Abstecher	265
Abtropfplatte	58-70
Abziehstein	146
Acetat Band-Blätter	197
Adapter für Spritztüllen	183
Airbrush Kompressor	189, 472
Airbrush-Pistole	189
Alkohol-Meßbecher	290-291
Allzweckwagen	448
Ananasausstecher	88, 116
Ananasschälmaschine	116
Ananasteiler	116
Apfelentkerner-/Schneider	117, 90, 93
Apfelschäler	116
Aschenbecher	353, 354
Asche-Schaufel	262
Aufhänger für Silikonbackformen	229
Aufhängungstange	102
Aufschnitt-Maschine	157
Aufschnitt-Maschine, elektrisch	472
Ausgießer	350
Auslegeplatte	195-196
Ausstechformen mit Auswerfer	174
Ausstechformen, Edelstahl Rostfrei	164-172
Ausstechformen, Pa+	173
Ausstechmatte	210-211
Ausstellplatte	156
Austerngabel/-Messer	315, 86, 92
Austernplatte	347, 401
Avocadoschäler-/Teiler	118

B

Backbleche	187, 268
Backbleche-Wagen	440-441
Bäcker-Klingen	247
Backhandschuhe	160-161
Backkerne	197
Backrahm	198-201
Backschaufel	83, 97, 101
Backtrennfolie	196, 197
Balti-Pfanne	257
Bar, Happy Hour Artikel	283-310
Bar-Behälter	298
Bar-Beilagenbehälter	301
Bar-Kombination Salz-/Zuckerumrander	301
Barman-Koffer	302
Becher Julep	286
Behälter für Pizzateig	266
Behälter, mehrzweck	427
Behälter/Körbe	23, 432-433
Bento-Box	251
Besen	446
Besteckbehälter	341, 384, 425-426
Besucher-Kits, TNT	162
Bier-Glas	293
Bitter Flasche	298-299
Blaszuckerspritze	190
Blumenvase	350
Bons-/Zettelhalter	105
Boston-Shaker	292

Bouillonstoffsieb	113
Brenngel	416
Brennstoffhalterung	406, 415
Brot, Zubehör	245-247
Brot-Ausstechforme	246
Brot-Bürste	247
Brotformen	247
Brotkorb	337, 386-391
Brotröster	454
Brotschneidergerät	386
Buffet Und Präsentation Artikel	362-401
Büffetgestell	372-373, 383, 394
Büffet-Leiter	396
Buffetvitrine	381, 384, 392-393
Butterfaß	124
Buttermesser	87, 89, 92, 94, 314
Butterservierer	335

CD

Caramelisier-Eisen	188, 472
Chafing-Dish	403-416
Champagnersäbel	350
Champagner-Zange	350
Chinesische Suppentopf	258
Cocktail Glas	295
Cocktail Rührer	288
Cocktaillöffel	94, 289
Cocktail-Sieb	290
Cocktails-Laufbrunnen	401
Cocktailspiese	307
Cognacwärmer	350
Couscoustopf	25
Crema-Dosierer	188
Crêpegerät	456-457
Crêpe-Paletten	103
Dampfer, elektrisch	467
Dampfgarer	255, 257
Dehydratisierapparat	459
Dekanter	350
Dekoration-Löffel	174
Dekoriermesser	90
Digitalkochalarm	133
Donut-Ausstecher	172
Dosenöffner	88, 92, 93, 126, 128
Dosenöffner, elektrisch	474
Dosierausgiesser	304
Dosier-Vorratsbehälter	299
Drahtlöffel	103
Drahtschneider	190
Dreieckschneidewalze	193
Dressingschöpfer	314
Drücksieb	195

E

Eierbecher	327
Eierbehälter	117
Eierkocher	457
Eierkorb	391
Eierringe	117
Eierteiler	117
Eier-Trenner	94
Eimer	111
Eimer mit Presse	449
Eimerwagen	452

Eisbecher	277
Eisbehälter	278
Eisbox	298, 384
Eisdiele	277-281
Eiseimer	297, 437
Eisenpfannen	30
Eiskugel-Former	297
Eislöffel	297, 315
Eislöffelbehälter	277
Eismaschine, elektrisch	459
Eismeissel	124
Eisportionierer	93, 279
Eisschaufel	297, 437
Eisstößel	296
Eiswaffelpender	278
Eiswaffelständer	277
Eiswagen	437
Eiswolf	297, 465, 467
Eiszange	297, 313
Eiszerstosser	297
Elektrische Geräte	454-474
Elektro-Heizelemente	405, 416
Ersatzteile	479-487
Ess-Stäbchen	254, 259
Ess-Stäbchen Ablage	254
Ethnische Küche Artikel	249-259

F

Fahrbares Tellergerüst	438
Fingerfood-Löffel	365-366
Fingerfood-Schalen	323-324
Fingerhandschuhe	160
Fischentschupper	86, 91, 259
Fischheber	82
Fischkochkessel	22, 28, 35
Flair bottle	298
Flambierpfanne	346
Flambier-Rechaud	345
Flasche zum Anfeuchten	195
Flaschenkühler-Bowle	401
Flaschenöffner	88, 92, 306
Flaschenregal	105, 302
Flaschen-Ständer	303
Fleischblech	156
Fleischgabel	96, 100, 102, 138-146, 314
Fleischhaken	154-155
Fleischschere	258
Fleischwolf	472
Flexipanbackformen	231-243
Folien-Abreißgerät	105
Folienchneider	305
Fonduegäbelchen	345
Fondue-Service	345
Fondue-Service	35, 345
Fritteuse	457-458
Frittierkorb	58, 259
Fruchtezange	312
Früchtenschneider	115
Fruchtportionierer	89
Fruchtpresse, elektrisch	463, 465
Fruchtsaft-Glas	293
Frühstück-Service-Wagen	439
Frühstückstablett mit Beinen	378

G

Gastronorm Behälter	50-79
Gastronorm-Behälter, Edelstahl Rostfrei	52-60
Gastronorm-Behälter, Melamin	76-77
Gastronorm-Behälter, Polykarbonat	61-65
Gastronorm-Behälter, Polypropylen	69-75
Gastronorm-Behälter, Porzellan	78-81
Gastronorm-Behälter, Tritan	66-67
Gastronormrost	58
Gebäcksspritze	185
Gebäckständer	273
Gebäckzange	312
Gebäkfüllmaschine	188
Geflügelschere	151
Gemüseausstecher	88, 93
Gemüse-Dekoriergerät	122
Gemüsefedermesser	87
Gemüsehobel Mandoline	120
Gemüsemesser	86, 91
Gemüseschäler	118
Gemüseschneid/- u. Schälmaschine	463
Gemüseschneider	115, 120-121
Gemüseschneider Rouet	122
Gemüseschneidmaschine, elektrisch	459
Gemüseseiher	84, 109-111
Gemüsewaschwagen	431
Geruchentferner-Seife	94
Getränkebehälter, isothermen	399, 437
Getränke-Dosierer	303-304
Getränkemixer	466
Giesslöffel	100, 102
Giesslöffel, perforiert	82, 95, 102
Gitter Für Biscuit	209-211
Gläser mit Deckel	330-331
Gläserabstellmatte	301
Gläserhalter	302
Gläserpüler	303
Gläser-Serviergestell	331
GN-Backbleche	56
Grapefruitmesser	89, 93
Grätenentkerner	104
Grillenbürste	105, 263
Grill-Pfanne	40, 41
Grill-Platte, zweiseitig	41, 42, 44
Grill-und Wurstzange	104
Guitare	114
Gusseisenplatte	258

HJ

Hackblock	159
Hamburgerpresse	157
Hamburgerspachtel	98
Handschuhe	162
Handtaschentischhänger	348
Handtuch-Tablett	251
Hangiri/Sushi-Reis-Wanne	256
Harke	262
Hochzeitstortenständer	400
Hotelwäschewagen	445-446
Hummergabel/-Zange	346
Hydrometer für Sole und Salz	133
Induktion Adapterplatte	470
Induktionsplatte	404, 469

Infrarot Wärmebrücke	461
Japanische Omelette Pfanne	257
Julep Barsieb	290

K

Kaffeebereiter	325
Kaffeedispenser	412, 416, 470
Kaffeelöffelbehälter	272
Kaffee-Perkolator	470
Kaffeetassenform	219
Kaiserbrot Stempel	247
Kakaostreuer	271
Kartenhalter	352
Kartoffelpresse	91, 118
Kartoffelschneidgerät	118
Käsedose	341
Käsemesser	87, 91
Käseraffel	88, 119
Kassenscheine-Aufstecknadel	105
Kaviar-Bestecke	347
Kaviarkühler	347
Kehrer	446
Kerzen	378
Kerzenleuchter	351
Kinderstuhl	444
Kirschenentsteiner	119-120
Knet- u. Schlagmaschine	468
Knoblauchpresse	92, 119
Knochen säge	156
Knödel-Form	126
Kocher	22
Kochgeschirr, 3-Ply	19-20
Kochgeschirr, Aluminium	24-28
Kochgeschirr, Edelstahl Rostfrei	8-18
Kochgeschirr, Gusseisen emailliert	38-46
Kochgeschirr, Kupfer	33,-35
Kochgeschirr, Kupfer INDUKTION	31-32
Kochkoffer	151
Kochmütze	162
Kochstein mit Träger	345
Kochzange	104, 105
Kontaktgrill	455-456
Korb	373, 428
Korkenzieher	305-306
Korkuntersetzer	346
Kotelettklopfer	155-156
Krake-Presse	114
Kräutermühle	126
Kräuterschere	118
Kreidestifte	392
Krümelsammler	342
Kuchenformen Mit Antihafbeschichtung	203-208
Kuchenformen, Aluminium	201
Kuchenformen, Silikon	212, 222-229
Küchenmesser & Zubehör	137-162
Kuchenpalette	83, 98
Kuchpinsel	87, 92, 194
Küchenschere	149-150
Küchensieb	84, 112-113
Küchenutensilien	81-135
Küchenwender	95, 96, 102
Kuchenzange	312
Küchenzubehör Artikel	81-135

Kugelausstecher	88, 93
Kühlakku	383, 435
Kühlschale	384, 394
Kürbis-Becher	284

LM

Lageruntersätze	452
Lasagneheber	98
Laternen	377
Leiter, klappbar	452
Lichtsäule	401
Likör- u. Fondantrichter	188
Limonadenlöffel	289, 315
Lineal	190
Löffel	81-83, 96, 253
Löffelform	219
Lösbare Etiketten	134
Magnetische Schocoladenformen	218
Magnet-Messerhalter	153
Mangoteiler	118
Margarita Glas	284, 293, 296
Martini-Glas	284, 294, 295
Marzipan-Messer	174
Maßlöffel	93
Mehlbürste	195
Mehlschaufel	108
Mehrzweckwagen	440
Melonenschäler	89
Menage	340
Messbecher	106
Messer Schleifapparat	153
Messer Und Zubehör	137-162
Messeraufhänger	153
Messerblock	152-153
Messerentkeimer	153
Messerentkeimer, elektrisch	474
Messer-Rolltasche	152
Messerschleifapparat, elektrisch	474
Messlöffel	107
Mikrowelle	468
Milchgießer	271
Milchkanne	399
Miniaturen	33, 36, 37
Mixergerät	464
Monoporzion-Gabel/-Löffel	315
Mops	446-447
Mörser und Stößel	258
Moscow Mule Becher	284-286
Mühle, Für Pfeffer U. Salz	355-360
Müllschaufel	447
Multi Rack	395
Multifunktionsofen	457
Muscheltopf	346
Müslispender	383, 397-398

NO

Nahrungsmittelbehälter, fahrbar	431
Nestbacklöffel	102
Nigiri-Ausstechform	255
Nitrobereiter	270
Nudeln-Sieb	258
Nussknacker	346
Obstkorb/Schale	296, 336
Obstständer	347, 400

Ofenpfanne, rechteckig	22, 27, 28, 35	Roul'Pat	196	Servierlöffel	313
Ofenschalen, Porzellan	48	Rührbesen	84, 90, 96, 102, 105	Servierplatte, drehbar	328
Öl-/Essigvernebler	340	Rührglas	293	Servierwagen, dining-room service	418-422
Olivenentsteiner	119-120	Rühr-u. Temperierlöffel	81	Servierzange	82, 104, 312-314
Ölkanne	258, 261	Runner	344	Serviettenring/-halter	272-273, 342
Orangenpresse	296	S		Shaker	291-292
Orangenschäler	89, 93	Sackhalterwagen	451	Sieb	108-109
Ostereierform	219-200	Saftdispenser	383, 398-399	Sieb für Mehl u. Puderzucker	195
Osternformen	220-221	Saftkanne	326	Silform	244-245
PQ		Saft-Spritze	104	Silikonbackmatte	196
Palette aus Silikon	96	Sahne-/Honigkännchen	271	Silikonbänder	114
Parmesanlöffel	314	Sahnebereiter	280	Silpain	196
Party Platte	317, 319, 363	Sahnerolle	184	Silpat	196
Passiergerät	126-127	Sakebecher	253	Sirup-Hydrometer	133, 190
Passiergerät, elektrisch	473	Sakekrug	253	Snack-Behälter	308-310
Patisseriezubehör	164-247	Sakewärmer	253	Soba Choko-Schale	251
Pedaleimer	449, 451	Salad-/Gemüsezange	312	Soda Siphon	296
Pendelschäler	93	Salamistachel	153	Sojakrug	253-254
Permanentausgiesser	304	Salatlöffel	95	Sous-Vide Garer	468
Peugeot	355-360	Salatschleuder	112	Spaghettizange	82, 95, 102, 312
Pfeffermühle Mühle	339	Salatschüssel	336	Spargelschäler	89
Pilze-Teiler	118	Salz-/Pfefferstreuer	339	Spargelzange	313
Pizza, Zubehör	260-268	Salzgebäckständer	365	Sparschäler	89, 93, 118
Pizzablech	267-268	Salzgehalt-Meter	133	Speiseglocke	342
Pizzablech-Zange	264	Salzlöffel	314	Speisekartenhalter	352
Pizzamesser	86, 264	Salzmühle	339	Speisenbehälter	437
Pizzanetzscheibe	266	Samovar	412	Speisen-Kaste	439, 461
Pizza-Rad	86, 90, 264	Saucenlöffel	94, 102, 315	Speisenwärmer	44, 345
Pizzaschaufel	261-262, 264	Sauciere	252, 336	Spicknadel	154
Pizzaschere	264	Schale/Schüssel	249-250, 252-253, 317-321, 362-372, 375	Spiegel	376-377
Pizzawender	98	Schalenshalter	394	Spieße	154, 254, 307
Platte rechteckig	317, 319	Schäler	89, 93, 115	Spitzsieb	113
Platte/Teller	367, 371	Schälmaschine, elektr.	116	Spritzbeutel	184-185
Plattformwagen	441-442	Schaumlöffel	82, 95, 101, 102, 259	Spritzbeutel-/ u. Tüllenaufhänger	186
Pommes-Frites-Seiher	22	Schildhalter	392	Spritzbeutel-Absetzständer	186
Pralinen Gabelchen	174	Schinkenhalter	156	Sprühpistole, elektrisch	189, 471
Pralinenform	213-221	Schinkenzange	155	Spülmaschinenkörbe	424-425
Praliné-Schneideapparat	191	Schlagschüssel	109-112	Stabmixer	462
Präzisionswaage	134-135	Schneckenabel u. Zange	313, 315	Standascher/Abfalleimer	452
Presse canard	114	Schneckenplatte	347	Ständer	370-371, 373-375
Punchbowle	400	Schneebeesen	84	Ständer für Schaufeln	263
PVC Band	197	Schneeschlackessel	35	Ständer für Weinkühler	348
Quetschflasche	107-108	Schneidebrett	391, 394	Ständer/Korb	374
Quick Cart-Wagen	444	Schnittschutz-Handschuh	161	Stege-Adapter/Zwischensteg	58
R		Schnurrulle-Halter	156	Stencils	212
Raclette-Service	345	Schokoladentafelform	218	Stipprolle	192
Raffel	92, 119, 124-125	Schöpflöffel	82, 94, 102, 259, 314	Strohhalmbehälter	272, 277
Räucherofen	459	Schöpflöffel, gelocht	83, 100	Strohhalme	287
Receptionsschell	353	Schrubben Handschuhe	161	Suppenkessel	416
Rechaud	458	Schüssel	111-112	Suppenlöffel	252
Rechnungstablett	273	Schutzhüllen	439	Suppensieb	84, 91
Recyclingstation	450	Schutzschürze	160, 162	Suppentasse Löwenkopf	336
Reinigungsartikel	444-452	Schwerter	154	Suppenwärmer, elektrisch	470
Reinigungswagen	448	Seeigel-Messer	346	Sushibrett	251
Reiskocher	467	Seiher-Einsatz	23	Sushi-Matte	255
Reislöffel	95, 255, 314	Sekt Wasserfall	401	Sushi-Sashimi-Boot	252
Reis-Portionierer	114	Sektflaschenstopfen	305	Sushi-Servierteller	251
Reisschüssel	251	Sekt-Glas	284, 294	T	
Reistasse	249	Senfschale	335	Tablett/Platte	249-250, 320-321, 327-328
Rollenhalter	105, 439	Servier-Brett	334	Tablett/Platte	332-334, 364, 368-372, 378-380
Rolltophaube	392, 394	Serviergabel	313	Tablett-Träger	378
Rollwalze	193-194	Serviergestell	362-363	Tawa-Eisenpfanne	257
		Servier-Holzbrett	44-46	Teebox	272

Teesieb	326	Vitrine für Brioches	273
Teig-Glätter	190	Vorratsdosen	429-431, 437
Teigrad	86, 90, 192		
Teigschäber	81-83, 92, 95, 98, 103, 105, 194, 259, 265	W	
Teigschneider	192	Waffelbehälter	277
Teller flach	252, 317, 319, 321	Waffeleisen	459
Teller tief	317, 319, 321	Wagen	431
Tellergestell	427	Wagen für GN-Behälter	439-441
Tellerglocke	106	Wagen für Minibar-Versorgung	441
Teller-Transportwagen	427	Wand-Trockengestell	427
Temaki-Ständer	252	Wanduhr	134
Temperierungsmaschine	189, 471	Wärmepistole	189
Thai-Messer	123	Wärmeplatte	461
Thermischetasche für Pizza	265	Wärmespeicher	435
Thermobehälter	265, 434-437	Warmhalte-Vitrine	458
Thermo-Hülle	438	Warnschild	448
Thermokanne	325	Wasabi-Raffel	258
Thermometer	130-133	Wasserbadkasserolle	23, 28, 35
Thermopumpkanne	399-400	Wasser-Kessel	467
Thermoregler	406	Wasserkrug	325-326
Tischaufsteller	353	Weihnachtsformen	221
Tisch-Caddy	342	Weinflaschenstopfen	305
Tischeimer	346	Weingestell	350
Tischgrillplatte	42	Weinkorb	350
Tischnummerständer	352	Weinkühler	348-350
Tischservice	312-354	Weinprobenschale	350
Tischset	344	Wein-Vakuum-Pumpe	307
Tischtuch Klammer	342	Wellenschneider	90
Toastständer	327	Wetzstahl	146
Toban-Pfanne	256	Windeln-Tisch	444
Tomatenpassiergerät	126	Windlicht	352
Tomatenschäler	89	Winkelpalette	81, 98
Tomatenschneidgerät	115	Wischmop	446
Tontopf	258	Wok	20, 30, 40, 256
Tortendrehscheibe	186	Wok-Pinsel	259
Tortengitter	187	Würfel-Schneidgerät	115
Tortenheber	95	Würstchenwärmer	456
Tortenmesser	87, 98, 313	Wurstfüller	157
Tortenplatte	274-275		
Tortenringe	197-200	YZ	
Tortenschaufel	186	Yogurt-Ständer	384
Tortenspitzen	186	Zabaionekasserolle	35
Tortenteiler	193	Zahnstocher	307
Tortillasteiler	119	Zangen	82, 289, 313
Tranchierbrett	158-159	Zaru Soba-Tablett	251
Transport & Lagerung Artikel	424-442	Zauberlöffel	289
Transportwagen für Spülmaschinenkörbe	426	Zeitungshalter	378
Traubenscher	312	Zesteur	90, 94
Trichter	106	Zigarrenschere	353
Trinkbecher	294-295	Zigarren-Vitrine	353
Tropfenfänger	350	Zimtstern-Ausstecher	172
Trüffelschneider	338	Zitronenpresse	296
Tüllen	175-183	Zitrus-Messer	89
Tüllen-Bürste	183	Zitruspresse, elektrisch	464, 466
		Zucker-Handschuhe	161
UV		Zuckerlampe	189, 471
Überschuhe	162	Zuckerpfännchen	35
Überziehgitter	187	Zuckerstreuer	195, 271
Untersetzer, magnetisch	40	Zuckerthermometer	190
Untertassenform	219	Zuckertütenschale	272
Verkostung Gläser	307-308	Zuckerzange	313
Verkostung/Dessert Set	329		
Verschluss-Clip	114		
Vinyl-Sack	445		

A		
Accessoires de cuisine	81-135	
Accumulateur de chaleur	435	
Adaptateur à douilles	183	
Aérographe	189	
Affûteur manuel	153	
Agitateurs cocktails	288	
Aiguiseur, électrique	474	
Aplatisseur	155-156	
Appareil à couper les pralinés	191	
Appareils électriques	454-474	
Araignée	103	
Armoire de stérilisation, électrique	474	
Assiette creuse	317, 319, 321	
Assiette plate	252, 317, 319, 321	
Assiette rectangulaire	317, 319	
B		
Bacs Gastronomique	50-79	
Bacs Gastronomique, Inox	52-60	
Bacs Gastronomique, Melamine	76-77	
Bacs Gastronomique, Polycarbonate	61-65	
Bacs Gastronomique, Polypropylène	69-75	
Bacs Gastronomique, Porcelaine	78-81	
Bacs Gastronomique, Tritan	66-67	
Baguettes chinoises	254, 259	
Bahut	23	
Bain-marie	23, 28, 35	
Balai	446	
Balances	134-135	
Bandes à tarte	198-201	
Banneton	247	
Bar, Happy Hour	283-310	
Baratte à beurre	124	
Barbecue de table	42	
Barrette de composition	58	
Bassine	35, 109-112	
Bateau sushi et sashimi	252	
Batteries De Cuisine, 3-Ply	19-20	
Batteries De Cuisine, Aluminium	24-28	
Batteries De Cuisine, Cuivre	33, 35	
Batteries De Cuisine, Cuivre INDUCTION	31-32	
Batteries De Cuisine, Fonte	38-46	
Batteries De Cuisine, Inox	8-18	
Batteur-mélangeur	468	
Benne	452	
Billot	159	
Bloc à couteaux	152-153	
Boîte à bento	251	
Boîte à condiments	301	
Boîte à glaçons	384	
Boîte à sachets de thé	272	
Bol à riz	249, 251	
Bol réfrigérée	384, 394	
Bol soba choko	251	
Bol/Saladier	249-250, 317-321, 362-372, 375	
Bouchon à bouteille verseuse	301	
Bouchon à champagne	305	
Bouchon à vin	305	
Bouchon verseur	304	
Bougeoir	352	
Bougies	378	
Bouilloire à sifflet	22	
Bouteille à puncher	195	
Bouteille verseuse	299	
Boutique glace	277-281	
Brochettes	154, 254, 307	
Brosse à douilles	183	
Brosse à grille	105, 263	
Brosse à pain	247	
Brosse à pétrin	195	
Brosse lave-verres	303	
Brosser pour grille	263	
Broyer à glace	297, 465, 467	
Buffet Et Présentation	362-401	
C		
Caddy de table	342	
Cafetière à piston	325	
Caisson thermique	439, 461	
Canne à journaux	378	
Canneleur	90, 94	
Carafe à décanter	350	
Carafe à jus de fruits	326	
Carafe à sake	253	
Carafe soja sauce	253-254	
Caraméliseur, électrique	472	
Cartouche eutectique	383, 435	
Cascade à champagne	401	
Casiers à vaisselle	424-425	
Casse-glace	296	
Casse-noix	346	
Casserole coquillage	346	
Cendrier	353, 354, 452	
Centrifugeur/presse agrumes, électrique	463, 465	
Cercles à entremet/tarte	197-200	
Chafing-Dish	403-416	
Chaise d'enfant	444	
Chalumeau de cuisine	189	
Chandelier	351	
Chariot	431	
Chariot à 3 étages	427	
Chariot à évier	431	
Chariot à glace	437	
Chariot d'étage à linge	445-446	
Chariot de ménage	448	
Chariot de service	440	
Chariot de transport/stockage	431, 441-442	
Chariot GN	439-441	
Chariot mini-bar	441	
Chariot multi-usage	448	
Chariot petit déjeuner	439	
Chariot porte-assiettes	427, 438	
Chariot porte-sac	451	
Chariot pour casiers à vaisselle	426	
Chariot pour plaques	440-441	
Chariot Quick Cart	444	
Chariots, dining-room service	418-422	
Chauffe-eau	467	
Chauffe-plats	44, 345, 458	
Chauffe-saucisses	456	
Ciseaux à cigares	353	
Ciseaux à glace	124	
Ciseaux à herbes	118	
Ciseaux à pizza	264	
Ciseaux à rasin	312	
Ciseaux cuisine	149-150	
Clip ferme sachet	114	
Cloche	106, 342	
Collecteur	449	
Collier anti-gouttes	350	
Compresseur	189, 472	
Conteneur à snack	308-310	
Conteneur à sucre	272	
Conteneur isotherme	265, 434-437	
Conteneur multiservice	427	
Conteneur pour aliments	429-431, 437	
Conteneurs/Paniers	432-433	
Coquetier	327	
Corbeille à pain	337, 386-391	
Corps de chauffe électriques	405, 416	
Coupe à beurre	335	
Coupe à glace	277	
Coupe à sake	253	
Coupe légumes Rouet	122	
Coupe lyonnaise	30	
Coupe mangue	118	
Coupe oursin	346	
Coupe volailles	151	
Coupe-ananas en rondelle	116	
Coupe-capsules	305	
Coupe-croissants	193	
Coupe-cubes	115	
Coupe-donuts	172	
Coupe-étoiles	172	
Coupe-frites	118	
Coupe-fruits	115	
Coupe-lanières	120-121	
Coupe-pain	386	
Coupe-tomates	115	
Coupe-tortillas	119	
Coupe-truffes	338	
Couscoussier	25	
Couteau à agrumes	89	
Couteau à beurre	89, 94	
Couteau à crudités	86, 91	
Couteau à fromage	87, 91	
Couteau à gâteau	313	
Couteau à gâteau	87, 98	
Couteau à huîtres	86, 92	
Couteau à pamplemousse	89, 93	
Couteau à pâte d'amande	174	
Couteau à pizza	86, 264	
Couteau à rôtis	314	
Couteaux Et Accessoires	137-162	
Couvercle roll-top	392, 394	
Couverts à caviar	347	
Crêpière	456-457	
Crochet de table	348	
Crochets	154-155	
Crûche à eau	325-326	
Cuiller	365-366	
Cuiller à fruits	89	
Cuiller à parmesan	314	
Cuiller à riz	95, 255, 314	
Cuiller à salade	95	
Cuiller à sel	314	
Cuiller à servir	313	
Cuiller à soupe	252	
Cuiller d'absinthe	289	
Cuiller en silicone	96	
Cuillère	81-83, 102	

Cuillère à cocktail	94, 289	Epées	154	Housses usage unique	439
Cuillère à glace	93, 279, 297, 315	Epluche-ananas	116	Huilière	258, 261
Cuillère à mesure	93	Eplucheur	89, 93, 115, 118	Incisette boulanger	247
Cuillère à sauce	315	Eplucheur électrique	116	Kit visiteur, TNT	162
Cuillère à soda	289, 315	Escalier à buffet	396	LM	
Cuillère chinoise	253	Essoreuse à salade	112	Lacets de cuisson	114
Cuillère monobloc	100	Etagère à bols	394	Lampe à sucre	189, 471
Cuillère parisienne	88, 93	Etagère à buffet	372-373, 381, 384, 392-393	Lampe infrarouge	461
Cuillère perforée	82, 95, 102	Etagère à fruits	347, 400	Lanternes	377
Cuillère/Fourchette monoportion	315	Etagère Royale	347	Lardoire à clapet	154
Cuillères à mesurer	107	Etamine passe-bouillon	113	Lisse-pâte	190
Cuillères pour décorer	174	Etiquettes solubles	134	Louche à sauce	94, 102, 314
Cuiseur à oeuf	457	F		Louche perforée	83, 100
Cuiseur à vapeur	257	Fer à caraméliser	188	Louches	82, 94, 102, 259, 314
Cuiseur bain marie	468	Feuilles de cuisson	196, 197	Lyre à genoise	190
Cuisine ethnique	249-259	Feuilles en acétate	197	Machine à glace, électrique	459
Cuit riz	467	Fingerfood	323-324	Machine à tourner les légumes	115
Cuit vapeur, électrique	467	Flacon doseur	107-108	Mallette de barman	302
Cure-dents	307	Flair bottle	298	Mallette de chef	151
Curette à homard	346	Flexipan	231-243	Mandoline	120
Curettes à fondue	345	Flûte	284, 294	Marche-pied pliable	452
Cutter à légumes, électrique	459	Fonduise à fromage	345	Marmite à soupe	416
Cutter/Coupe-légumes, électrique	463	Fontaine à cocktails	401	Marmite à soupe, électrique	470
Cuve à riz sushi/hangiri	256	Fouet	84, 90, 96, 102, 105	Marmite chinoise	258
D		Fouet à blancs	84	Ménagère	340
Dash bottle	298-299	Fouet plat à spirales	289	Mesureur de cocktail	290-291
Décapsuleur	88, 92, 306	Four à micro-ondes	468	Miniatures	33, 36, 37
Decò à légumes	122	Four multifonctions	457	Minuterie digitale	133
Découpoir à lame ondulée	90	Fourchette	95	Miroirs	376-377
Découpoir à pain	246	Fourchette à escargots	315	Mixeur	462, 466
Découpoirs, Inox	164-172	Fourchette à huîtres	315	Mortier et pilon	258
Découpoirs, Pa+	173	Fourchette à salade	94	Mouffes de défournement	160-161
Dégustation/dessert, set	329	Fourchette à servir	313	Moule à chausson	126
Dénoyauteur	119-120	Fourchette diapason	96, 102, 138-146, 314	Moule à cuillère	219
Densimètre pour saumure et sel	133	Fourchette, monobloc	100	Moule à nigiri	255
Denteleur	90	Franges	446-447	Moule à oeuf	219-200
Dentelles	186	Friteuse	457-458	Moule à steak	157
Dérouleur de film/papier	105, 439	Fromagère	341	Moule pour boules de glace	297
Déshydrateur	459	Fumoir	459	Moules à chocolat	213-221
Disque relais pour induction	470	Fusil à affûter	146	Moules avec revêtement anti-adhésif	203-208
Distributeur à buffet	395	GHIK		Moules de Noel	221
Distributeur à céréales	383, 397-398	Gants	160-162	Moules de Pâques	220-221
Distributeur à jus	383, 398-399	Gaufrier	459	Moules en aluminium	201
Distributeur à lait	399	Gel combustible	416	Moules en silicone	212, 222-229
Distributeur de boissons isothermique	399, 437	Glacière à sucre	195	Moules Flexipan	231-243
Diviseur à tarte	193	GN-plaques	56	Moules magnétiques	218
Doseur	303-304	Gobelet	294-295	Moulin	126-127
Doseur à crème	188	Gobelet ananas	284	Moulin à tomates	126
Doseur pour miel/lait	271	Gobelet citrouille	284	Moulin fines herbes	126
Douilles	175-183	Gobelet julep	286	Moulin, électrique	473
E		Gobelet moscow mule	284-286	Moulins poivre/sel	339, 355-360
Ebauchoirs à tremper	174	Gril reversible	41, 42, 44	Moutardier	335
Ecailleur à poisson	86, 91, 259	Grill de contact	455-456	NOP	
Ecumoire	82, 95, 101-102, 259	Grille	58	Natte à rouler les sushis	255
Egouttoir à friture	22	Grille à glacer	187	Nébuliseur huile/vinaigre	340
Egouttoir mural	427	Grille ronde à tourte	187	Nettoyage, produits pour	444-452
Emportes-pièces	174	Grilles pour biscuit	209-211	Nid à friture	102
Empreinte pain Kaiser	247	Gueridon pâtissier	274-275	Noyaux de cuisson	197
Emulsionneur-mixer	464	Guéridon plaque tournante	186	Ouvre-boîte, électrique	474
Entonnoir	106	Guitare	114	Ouvre-boîtes	88, 92, 93, 126, 128
Entonnoir à crème	188	Hachoir	472	Pailles	287
Entonnoir à fondant	188	Horloge à paroi	134	Pain, Accessoires	245-247

Palette à hamburger	98	Pistolet	471	Pot à lait	271
Palette à lasagne	98	Pistolet électrique	189	Pot d'argile	258
Palette à pâtissier	83, 98	Pizza, Accessoires	260-268	Pot isotherme	325
Palette à pizza	98	Planche à découper	158-159, 391, 394	Poubelle à pédale	449, 451
Palettes	452	Planche à sushi	251	Poubelle de table	346
Panier	373, 428	Planche de service	334	Poussoir manuel vertical	157
Panier à frire	58	Planches à servir en bois	44-46	Présentoir	362-363, 383, 394
Panier à fruits	296, 336	Plaque à cuisson	187, 268	Présentoir à verres gourmet	331
Panier à oeufs	391	Plaque à induction	404, 469	Présentoir de bar	298
Panier à vin	350	Plaque à pizza	267-268	Présentoir tournant	328
Panier de friture	259	Plaque chauffante	461	Presse à canard	114
Panier vapeur	255, 257	Plaque coupe biscuits	210-211	Presse à pouルpe	114
Panneau d'avertissement	448	Plaque/Assiette	367, 371	Presse agrumes	296
Passe-bouillon	84, 91	Plaquette de table	353	Presse agrumes, électrique	464, 466
Passoire	84, 112-113, 258	Plat à escargots	347	Presse ail	92, 119
Passoire à cocktail	290	Plat à four	22, 27, 28, 35	Presse citron	296
Passoire à légumes	84, 109-111	Plat à huîtres	347, 401	Presse purée	91, 118
Passoire à thé	326	Plat à sushi	251	R	
Passoire chinois	113	Plat boucher	156	Rack à bouteilles	105, 302
Passoire cuit-pâtes	23	Plat en fonte	258	Rack à verres	302
Pèle et tranche avocat	118	Plat gâteau	274	Raclettes	194, 265
Pèle-pommes	116	Plat pâtissier	195-196	Rafrâichisseur à bouteilles	400
Pelle à cendres	262	Plateau	156, 249-250, 320-321, 327-328	Rafrâichisseur à caviar	347
Pelle à farine	108	Plateau	332-334, 364, 368-372, 378-380	Rafrâichissoir à yogurt	384
Pelle à frites/friture	82, 103	Plateau à serviette	251	Ramasse miettes	342
Pelle à gâteau	95, 313	Plateau double fond perforé	58-70	Râpe	92, 119
Pelle à glace	297, 437	Plateau Party	317, 319, 363	Râpe à fromage	88, 119
Pelle à pizza	261-262, 264	Plateau petit déjeuner avec jambes	378	Rape à wasabi	258
Pelle à poussière	447	Plateau porte-monnaie	273	Râpes	124-125
Pelle à tarte	186	Plateau zaru soba	251	Râteau	262
Pelle ajourée	95, 96, 102	Plats à four en porcelaine	48	Rateau à crêpes	103
Pelle en silicone	96	Poêle à crêpes	346	Réchaud à café	412, 416, 470
Percolateur à café	470	Poêle à omelettes japonais	257	Réchaud à cognac	350
Pèse-sirop	133, 190	Poêle balti	257	Réchaud à flamber	345
Petite assiette	252-253	Poêle gril	40, 41	Réchaud à sake	253
Peugeot	355-360	Poêle tawa	257	Réceptient à couverts	341, 384, 425-426
Pic à glace	297	Poêle toban	256	Réceptient à glace	278
Pichet gradué	106	Poelon à sucre	35	Réceptient à pétrissage	266
Pièces de rechange	479-487	Poelon à zabaione	35	Règle	190
Pierre à aiguiser	146	Poire à sucre soufflé	190	Ronds à oeufs	117
Pierre à cuire avec support	345	Poissonnière	22, 28, 35	Rouleau	193-194
Pince	104, 105, 289	Pompe à jus	104	Rouleau à couteaux	152
Pince à grill	104	Pompe à vide d'air	307	Rouleau à fromage	184
Pince à arêtes	104	Porte brûleur	406, 415	Rouleau extensible	192
Pince à asperges	313	Porte chalumeaux	272, 277	Roulette à pâte/pizza	86, 90, 192, 264
Pince à canard	258	Porte cornets à glace	277	Roul'Pat	196
Pince à champagne	350	Porte cuillères	272, 277	Ruban pâtissier en PVC	197
Pince à escargots	313	Porte gaufres	277	Runner	344
Pince à fruits	312	Porte plateaux	378		
Pince à glace	297, 313	Porte rolls sur socle	156	S	
Pince à homard	346	Porte serviettes	272-273, 342	Sabra à champagne	350
Pince à jambon	155	Porte-appetizers	365	Sac à dresser	184-185
Pince à plaques	264	Porte-assiettes	427	Sac en vinyle	445
Pince à saucisses	104	Porte-bouteille	350	Sac thermique à pizza	265
Pince à servir	82, 104, 312-314	Porte-cartes	352	Saladier	336
Pince à spaghetti	82, 95, 102, 312	Porte-cornets	278	Salière/poivrier	339
Pince à sucre	313	Porte-couteaux magnetic	153	Samovar	412
Pince à tarte	312	Porte-étiquettes avec clip	392	Saucière	252, 336
Pinceaux à pâtissier	87, 92, 194	Porte-fiches à billes	105	Saupoudreuse à cacao	271
Pinceaux à wok	259	Porte-manger	437	Savonnette enlève odeurs	94
Pinces	82, 313	Porte-menu	352	Scie à os	156
Pinces à nappe	342	Porte-oeufs	117	Seau	111
Pique saucisson	153	Portionneur	114	Seau à glace	297, 437
Pique-addition	105	Pose baguettes	254		
Pique-pâte	192	Pot à air isothermique	399-400		

Seau à glaçons	298	Tastevin	350
Seau à vin	348-350	Tempereuse	189, 471
Seau avec essoreur	449	Test des huiles	133
Séchoir à moules silicone	229	Testeur de salinite	133
Séchoir à poche et douilles	186	Thermo-housse	438
Sépare oeufs	94	Thermomètre à sucre	190
Seringue à biscuits	185	Thermomètres	130-133
Service à fondue	35, 345	Thermoplongeur	469
Service de table	312-354	Thermorégulateur	406
Serviteur muet	273	Tire-bouchon	305-306
Set de table	344	Toaster	454
Shaker	291-292	Toile à pizza	266
Shaker boston	292	Toque papier	162
Silform	244-245	Tranche-champignons	118
Silpain	196	Tranche-oeufs	117
Silpat	196	Trancheur	157
Siphon à crème	280	Trancheur, électrique	472
Siphon à eau de seltz	296	Transport & Stockage	424-442
Siphon à nitro	270	Tringle de cuisine	102
Socle lumineux	401		
Sonette de réception	353		
Soupière tête de lion	336		
Sous-plat	40, 346		
Spatule à délayer	81		
Spatule angulaire	81, 98		
Spatule monobloc	101		
Spatule perforée	83, 97		
Spatule perforée monobloc	101		
Spatules	81-83, 92, 95, 98, 103, 105, 259		
Station de recyclage, kit	450		
Stencils	212		
Stérilisateur à couteaux	153		
Stylet thaï	123		
Stylo à craie liquide	392		
Sucrier	271		
Support	370-371, 373-375		
Support à couteaux	153		
Support à poches	186		
Support numéro de table	352		
Support plat à huîtres	347		
Support pour bouteilles	303		
Support pour pelles à pizza	263		
Support pour temaki	252		
Support pour toast	327		
Support seau à champagne	348		
Support tourte de mariage	400		
Support/panier	374		
Sur-chaussures	162		
Système de givrage de verres	301		

Uvw

Ustensiles De Cuisine	81-135
Ustensiles De Pâtisserie	164-247
Vase à fleurs	350
Verre à bière	293
Verre à cocktail	295
Verre mélangeur	293
Verres	296-296
Verres dégustation	307-308
Verrines avec couvercle	330-331
Verseur	350
Vide ananas	88, 116
Vide courgettes	88, 93
Vide pomme	117, 90, 93
Vitrine à cigares	353
Vitrine brioches	273
Vitrine chauffante	458
Wok	20, 30, 40, 256

T

Table à langer	444
Tablettes chocolat	218
Tablier de protection	160
Tablier, LDPE	162
Taille crayon légumes	87
Tamis	108-109
Tamis à sucre glace	195
Tamis cocktail Julep	290
Tamis pour farine	195
Tamiseur farine	195
Tapis à verres	301
Tapis de cuisson en silicone	196
Tarnineur	87, 92

A

Abrebotellas 88, 92, 306
 Abrelatas 88, 92, 93, 126, 128
 Abrelatas, eléctrico 474
 Accesorios De Cocina 81-135
 Acumulador de calor 435
 Adaptador 58
 Adaptador para boquillas 183
 Adaptador para inducción 470
 Aerógrafo 189
 Aerómetro 133, 190
 Afilador 146, 153
 Afilador para vegetales 87
 Afilador, eléctrico 474
 Agitadores cócteles 288
 Aguja con clip 154
 Ahumador 459
 Alcuza 258, 261
 Anillo anti-goteo 350
 Anillo para tartas 197-200
 Anillos para huevos 117
 Aparatos eléctricos 454-474
 Aplasta carne 155-156
 Araña 103
 Asta para utensilios 102

B

Balanzas 134-135
 Bancada 452
 Bandeja cuentas 273
 Bandeja desayuno con patas 378
 Bandeja expositora 156
 Bandeja party 317, 319, 363
 Bandeja pastelería 195-196, 274
 Bandeja rectangular 156
 Bandeja servilleta 251
 Bandeja zaru soba 251
 Bandeja/Placa 249-250, 320-321, 327-328
 Bandeja/Placa 332-334, 364, 368-372, 378-380
 Baño maría 23, 28, 35
 Bar, Happy Hour 283-310
 Barco sushi-sashimi 252
 Barra de notas 105
 Barra magnética portas cuchillos 153
 Barril arroz sushi/hangiri 256
 Baterías De Cocina, 3-Ply 19-20
 Baterías De Cocina, Aluminio 24-28
 Baterías De Cocina, Cobre 33,-35
 Baterías De Cocina, Cobre INDUCCIÓN 31-32
 Baterías De Cocina, Hierro Fundido esmaltado 38-46
 Baterías De Cocina, Inox 8-18
 Batidor 84, 90, 96, 102, 105
 Batidora de vaso 466
 Batidora planetaria 468
 Blondas 186
 Bloque portacuchillos 152-153
 Bol arroz 251
 Bol para ensalada 336
 Bol refrigerda 384, 394
 Bol/Bol Ensalada 249-250, 317-321, 362-372, 375
 Bolsa de vinilo 445
 Bolsa porta cuchillos 152
 Bolsa térmica para pizza 265

Bomba para jugo 104
 Bomba vacío vino 307
 Boquillas 175-183
 Botella angosturra 298-299
 Botella para bañar 195
 Brazo triturador 462
 Buffet Y Presentación 362-401

C

Cacerola para azúcar 35
 Cacerola para mejillones 346
 Cacerola sabayón 35
 Cacillo monobloc 100
 Cacillo perforado 83, 100
 Cacillo salsa 94, 102, 314
 Caddy de mesa 342
 Caja bento 251
 Caja condimentos 301
 Caja para bolsitas de tè 272
 Cajón térmico 439, 461
 Caldera para huevos 457
 Caldero 35, 109-112
 Calentador brandy 350
 Calentador de café 412, 416, 470
 Calentador de platos 44, 345, 458
 Calentador de sake 253
 Calentador de salchichas 456
 Calentador para flambear 345
 Calentadores eléctricos 405, 416
 Campana roll-top 392, 394
 Candelabro 351
 Carretilla para cestas vajilla 426
 Carretilla Quick Cart 444
 Carrito para almacenaje de platos 438
 Carrito para desocupar 440
 Carrito plegable 452
 Carro 3 pisos 427
 Carro con prensa escurridora 448
 Carro de limpieza 448
 Carro de recogida de ropa 445-446
 Carro desayuno 439
 Carro GN 439-441
 Carro hielo 437
 Carro para hortalizas 431
 Carro porta placas 440-441
 Carro porta platos 427
 Carro servicio minibar 441
 Carro-cuba lavado verduras 431
 Carros, dining-room service 418-422
 Cascada champaña 401
 Cascanueces 346
 Catador del vino 350
 Cazos 82, 94, 102, 259, 314
 Cedazo para azúcar glas 195
 Cedazo para harina 195
 Cenicero 353, 354, 452
 Centrifugadora de ensalada 112
 Centrifugadora/exprimidor jugos, eléctrica 463, 465
 Ceba 159
 Cepillo lavavasos 303
 Cepillo para barbacoa 105
 Cepillo para boquillas 183
 Cepillo para harina 195
 Cepillo para pan 247

Cepillo para parrilla 263
 Cernidor 108-109
 Cesta 373
 Cesta escurrefrito 58
 Cesta frutas 296, 336
 Cesta pan 337, 386-391
 Cesta para botella 350
 Cesta para freír 259
 Cesta para huevos 391
 Cestas para vajilla 424-425
 Chafing-Dish 403-416
 Cinseles para hielo 124
 Cocina étnica 249-259
 Coctelera 291-292
 Colador 23, 84, 109-113, 258
 Colador a red 84, 91
 Colador chino 113
 Colador cóctel 290
 Colador cónico 84
 Colador de tè 326
 Colector a pedal 449, 451
 Colgador de bolso 348
 Columna luminosa 401
 Combustible gel 416
 Compresor 189, 472
 Conjunto visitador, TNT 162
 Contenedor 428
 Contenedor cilíndrico 23
 Contenedor comida 437
 Contenedor cuciaritas 277
 Contenedor isotérmico 265, 434-437
 Contenedor multipropósito 427
 Contenedor para alimentos 429-431, 437
 Contenedor para combustible 406, 415
 Contenedor para cubiertos 341, 384, 425-426
 Contenedor para huevos 117
 Contenedor para masa de pizza 266
 Contenedor para snack 308-310
 Contenedor para waffles 277
 Contenedor sobres azúcar 272
 Contenedores/Cestas 432-433
 Controlador de aceite de frituras 133
 Copa arroz 249
 Copa caviar 347
 Copa champán 284, 294
 Copa helado 277
 Copa mantequilla 335
 Copa margarita 284, 293, 296
 Copa martini 284, 294, 295
 Copa sake 253
 Corta tortillas 119
 Corta trufa 338
 Cortacápsulas 305
 Cortadonuts 172
 Cortador bolas 88, 93
 Cortador de erizo de mar 346
 Cortador de hongas 118
 Cortador de mangos 118
 Cortador de pasteles 190
 Cortador de patatas fritas 118
 Cortador de piña en rondajas 116
 Cortador de verduras 90, 115, 120-121
 Cortador de verduras Rouet 122
 Cortador en dados 115
 Cortador para croissants 193

Cortador para pan	246	Cuchillo tarta	313	Exprimidor cítricos	296
Cortador para pasteles	191	Cuchillo thai	123	Exprimidor cítricos, eléctrico	464, 466
Cortador para puros	353	Cuchillo verduras	86, 91		
Cortador tomates	115	Cuchillos profesionales y accesorios	137-162	FGH	
Cortador verduras, eléctrico	459, 463	Cuscusera	25	Fingerfood	323-324
Cortadora	157	Cuscusera	257	Flair bottle	298
Cortadora, eléctrico	472			Flexipan	231-243
Cortadores con eyector	174	D		Florero	350
Cortahuevos	117	Decantador	350	Fondo perforado	58-70
Cortapan	386	Decorador de limones	90, 94	Frasco dosificador	107-108
Cortapasta esterella	172	Decorador vegetales	122	Fregadoras	446-447
Cortapastas	265	Degustación/postre, set	329	Freidora	457-458
Cortapastas extensible	192	Delantal de protección	160	Fuente cocktail	401
Cortapastas, Inox	164-172	Delantal, LDPE	162	Fuente de mariscos	347, 401
Cortapastas, Pa+	173	Descorazonador	117, 90, 93	Fuente hierro fundido	258
Crepera	456-457	Deshidratador	459	Fuentes de horno de porcelana	48
Cubertería caviar	347	Dispensador	395	Fundidora de queso	345
Cubeta helado	278	Dispensador azúcar	271	Ganchos	154-155
Cubetas Gastronorm	50-79	Dispensador bar	298	GN-bandejas	56
Cubetas Gastronorm, Inox	52-60	Dispensador de bebidas isotérmico	399, 437	Gofrera	459
Cubetas Gastronorm, Melamina	76-77	Dispensador de cereales	383, 397-398	Grill de contacto	455-456
Cubetas Gastronorm, Policarbonato	61-65	Dispensador de leche	399	Guante de malla	160
Cubetas Gastronorm, Polipropilene	69-75	Dispensador zumos	383, 398-399	Guante de protección	161
Cubetas Gastronorm, Porcelana	78-81	Distribuidor de cucurucho	278	Guantes	161-162
Cubetas Gastronorm, Tritan	66-67	Dosificador	303-304	Guitarra	114
Cubitera	298, 384	Dosificador de crema	188	Heladería	277-281
Cubo	111	Dosificador de porciones	188	Herramientas para decorar chocolates	174
Cubo con prensa	449	Dosificador para azúcar	195	Hervidor de arroz	467
Cubo hielo	297, 437	Dosificador para miel/leche	271	Hervidor pescado	22, 28, 35
Cubo vino	348-350			Hidrómetro salmuera y sal	133
Cubrecajón, térmico	438	E		Hojas de acetato	197
Cubrecajones desechables	439	Embudo	106	Horno multifunción	457
Cubreplatos	106, 342	Embudo colador	188		
Cubrezapatos	162	Enfriador para yogurt	384	JL	
Cuchara	102	Ensacadora vertical	157	Jabón quita olores	94
Cuchara arroz	95, 255, 314	Equipo para cocinar al vacío	468	Jamonero	156
Cuchara cóctel	94, 289	Escalera para buffet	396	Jarra	325-326
Cuchara de ajeno	289	Escalera plegable	452	Jarra de medidas	106
Cuchara hielo	297, 315	Escamador	86, 91, 259	Jarra leche	271
Cuchara mágica	289	Escoba	446	Jarra para infusiones	325
Cuchara monobloc	100	Escurridor mural de platos	427	Jarra sake	253
Cuchara para ensaladas	95	Escurridor para fritura	22	Jarra soja	253-254
Cuchara refresco	289, 315	Espadas	154	Jarra térmica	325, 399-400
Cuchara salsa	315	Espátula crêpes	103	Juego pistola repostería	185
Cuchara servir	313	Espátula dulces	83, 98	Láminas del panadero	247
Cuchara sopa	252	Espátula fritura	82	Lámpara infrarrojos	461
Cuchara/Tenedor monoporción	315	Espátula hamburger	98	Lámpara para azúcar	189, 471
Cucharas medidoras	107	Espátula para alisar	190	Lazos de cocina	114
Cucharas para decoración	174	Espátula para diluir	81	Librador	108
Cucharita	253, 365-366	Espátula perforada	83, 97, 95, 101-102	Librador para hielo	297, 437
Cucharita para sal	314	Espátula pizza	98	Limpieza, artículos para	444-452
Cucharita parmesano	314	Espátulas	81-83, 92, 95, 98, 103, 105, 259	Linternas	377
Cucharón	81-83	Especiero cacao	271		
Cucharón de silicona	96	Espejos	376-377	M	
Cucharon perforado	82, 95, 102	Espumadera	82, 95, 102, 259	Maleta de barman	302
Cuchillo mantequilla	87, 92, 314	Espumadera monobloc	101	Maleta de Chef	151
Cuchillo ostras	86, 92	Estación de reciclaje, kit	450	Mandolina	120
Cuchillo para cítricos	89	Estantería bar para botellas	105, 302	Mangas para decorar	184-185
Cuchillo para decorar fruta	90	Esterilizador a inmersión	153	Manoplas de protección	160-161
Cuchillo para fondant/mazapán	174	Esterilizador para cuchillos, eléctrico	474	Mantelín para sushi	255
Cuchillo para pizza	86, 264	Etiquetas solubles	134	Mantelinas	344
Cuchillo para pomelo	89, 93	Expositor de buffet	372-373, 383, 394	Mantequera	124
Cuchillo para queso	87, 91	Expositor frutas	347, 400	Maquina helado	459
Cuchillo pasteles	87, 98	Exprime limones	296	Marcaador de tartas	193
Cuchillo roastbeef	314				

Marco para tarta	198-201	Pelador de manzanas, profesional	116	Posavasos	40, 346
Medidor de cóctel	290-291	Pelador de melon	89	Prensa para hamburguesa	157
Mesa cambia-pañales	444	Pelador de naranjas	89, 93	Prensador de ajo	92, 119
Microonda	468	Pelador de patatas	89, 93, 118	Prensador de patatas	91
Miniaturas	33, 36, 37	Pelador de piña	116	Prensador para canard	114
Molde cuchara	219	Pelador de tomates	89	Prensador para pulpo	114
Molde de cubitos de hielo	297	Pelador de verduras	118		
Molde nido	102	Pelador eléctrico	116	QR	
Molde para empanadillas	126	Pelador y cortador de aguacete	118	Quemador	188
Molde para huevos	219-200	Percolator de café	470	Quemador, eléctrico	472
Molde para nigiri	255	Peugeot	355-360	Quesera	341
Molde para pan	247	Picadura para embutido	153	Quita pepa/hueso	119-120
Moldes chocolate	213-221	Pico para hielo	296	Racionador	114
Moldes de Navidad	221	Piedra con soporte	345	Racionador de helado	93, 279
Moldes de Pascua	220-221	Piedra para afilar	146	Racionador de ensalada de frutas	89
Moldes Flexipan	231-243	Pincel cocina/pastelería	87, 92, 194	Rack de copas	302
Moldes magneticos	218	Pincel para wok	259	Rallador	88, 92, 119
Moldes, Aluminio	201	Pinchanotas	105	Rallador para wasabi	258
Moldes, Antiadherentes	203-208	Pinza	104, 105, 289	Ralladores	124-125
Moldes, Silicona	212, 222-229	Pinza azúcar	313	Rasqueta	194, 265
Molinillos pimienta/sal	339, 355-360	Pinza bogavante	346	Rastrillo	262
Molino	126-127	Pinza caracoles	313	Recipiente vertedor	299
Molino de hierbas finas	126	Pinza champaña	350	Recogemigas	342
Molino eléctrico	473	Pinza cierra bolsas	114	Red para pizza	266
Molino para tomates	126	Pinza espaguete	82, 95, 102, 312	Regla	190
Mortero y pistilo	258	Pinza espárragos	313	Rejilla	58, 187
Mostacero	335	Pinza frutas	312	Rejilla corta galletas	209-211
		Pinza fuente horns	264	Rejilla para tortas	187
		Pinza hielo	297, 313	Reloj de pared	134
NO		Pinza para barbacoa	104	Reloj digital	133
Nebulizador aceite/vinagre	340	Pinza para espinas	104	Repuestos	479-487
Núcleos de cocción	197	Pinza para jamón	155	Ribeteador de vasos	301
Olla chino	258	Pinza pasteles	312	Rodillo	192
Olla de barro	258	Pinza pato	258	Rodillo amasador	193-194
Olla de sopa	416	Pinza servir	82, 104, 312-314	Rodillos queso	184
Olla de sopa, eléctrico	470	Pistola	471	Rotulador de tiza líquida	392
Olla para cocinar al vapor	467	Pistola eléctrica	189	Roul'Pat	196
Omogenizador/emulsificador	464	Pizza, Accesorios	260-268	Ruleta cortapasta	86, 90, 192
		Placa caliente	461	Ruleta cortapizzas	86, 90, 264
P		Placa de inducción	404, 469	Runner	344
Pajitas	287	Placa de mesa	353	Rustidera	22, 27, 28, 35
Pala	447	Placa eutéctica	383, 435	Ruzador de mantequilla	89, 94
Pala chips	103	Placa pastelería	187, 268		
Pala para tartas	186, 313	Placa pizza	267-268	S	
Pala perforada	96	Plataforma móvil	441-442	Sable para champán	350
Pala pizza	261-262, 264	Platillo	252-253	Sacacorchos	305-306
Paleta de silicona	96	Plato	367, 371	Salero/pimentero	339
Paleta para tartas	95	Plato caracoles	347	Salinometro	133
Paleta recogedar cenizas	262	Plato hondo	317, 319, 321	Salsera	252, 336
Palillos	254, 259, 307	Plato llano	252, 317, 319, 321	Samovar	412
Palos	307	Plato para sushi	251	Sartén balti	257
Palos/Pinchos	154, 254, 307	Plato rectangular	317, 319	Sartén grill	40, 41
Pan, Accesorios	245-247	Ponchero	400	Sartén hierro	30
Paño para pasar caldo	113	Porcionador de café	93	Sartén para crêpes	346
Papel de horno	196, 197	Porta cucharas	272	Sartén para tortillas japonesas	257
Papelera	449	Porta cuchillos	153	Sartén tawa	257
Papelera sobremesa	346	Porta cuerda	156	Sartén toban	256
Parrilla de mesa	42	Porta etiquetas con clip	392	Sarténes acero	30
Parrilla reversible	41, 42, 44	Porta pajitas	272, 277	Secador mangas y boquillas	186
Pasapurés	118	Porta platos	427	Secador para moldes silicona	229
Pava	22	Porta tostadas	327	Señal de suelo	448
Pedestal giratorio para tartas	186	Portamenús	352	Separador de huevos	94
Pedestal para tartas	274-275, 400	Portarrollos	105, 439	Servicio de mesa	312-354
Pelador	89, 93, 115	Portatarjetas	352	Servicio para fondues	35, 345
Pelador de espárrago	89	Portavela	352		

Servilletero	272-273, 342	Termorregulador	406
Sierra de cocina	156	Tijeras de cocina	149-150
Sifón agua de seltz	296	Tijeras hierbas	118
Sifón montador de nata	280	Tijeras para ave	151
Sifón para Nitro	270	Tijeras para carne	258
Silform	244-245	Tijeras para pizza	264
Silla niños	444	Tijeras uva	312
Silpain	196	Timbre recepción	353
Silpat	196	Tocado, papel	162
Sopera cabeza de león	336	Tostador de pan	454
Soplador de azúcar	190	Transporte & Almacenamiento	424-442
Soplete cocina	189	Tritador de carne	472
Soporte	370-371, 373-375	Tritador de hielo	297, 465, 467
Soporte botellas	303		
Soporte dulces	273	U V W	
Soporte entremesas	365	Utensilios De Cocina	81-135
Soporte fuente mariscos	347	Utensilios De Pastelería	164-247
Soporte huevos	327	Vacia corazón piña	88, 116
Soporte móvil	431	Vaciador de zucchini	88, 93
Soporte número de mesa	352	Vaporera	255, 257
Soporte para bandejas	378	Varilla portaperiódico	378
Soporte para bols	394	Vaso	294-295
Soporte para botella	350	Vaso cocktail	295
Soporte para cubo	348	Vaso de calabaza	284
Soporte para cucuruchos	277	Vaso de piña	284
Soporte para film	105	Vasos	293-294
Soporte para mangas	186	Vasos con tapa	330-331
Soporte para pala pizzas	263	Vasos degustación	307-308
Soporte para palillos	254	Velas	378
Soporte para temaki	252	Vertedor	304, 350
Soporte platos pastre	362-363	Vitrina brioches	273
Soporte rotatorio	328	Vitrina caliente	458
Soporte vasos gourmet	331	Vitrina para buffet	381, 384, 392-393
Soporte/cesta	374	Vitrina para puros	353
Stencils	212	Wok	20, 30, 40, 256

T

Tabla	334
Tabla de corte	158-159, 391, 394
Tabla para sushi	251
Tablas para servir de madera	44-46
Tabletas chocolate	218
Tamiz para harina	195
Tapete de cocción silicona	196
Tapete para vasos	301
Tapón vertedor dosificador	304
Tapón champaña	305
Tapón para recipiente vertedor	301
Tapón vino	305
Taza julep	286
Taza moscow mule	284-286
Taza soba choko	251
Temperator	189, 471
Tenedor	95
Tenedor bogavante	346
Tenedor caracoles	315
Tenedor ostras	315
Tenedor para carne	96, 102, 138-146, 314
Tenedor para ensaladas	94
Tenedor servir	313
Tenedor, monobloc	100
Tenedores para fondue	345
Termómetro	130-133
Termometro para azúcar	190

NUMERICAL INDEX

INDICE NUMERICO

NUMERISCH INDEX

INDEX NUMERIQUE

INDICE NUMERICO

Cod.	pag.	Cod.	pag.	Cod.	pag.	Cod.	pag.
11001-16	13	11009-40	13	11061-50	14	11114-28	10
11001-18	13	11009-45	13	11061-50	17	11114-32	10
11001-20	13	11009-50	13	11101-16	9	11114-36	10
11001-22	13	11009-60	13	11101-20	9	11114-40	10
11001-24	13	11010-16	13	11101-24	9	11114-45	10
11001-28	13	11010-18	13	11101-28	9	11114-45	14
11001-32	13	11010-20	13	11101-32	9	11114-45	17
11001-36	13	11010-24	13	11101-36	9	11115-20	10
11001-40	13	11011-16	14	11101-40	9	11115-20	14
11001-45	13	11011-16	16	11101-45	9	11115-20	17
11001-50	13	11011-18	14	11101-50	9	11115-24	10
11001-60	13	11011-18	16	11102-28	9	11115-24	14
11006-12	14	11011-20	14	11102-32	9	11115-24	17
11006-12	17	11011-20	16	11102-36	9	11115-28	10
11006-14	14	11011-24	14	11102-40	9	11115-28	14
11006-14	17	11011-24	16	11102-45	9	11115-28	17
11006-16	14	11012-16	13	11102-50	9	11115-32	10
11006-16	17	11012-16	16	11105-16	9	11115-32	14
11006-18	14	11012-18	13	11105-20	9	11115-32	17
11006-18	17	11012-18	16	11105-24	9	11115-36	10
11006-20	14	11012-20	13	11105-28	9	11115-36	14
11006-20	17	11012-20	16	11105-32	9	11115-36	17
11006-22	14	11012-24	13	11105-36	9	11115-40	10
11006-22	17	11012-24	16	11105-40	9	11115-40	14
11006-24	14	11013-18	13	11106-14	9	11115-40	17
11006-24	17	11013-18	16	11106-16	9	11115-45	10
11006-28	14	11013-20	13	11106-20	9	11115-45	14
11006-28	17	11013-20	16	11106-24	9	11115-45	17
11006-32	14	11013-24	13	11106-28	9	11115-50	10
11006-32	17	11013-24	16	11106-32	9	11115-50	14
11006-36	14	11013-26	13	11106-36	9	11115-50	17
11006-36	17	11013-26	16	11107-16	9	11117-20	10
11007-16	13	11014-20	14	11107-20	9	11117-20	14
11007-18	13	11014-20	17	11107-24	9	11117-20	17
11007-20	13	11014-24	14	11107-28	9	11117-24	10
11007-22	13	11014-24	17	11107-32	9	11117-24	14
11007-24	13	11014-28	14	11107-36	9	11117-24	17
11007-28	13	11014-28	17	11107-40	9	11117-28	10
11007-32	13	11014-32	14	11107-45	9	11117-28	14
11007-36	13	11014-32	17	11107-50	9	11117-28	17
11007-40	13	11014-36	14	11108-16	10	11117-32	10
11007-45	13	11014-36	17	11108-20	10	11117-32	14
11007-50	13	11014-40	14	11108-24	10	11117-32	17
11007-60	13	11014-40	17	11108-28	10	11117-36	10
11008-16	14	11061-12	14	11108-32	10	11117-36	14
11008-16	17	11061-16	14	11108-36	10	11117-36	17
11008-18	14	11061-16	17	11109-16	9	11117-40	10
11008-18	17	11061-18	14	11109-20	9	11117-40	14
11008-20	14	11061-18	17	11109-24	9	11117-40	17
11008-20	17	11061-20	14	11109-28	9	11119-20	9
11008-24	14	11061-20	17	11109-32	9	11119-24	9
11008-24	17	11061-22	14	11109-36	9	11119-28	9
11008-28	14	11061-22	17	11109-40	9	11119-32	9
11008-28	17	11061-24	14	11109-45	9	1123-20	9
11008-32	14	11061-24	17	11109-50	9	1123-24	9
11008-32	17	11061-28	14	11112-16	10	1123-28	9
11008-36	14	11061-28	17	11112-18	10	1161-12	10
11008-36	17	11061-32	14	11112-20	10	1161-14	10
11009-16	13	11061-32	17	11112-24	10	1161-16	10
11009-18	13	11061-36	14	11113-18	10	1161-18	10
11009-20	13	11061-36	17	11113-20	10	1161-20	10
11009-24	13	11061-40	14	11113-24	10	1161-22	10
11009-28	13	11061-40	17	11113-26	10	1161-24	10
11009-32	13	11061-45	14	11114-20	10	1161-28	10
11009-36	13	11061-45	17	11114-24	10	1161-32	10

NUMERICAL INDEX INDICE NUMERICO NUMERISCH INDEX INDEX NUMERIQUE INDICE NUMERICO

Cod.	pag.	Cod.	pag.	Cod.	pag.	Cod.	pag.
11161-36	10	11718-22	30	11926-22	110	11955-45	109
11161-40	10	11718-24	30	11926-26	110	11955-50	109
11161-45	10	11721-28	30	11927-24	109	11956-37	400
11161-50	10	11739-20	267	11927-28	109	11956-42	400
11161-60	10	11739-24	267	11927-32	109	11957-20	109
11161-60	14	11739-28	267	11927-36	109	11957-25	109
11161-60	17	11739-32	267	11927-40	109	11957-30	109
11617-20	26	11740-14	267	11927-45	109	11957-35	109
11617-24	26	11740-16	267	11927-50	109	11957-40	109
11617-28	26	11740-18	267	11928-32	110	11963-99	22
11617-32	26	11740-20	267	11928-36	110	11965-50	22
11701-02	261	11740-22	267	11928-40	110	11965-60	22
11701-06	261	11740-24	267	11929-20	113	11965-61	22
11701-10	261	11740-26	267	11929-24	113	11967-06	100
11701-13	261	11740-28	267	11930-24	109	11967-08	100
11701-16	261	11740-30	267	11930-28	109	11967-09	100
11702-02	261	11740-32	267	11930-32	109	11967-10	100
11702-06	261	11740-36	267	11930-36	109	11967-12	100
11702-10	261	11740-40	267	11930-40	109	11967-14	100
11702-16	261	11741-20	267	11930-45	109	11967-16	100
11704-02	261	11741-24	267	11930-50	109	11967-18	100
11704-06	261	11741-26	267	11932-20	113	11967-20	100
11704-13	261	11741-28	267	11932-24	113	11967-24	100
11704-16	261	11741-32	267	11941-35	22	11968-18	100
11705-02	261	11742-16	267	11941-40	22	11968-20	100
11705-06	261	11742-18	267	11941-45	22	11968-24	100
11705-10	261	11742-20	267	11941-50	22	11969-02	101
11705-14	261	11742-22	267	11941-60	22	11969-06	100
11706-02	261	11742-24	267	11943-40	22	11969-37	100
11706-06	261	11742-26	267	11943-45	22	11970-01	101
11706-10	261	11742-28	267	11943-50	22	11970-06	100
11706-14	261	11742-30	268	11943-60	22	11970-08	100
11710-AA	30	11742-32	268	11943-61	22	11970-09	100
11710-AB	30	11742-36	268	11944-40	22	11970-10	100
11713-32	30	11742-40	268	11944-45	22	11970-11	100
11713-32	256	11742-45	268	11944-50	22	11970-12	100
11713-40	30	11742-50	268	11944-60	22	11970-14	100
11713-40	256	11742-60	268	11944-61	22	11970-16	100
11714-20	30	11744-20	267	11948-40	22	11971-01	102
11714-22	30	11744-24	267	11948-45	22	11971-08	101
11714-24	30	11744-28	267	11948-50	22	11971-10	101
11714-26	30	11744-32	267	11948-60	22	11971-12	101
11714-28	30	11750-11	58	11948-61	22	11971-14	101
11714-32	30	11760-11	58	11951-22	112	11971-16	101
11714-36	30	11910-12	23	11951-26	112	11971-18	101
11714-40	30	11910-14	23	11951-32	112	11971-20	101
11714-45	30	11910-16	23	11951-36	112	11971-25	101
11714-50	30	11910-18	23	11951-40	112	11972-10	101
11715-12	30	11910-20	23	11952-22	111	11972-12	101
11715-12	37	11911-12	23	11952-26	111	11973-01	101
11716-16	30	11911-14	23	11952-32	111	11973-10	101
11716-20	30	11911-16	23	11952-36	111	11973-12	101
11716-22	30	11911-18	23	11952-40	111	11974-50	100
11716-24	30	11911-20	23	11953-16	112	11974-70	100
11716-26	30	11913-16	23	11953-22	112	11975-01	101
11716-28	30	11913-20	23	11953-22	256	11975-50	101
11716-32	30	11913-24	23	11954-26	112	11975-99	101
11716-36	30	11913-28	23	11954-30	112	11976-50	101
11716-40	30	11922-36	23	11954-32	112	11976-99	101
11716-45	30	11922-40	23	11954-36	112	11982-01	101
11717-34	30	11924-18	110	11954-37	112	11982-38	100
11717-37	30	11924-20	110	11954-40	112	11983-37	100
11717-42	30	11924-22	110	11955-32	109	11983-38	100
11717-47	30	11924-24	110	11955-36	109	11984-38	100
11718-20	30	11924-28	110	11955-40	109	11985-34	101

Cod.	pag.	Cod.	pag.	Cod.	pag.	Cod.	pag.
11990-16	102	12119-20	16	12604-22	109	12909-23	190
11991-16	102	12119-24	16	12604-30	109	12915-25	81
12001-16	16	12119-28	16	12604-34	109	12915-26	81
12001-18	16	12119-32	16	12604-40	109	12915-35	81
12001-20	16	12504-20	105	12605-22	109	12915-45	81
12001-22	16	12507-24	20	12605-30	109	12916-25	81
12001-24	16	12507-28	20	12605-34	109	12916-33	81
12001-28	16	12508-24	20	12605-40	109	12917-25	81
12001-32	16	12509-12	20	12606-30	109	12920-01	82
12001-36	16	12509-12	37	12606-34	109	12920-05	82
12001-40	16	12509-20	20	12607-22	109	12920-10	82
12001-45	16	12509-24	20	12607-30	109	12920-11	82
12001-50	16	12509-28	20	12607-34	109	12920-15	82
12001-60	16	12511-10	20	12622-07	112	12920-16	82
12007-16	16	12511-10	37	12622-10	112	12921-01	81
12007-18	16	12511-12	20	12622-12	112	12921-05	81
12007-20	16	12511-12	37	12622-14	112	12921-10	81
12007-22	16	12511-14	20	12622-16	112	12921-15	82
12007-24	16	12511-14	37	12622-18	112	12926-35	84
12007-28	16	12511-16	20	12622-20	112	12927-35	84
12007-32	16	12511-18	20	12622-23	112	12927-45	84
12007-36	16	12511-20	20	12622-26	112	12928-25	84
12007-40	16	12511-24	20	12630-22	112	12928-30	84
12007-45	16	12513-16	20	12633-16	112	12928-35	84
12007-50	16	12513-18	20	12633-18	112	12928-40	84
12007-60	16	12513-20	20	12633-20	112	12928-45	84
12009-16	16	12513-24	20	12633-23	112	12928-50	84
12009-18	16	12514-20	20	12633-26	112	12928-55	84
12009-20	16	12514-24	20	12635-23	113	12928-60	84
12009-24	16	12514-26	20	12635-26	113	12929-25	84
12009-28	16	12514-28	20	12635-30	113	12929-30	84
12009-32	16	12514-32	20	12635-35	113	12929-35	84
12009-36	16	12514-36	20	12636-32	113	12929-40	84
12009-40	16	12517-24	20	12638-20	113	12929-45	84
12009-45	16	12517-26	20	12640-14	103	12930-51	82
12009-50	16	12517-28	20	12640-16	103	12930-52	82
12009-60	16	12517-32	20	12640-18	103	12930-62	82
12037-16	16	12517-36	20	12640-20	103	12930-63	82
12101-16	11	12529-32	20	12640-24	103	12930-68	82
12101-20	11	12529-32	256	12640-28	103	12930-69	82
12101-24	11	12561-16	20	12641-14	103	12930-74	82
12101-28	11	12561-18	20	12641-16	103	12930-77	82
12101-32	11	12561-20	20	12641-18	103	12930-78	82
12101-36	11	12561-24	20	12641-20	103	12931-51	83
12101-40	11	12561-26	20	12641-24	103	12931-53	83
12101-45	11	12561-28	20	12641-28	103	12932-22	84
12101-50	11	12580-11	110	12642-28	103	12932-26	84
12107-16	11	12580-17	110	12903-30	81	12940-02	108
12107-20	11	12580-21	110	12903-40	81	12940-05	108
12107-24	11	12580-24	110	12903-45	81	12940-10	108
12107-28	11	12580-29	110	12905-25	81	12940-20	108
12107-32	11	12580-30	110	12905-30	81	12940-25	108
12107-36	11	12580-31	110	12905-35	81	12941-07	84
12107-40	11	12580-36	110	12905-40	81	12941-10	84
12107-45	11	12580-40	110	12905-45	81	12941-12	84
12107-50	11	12580-45	110	12905-50	81	12941-14	84
12109-16	11	12580-50	110	12906-35	81	12941-16	84
12109-20	11	12582-13	110	12907-07	81	12941-18	84
12109-24	11	12582-17	110	12907-08	81	12941-20	84
12109-28	11	12582-22	110	12908-30	81	12941-23	84
12109-32	11	12582-24	110	12908-35	81	12941-26	84
12109-36	11	12582-32	110	12908-40	81	12943-03	114
12109-40	11	12582-34	110	12909-12	81	12943-03	173
12109-45	11	12582-38	110	12909-12	190	12943-05	114
12109-50	11	12582-40	110	12909-23	81	12943-05	173

NUMERICAL INDEX INDICE NUMERICO NUMERISCH INDEX INDEX NUMERIQUE INDICE NUMERICO

Cod.	pag.	Cod.	pag.	Cod.	pag.	Cod.	pag.
12943-07	114	14004-00	425	14142-10	52	14255-15	54
12943-07	173	14006-00	425	14142-15	52	14255-20	54
12943-08	114	14007-00	425	14142-20	52	14301-02	56
12943-08	173	14008-00	425	14145-10	52	14301-04	56
12943-10	114	14010-00	425	14145-15	52	14301-06	56
12943-10	173	14011-00	425	14145-20	52	14302-02	56
12943-12	114	14013-00	425	14147-10	52	14302-04	56
12943-12	173	14015-08	425	14147-15	52	14302-06	56
12943-13	173	14101-02	50	14147-20	52	14303-02	56
12944-03	114	14101-04	50	14148-10	52	14303-04	56
12944-03	173	14101-06	50	14148-15	52	14303-06	56
12944-05	114	14101-10	50	14148-20	52	14305-02	56
12944-05	173	14101-15	50	14151-10	53	14305-04	56
12944-07	114	14101-20	50	14151-15	53	14305-06	56
12944-07	173	14102-02	50	14151-20	53	14362-02	56
12944-08	114	14102-04	50	14152-06	53	14362-04	56
12944-08	173	14102-04	415	14152-10	53	14362-06	56
12944-10	114	14102-06	50	14152-15	53	14365-02	56
12944-10	173	14102-06	415	14152-20	53	14365-04	56
12944-12	114	14102-10	50	14155-10	53	14365-06	56
12944-12	173	14102-15	50	14155-15	53	14402-00	58
12944-13	173	14102-20	50	14155-20	53	14405-00	58
12947-02	173	14103-02	51	14157-10	53	14407-00	58
12947-03	173	14103-04	51	14157-15	53	14409-01	58
12947-04	173	14103-06	51	14157-20	53	14409-02	58
12947-05	173	14103-10	51	14158-10	53	14480-20	302
12947-06	173	14103-15	51	14158-15	53	14502-00	55
12947-07	173	14103-20	51	14158-20	53	14503-00	55
12947-13	173	14104-06	51	14159-10	53	14504-00	55
12950-32	84	14104-10	51	14159-15	53	14505-00	55
12950-32	110	14104-15	51	14159-20	53	14507-00	55
12950-40	84	14105-02	51	14162-02	53	14508-00	55
12950-40	110	14105-04	51	14162-04	53	14509-00	55
12967-06	83	14105-06	51	14162-06	53	14510-00	55
12967-10	83	14105-10	51	14165-02	53	14512-00	55
12968-10	83	14105-15	51	14165-04	53	14515-00	55
12968-10	266	14105-20	51	14165-06	53	14517-00	55
12969-06	83	14107-06	51	14201-02	54	14518-00	55
12969-10	83	14107-10	51	14201-04	54	14519-00	55
12970-06	83	14107-15	51	14201-06	54	14522-00	55
12970-08	83	14107-20	51	14201-10	54	14523-00	55
12970-10	83	14108-06	51	14201-15	54	14525-00	55
12970-12	83	14108-10	51	14201-20	54	14527-00	55
12971-10	83	14108-15	51	14202-02	54	14528-00	55
12971-12	83	14108-20	51	14202-04	54	14529-00	55
12972-10	83	14109-06	51	14202-06	54	14532-00	55
12972-12	83	14109-10	51	14202-10	54	14535-00	55
12973-10	83	14109-15	51	14202-15	54	14537-00	55
12973-12	83	14109-20	51	14202-20	54	14538-00	55
12986-01	83	14110-06	51	14203-06	54	14539-00	55
12986-38	83	14110-10	51	14203-10	54	14542-00	55
12992-36	23	14112-10	51	14203-15	54	14543-00	55
12992-36	28	14112-15	51	14203-20	54	14545-00	55
12992-40	23	14112-20	51	14205-02	54	14547-00	55
12992-40	28	14115-10	52	14205-04	54	14548-00	55
14001-09	424	14115-15	52	14205-06	54	14549-00	55
14001-16	424	14115-20	52	14205-10	54	14552-00	56
14001-25	424	14117-10	52	14205-15	54	14555-00	56
14001-36	424	14117-15	52	14205-20	54	14561-15	59
14001-49	424	14117-20	52	14252-06	54	14561-20	59
14003-09	424	14118-10	52	14252-10	54	14562-06	59
14003-16	424	14118-15	52	14252-15	54	14562-10	59
14003-25	424	14118-20	52	14252-20	54	14562-15	59
14003-36	424	14119-10	52	14255-06	54	14562-20	59
14003-49	425	14119-15	52	14255-10	54	14565-06	59

<u>Cod.</u>	<u>pag.</u>	<u>Cod.</u>	<u>pag.</u>	<u>Cod.</u>	<u>pag.</u>	<u>Cod.</u>	<u>pag.</u>
14565-10	59	14689-00	65	14802-15	62	14912-00	70
14565-15	59	14690-00	65	14802-20	62	14915-00	70
14565-20	59	14691-00	65	14805-06	62	14922-00	71
14567-06	60	14692-00	65	14805-10	62	14922-11	71
14567-10	60	14695-00	65	14805-15	62	14922-22	71
14567-15	60	14702-06	67	14805-20	62	14922-33	71
14567-20	60	14702-10	67	14807-06	62	14922-99	71
14568-06	60	14702-15	67	14807-10	62	14925-00	71
14568-10	60	14702-20	67	14807-15	62	14925-11	71
14568-15	60	14705-06	67	14807-20	62	14925-22	71
14568-20	60	14705-10	67	14808-06	62	14925-33	71
14569-06	60	14705-15	67	14808-10	62	14925-99	71
14569-10	60	14705-20	67	14808-15	62	14927-00	71
14569-15	60	14707-06	67	14808-20	62	14927-11	71
14569-20	60	14707-10	67	14809-06	62	14927-22	71
14570-06	60	14707-15	67	14809-10	62	14927-33	71
14570-10	60	14707-20	67	14809-15	62	14927-99	71
14571-00	60	14708-06	67	14809-20	62	14928-00	71
14572-00	60	14708-10	67	14810-06	62	14928-11	71
14575-00	60	14708-15	67	14810-10	62	14928-22	71
14577-00	60	14708-20	67	14811-00	63	14928-33	71
14578-00	60	14709-06	67	14812-00	63	14928-99	71
14579-00	60	14709-10	67	14815-00	63	14929-00	71
14580-00	60	14709-15	67	14817-00	63	14929-11	71
14585-00	60	14709-20	67	14818-00	63	14929-22	71
14591-00	60	14710-06	67	14819-00	63	14929-33	71
14592-00	60	14710-10	67	14820-00	63	14929-99	71
14595-00	60	14712-00	67	14821-00	63	14930-00	71
14597-00	60	14715-00	67	14822-00	63	14930-11	71
14598-00	60	14717-00	67	14825-00	63	14930-22	71
14599-00	60	14718-00	67	14827-00	63	14930-33	71
14661-20	64	14719-00	67	14828-00	63	14930-99	71
14662-06	64	14722-00	68	14829-00	63	14958-01	297
14662-10	64	14722-11	68	14830-00	63	14958-02	297
14662-15	64	14722-22	68	14832-00	63	15100-01	73
14662-20	64	14722-33	68	14835-00	63	15100-02	73
14665-06	64	14722-99	68	14837-00	63	15100-03	73
14665-10	64	14725-00	68	14838-00	63	15100-04	73
14665-15	64	14725-11	68	14839-00	63	15100-AA	73
14665-20	64	14725-22	68	14840-00	63	15101-06	73
14667-06	65	14725-33	68	14851-00	63	15101-10	73
14667-10	65	14725-99	68	14852-00	63	15101-15	73
14667-15	65	14727-00	68	14855-00	63	15101-20	73
14667-20	65	14727-11	68	14902-06	70	15105-06	73
14668-06	65	14727-22	68	14902-10	70	15105-10	73
14668-10	65	14727-33	68	14902-15	70	15105-15	73
14668-15	65	14727-99	68	14902-20	70	15105-20	73
14668-20	65	14728-00	68	14905-06	70	15107-06	73
14669-06	65	14728-11	68	14905-10	70	15107-10	73
14669-10	65	14728-22	68	14905-15	70	15107-15	73
14669-15	65	14728-33	68	14905-20	70	15107-20	73
14669-20	65	14728-99	68	14907-06	70	15108-06	73
14670-06	65	14729-00	68	14907-10	70	15108-10	73
14670-10	65	14729-11	68	14907-15	70	15108-15	73
14671-00	65	14729-22	68	14907-20	70	15108-20	73
14672-00	65	14729-33	68	14908-06	70	15109-06	73
14675-00	65	14729-99	68	14908-10	70	15109-10	73
14677-00	65	14730-00	68	14908-15	70	15109-15	73
14678-00	65	14730-11	68	14908-20	70	15109-20	73
14679-00	65	14730-22	68	14909-06	70	15110-06	73
14680-00	65	14730-33	68	14909-10	70	15110-10	73
14682-00	65	14730-99	68	14909-15	70	15224-10	33
14685-00	65	14801-20	62	14909-20	70	15224-12	33
14687-00	65	14802-06	62	14910-06	70	15224-14	33
14688-00	65	14802-10	62	14910-10	70	15225-10	33

NUMERICAL INDEX INDICE NUMERICO NUMERISCH INDEX INDEX NUMERIQUE INDICE NUMERICO

<u>Cod.</u>	<u>pag.</u>	<u>Cod.</u>	<u>pag.</u>	<u>Cod.</u>	<u>pag.</u>	<u>Cod.</u>	<u>pag.</u>
15225-12	33	16101-50	25	16127-40	26	16940-36	201
15225-14	33	16106-16	25	16134-12	36	16940-40	201
15226-07	33	16106-20	25	16135-12	36	16941-40	27
15226-10	33	16106-24	25	16136-10	36	16941-45	27
15226-12	33	16106-28	25	16137-10	36	16941-50	27
15226-14	33	16107-16	25	16138-10	36	16941-60	27
15227-10	33	16107-20	25	16139-10	36	16941-61	27
15227-12	33	16107-24	25	16302-02	57	16943-40	27
15227-14	33	16107-28	25	16302-04	57	16943-45	27
15228-10	33	16107-32	25	16302-06	57	16943-50	27
15229-10	33	16107-36	25	16303-02	57	16943-60	27
15261-10	33	16107-40	25	16303-04	57	16943-61	27
15261-12	33	16107-45	25	16303-06	57	16944-45	28
15261-14	33	16107-50	25	16305-02	57	16944-50	28
15338-38	35	16108-20	25	16305-04	57	16944-60	28
15339-36	35	16108-24	25	16305-06	57	16947-40	27
15343-36	35	16108-28	25	16362-02	57	16947-45	27
15401-51	35	16109-24	25	16362-04	57	16947-50	27
15403-16	35	16109-28	25	16362-06	57	16947-60	27
15406-16	35	16109-32	25	16363-02	57	16947-61	27
15406-20	35	16109-36	25	16363-04	57	16948-40	27
15407-16	35	16109-40	25	16363-06	57	16948-45	27
15407-20	35	16109-45	25	16365-02	57	16948-50	27
15409-26	35	16109-50	25	16365-04	57	16948-60	27
15409-30	35	16109-60	25	16365-06	57	16948-61	27
15409-36	35	16113-20	27	16712-22	27	16961-16	26
15412-25	35	16113-24	27	16712-26	27	16961-20	26
15415-03	35	16113-28	27	16712-30	27	16961-24	26
15428-06	345	16113-32	27	16717-20	27	16961-28	26
15430-11	35	16113-36	27	16717-24	27	16961-32	26
15430-11	345	16113-40	27	16717-28	27	16961-36	26
15438-50	35	16114-20	26	16717-32	27	16961-40	26
15506-16	32	16114-24	26	16717-36	27	16961-45	26
15506-20	32	16114-28	26	16717-40	27	16961-50	26
15506-24	32	16114-32	26	16719-12	27	16961-60	26
15506-28	32	16114-36	26	16719-12	37	16965-40	28
15507-16	32	16114-40	26	16910-14	28	16965-50	28
15507-20	32	16115-24	26	16910-16	28	16965-60	28
15507-24	32	16115-28	26	16910-18	28	17101P12	338
15507-28	32	16115-32	26	16910-20	28	17101P16	338
15508-20	32	16115-36	26	16923-32	25	17101P20	338
15508-24	32	16115-40	26	16923-36	25	17101S12	339
15508-28	32	16115-45	26	16923-40	25	17101S16	339
15509-20	32	16116-28	26	16924-20	110	17101S20	339
15509-24	32	16116-32	26	16924-24	110	17105P13	339
15509-28	32	16116-36	26	16924-28	110	17105S13	339
15514-20	32	16116-40	26	16926-32	25	17106P13	339
15514-24	32	16117-20	26	16926-36	25	17106S13	339
15514-28	32	16117-24	26	16926-40	25	17111P12	339
15514-32	32	16117-28	26	16927-32	110	17111P16	339
15515-20	32	16117-32	26	16927-36	110	17111P20	339
15515-24	32	16117-36	26	16927-40	110	17111S12	339
15515-28	32	16117-40	26	16927-45	110	17111S16	339
15515-32	32	16118-24	27	16927-50	110	17111S20	339
15561-20	32	16120-24	26	16929-36	28	17610-01	108
15561-24	32	16120-28	26	16929-40	28	17610-02	108
15561-28	32	16120-32	26	16938-36	25	17610-05	108
16101-16	25	16120-36	26	16938-40	25	17610-10	108
16101-20	25	16120-40	26	16938-45	25	18000-16	140
16101-24	25	16127-16	26	16939-50	28	18000-20	140
16101-28	25	16127-20	26	16939-60	28	18000-23	140
16101-32	25	16127-24	26	16939-70	28	18000-26	140
16101-36	25	16127-28	26	16939-80	28	18000-26	151
16101-40	25	16127-32	26	16940-28	201	18000-30	140
16101-45	25	16127-36	26	16940-32	201	18000-30	151

Cod.	pag.	Cod.	pag.	Cod.	pag.	Cod.	pag.
18000-36	140	18029-36	142	18199-19	151	18282-19	148
18002-18	140	18030-26	142	18201-36	145	18282-22	148
18002-18	151	18030-31	142	18203-26	145	18283-27	148
18002-20	140	18030-36	142	18205-10	144	18283-33	148
18002-22	140	18099-15	151	18205-12	144	18284-21	148
18002-26	140	18100-16	137	18206-09	144	18284-27	148
18002-26	151	18100-20	137	18207-15	144	18284-30	148
18002-30	140	18100-20	152	18209-06	144	18284-33	148
18002-36	140	18100-24	137	18215-13	145	18301-01	264
18005-22	140	18100-24	151	18215-21	145	18301-02	264
18005-27	140	18100-24	152	18217-12	142	18302-01	264
18005-32	140	18100-30	137	18218-12	146	18302-02	265
18006-20	140	18100-30	151	18220-18	144	18323-00	264
18006-25	140	18100-36	137	18220-20	144	18324-00	264
18006-30	140	18102-16	137	18220-22	144	18324-10	86
18006-36	140	18102-16	152	18220-26	144	18324-10	264
18007-25	140	18102-20	137	18221-17	144	18325-01	192
18007-30	140	18102-26	137	18221-19	144	18325-02	192
18007-36	140	18102-30	137	18221-21	144	18325-03	192
18008-20	140	18103-18	137	18222-18	145	18501-01	265
18008-26	140	18104-18	137	18224-28	144	18501-02	265
18008-30	140	18106-15	137	18225-28	144	18501-03	265
18008-36	140	18106-20	137	18226-17	146	18501-04	265
18009-25	140	18106-20	152	18230-13	138	18501-05	265
18009-30	140	18106-25	137	18230-17	138	18502-18	265
18009-30	151	18106-25	152	18230-17	151	18503-12	265
18009-36	140	18106-30	137	18230-17	151	18504-15	265
18010-25	141	18109-26	137	18230-17	152	18509-01	97
18010-30	141	18109-26	152	18230-17	152	18509-02	97
18010-36	141	18109-30	137	18231-13	138	18509-03	97
18011-32	140	18109-36	137	18235-26	146	18510-07	97
18012-32	141	18110-26	137	18235-26	152	18511-15	98
18013-30	141	18110-30	137	18235-26	152	18512-15	98
18013-36	141	18110-36	137	18235-30	146	18513-14	98
18015-18	141	18111-30	137	18235-30	151	18514-17	98
18015-22	141	18112-30	137	18235-30	151	18514-18	98
18015-27	141	18112-30	151	18236-30	146	18514-18	145
18016-14	141	18114-20	137	18237-26	146	18515-16	98
18016-16	141	18115-20	138	18251-01	146	18516-24	98
18016-16	151	18115-20	151	18251-02	146	18517-24	98
18017-14	141	18115-25	138	18255-00	151	18518-22	98
18017-16	141	18116-14	138	18255-00	153	18518-26	98
18017-18	141	18116-14	151	18261-00	150	18518-30	98
18018-11	141	18116-14	152	18263-00	151	18519-15	98
18019-12	141	18116-18	138	18270-22	150	18519-22	98
18019-14	141	18122-12	138	18271-00	150	18519-26	98
18019-16	141	18123-11	138	18271-00	152	18519-26	151
18019-18	141	18124-09	138	18271-00	152	18519-30	98
18019-20	141	18124-09	152	18272-00	149	18519-35	98
18020-23	141	18124-09	152	18273-00	150	18520-04	98
18021-18	141	18125-07	138	18274-00	150	18520-06	98
18022-12	142	18125-10	138	18275-00	151	18520-08	98
18023-11	142	18125-10	151	18276-00	150	18520-10	98
18024-08	142	18126-07	138	18276-00	151	18520-12	98
18024-11	142	18126-07	151	18276-00	151	18520-15	266
18024-11	151	18126-07	152	18276-00	264	19701-00	130
18026-07	142	18128-20	138	18277-00	118	19702-00	130
18026-07	151	18128-20	152	18277-00	150	19705-00	130
18028-21	142	18128-24	138	18278-00	149	19706-00	130
18028-25	142	18128-24	152	18279-14	150	19709-00	130
18028-30	142	18128-30	138	18280-10	148	19810-00	128
18028-30	151	18128-30	151	18280-16	148	19901-35	379
18028-36	142	18190-09	152	18280-22	148	19901-40	379
18029-25	142	18191-22	152	18281-24	148	19901-47	379
18029-30	142	18192-09	152	18282-18	148	19902-38	378

NUMERICAL INDEX INDICE NUMERICO NUMERISCH INDEX INDEX NUMERIQUE INDICE NUMERICO

Cod.	pag.	Cod.	pag.	Cod.	pag.	Cod.	pag.
31509-01	350	41205-07	329	41394-02	392	41455T55	280
32931-02	351	41205-08	310	41400-AA	382	41456-02	296
32931-03	351	41205-08	329	41403-01	396	41457-00	297
32931-05	351	41205-09	310	41403-02	396	41458-02	280
32935-03	351	41205-09	329	41403-03	396	41458-05	280
32935-05	351	41205-10	310	41403-04	397	41458-10	280
32935-10	351	41205-10	329	41405-AA	382	41458-11	281
32935-22	351	41210-01	37	41412-11	384	41458-21	281
32936-03	351	41210-03	37	41414-30	274	41458-23	280
32936-05	351	41210-05	37	41414-31	275	41458-24	281
41200-01	323	41210-07	37	41415-10	393	41458-25	281
41200-02	323	41210-08	37	41415-11	389	41458-50	281
41200-03	323	41210-10	37	41415-11	393	41458-51	281
41200-04	323	41210-12	37	41418-11	390	41459-10	280
41200-05	323	41210-13	37	41418-12	390	41460-05	280
41200-06	323	41210-14	37	41419-12	390	41460-10	280
41200-07	323	41311-00	345	41425-AA	382	41461-07	292
41200-08	323	41312-00	345	41427-40	394	41461B07	292
41200-09	323	41315-02	345	41428-03	393	41461C07	292
41200-10	323	41315-04	345	41429-04	392	41461G07	292
41200-11	323	41317-20	345	41430-11	379	41463-01	284
41200-13	323	41320-25	335	41436-11	379	41463-02	285
41200-14	323	41320-30	335	41436-12	379	41463A00	286
41200-15	323	41320-35	335	41437-11	379	41463A05	285
41200-16	323	41321-40	335	41437-12	379	41463A30	285
41200-17	323	41321-44	335	41438-50	379	41463A50	285
41200-18	324	41322-19	335	41438-60	379	41463B05	285
41200-32	324	41322-25	335	41438-70	379	41463C00	286
41200-33	324	41322-31	335	41439-32	379	41463C30	285
41200-34	324	41323-01	332	41439-38	379	41463C50	285
41200-36	324	41323-02	332	41439-48	379	41463G05	285
41200-40	324	41323-03	332	41442-01	394	41464-09	292
41200-41	324	41323-04	332	41442-03	394	41464B09	292
41200-46	324	41323-06	332	41442-14	394	41464C09	292
41200-47	324	41323-07	332	41442-23	394	41464G09	292
41200-48	324	41323-08	332	41445-01	375	41465-10	296
41200-49	324	41323-11	332	41445-02	375	41467B08	292
41200-50	324	41323-12	332	41445-22	375	41467C08	292
41200-51	324	41323-13	332	41445-26	375	41467G08	292
41200-52	324	41323-14	332	41445-30	375	41468-20	279
41200-53	324	41323-16	332	41446-18	375	41468-24	279
41200-54	324	41323-17	332	41446-23	375	41469-20	279
41200-55	324	41323-18	332	41447-02	392	41469-24	279
41200-56	324	41323-21	332	41447-05	392	41470A00	286
41200-57	324	41323-22	332	41447-38	274	41470A03	286
41200-58	324	41323-23	332	41447-38	392	41470C00	286
41200-59	324	41323-24	332	41448-06	394	41470C03	286
41200-60	324	41323-26	332	41448-10	394	41471-00	278
41200-61	324	41323-27	332	41448-25	394	41471-12	278
41200-62	324	41323-28	332	41448-40	394	41471-15	278
41200-63	324	41323-99	333	41449-27	400	41471-17	278
41200-64	324	41325-20	335	41449-32	400	41472-01	277
41205-01	309	41325-30	335	41450-AA	280	41472-04	277
41205-01	329	41325-40	335	41451-05	280	41472-15	278
41205-02	310	41326-30	335	41451-10	280	41472-16	278
41205-02	329	41326-36	335	41452N10	270	41472-20	277
41205-03	310	41326-42	335	41452N16	270	41472-21	277
41205-03	329	41327-01	334	41453-11	296	41472-22	277
41205-04	310	41327-02	334	41453-AA	296	41472-32	273
41205-04	329	41327-03	334	41454-01	296	41473-31	279
41205-05	310	41327-04	334	41454-99	296	41473-39	279
41205-05	329	41327-05	334	41455-AB	281	41473-44	279
41205-06	310	41380-01	134	41455-BC	280	41473-50	279
41205-06	329	41380-02	134	41455-CA	281	41473-56	279
41205-07	310	41390-00	353	41455-CB	281	41473-62	279

Cod.	pag.	Cod.	pag.	Cod.	pag.	Cod.	pag.
41473-66	279	41491G03	288	41518C12	297	41570G10	290
41474-00	279	41491G04	288	41518G12	297	41582-00	156
41474-02	280	41491G05	288	41520-08	108	41583-00	157
41475-00	279	41491G06	289	41520-12	108	41585-00	328
41475-01	279	41492-00	307	41520-16	108	41585-01	328
41475-03	279	41492B00	307	41520-24	108	41585-02	328
41475-04	279	41492C00	307	41521-10	309	41585-03	328
41475-05	279	41492G00	307	41522-14	309	41585-10	328
41476-50	279	41493B00	284	41523-08	308	41585-11	327
41477-50	293	41493C00	284	41523-09	308	41585-12	327
41478-35	293	41493G00	284	41523G08	309	41585-13	327
41478-50	293	41494B00	284	41523G09	309	41585-23	327
41479-05	292	41494C00	284	41524-04	308	41585-24	327
41479-05	302	41494G00	284	41524-09	308	41585-25	327
41479-11	292	41495-08	288	41524-10	309	41585-30	327
41479-12	292	41495-10	288	41524-11	309	41585-37	327
41479-13	292	41496-40	350	41524-12	309	41585-45	328
41479-14	292	41497-05	286	41524C10	309	41585-51	328
41479-15	292	41497B05	286	41524C11	309	41585-52	328
41479-AA	293	41497C05	286	41524C12	309	41585-53	328
41480-03	291	41497G05	286	41525-00	271	41585-54	328
41480-05	291	41498B00	284	41525-01	271	41586-22	328
41480-05	302	41498C00	284	41526-01	107	41586-28	328
41480-07	291	41498G00	284	41526-02	108	41586-33	328
41480B05	292	41499-00	307	41526-05	108	41586-38	328
41480C05	292	41499-08	350	41526-06	108	41587-25	328
41480G05	292	41501-20	348	41526-B1	107	41587-32	328
41481-02	291	41502-20	348	41526-B2	107	41589-08	330
41481-03	291	41503-00	297	41526-B3	107	41589-14	330
41483-04	291	41503-21	297	41526-G1	107	41589-16	330
41483-06	291	41503-22	297	41526-G2	107	41589-20	331
41484-05	291	41503-22	302	41526-G3	107	41589-22	330
41484B05	291	41504-09	349	41526-R1	107	41589-25	331
41484C05	291	41504-10	349	41526-R2	107	41589-37	331
41484G05	291	41504-11	349	41526-R3	107	41589-50	331
41486-08	278	41504-12	349	41527-10	308	41589-58	331
41486-12	278	41504-19	349	41527-11	308	41589-99	331
41486-15	278	41505-17	349	41527-12	308	41589-AA	331
41487-12	279	41505-19	349	41527-13	308	41589-AB	331
41487-15	279	41505-20	348	41527G10	309	41589-AC	331
41487-17	279	41507-01	349	41527G11	309	41589-AC	331
41488-45	279	41508-10	349	41527G12	309	41589-BB	331
41488-47	279	41508C12	349	41527G13	309	41589C08	331
41488-50	279	41510-05	298	41528-21	107	41589C16	331
41488-53	279	41510-08	350	41528-22	107	41589-CC	331
41489-20	279	41511-00	350	41529-05	326	41591-32	348
41490-00	287	41511-20	350	41530-05	326	41591-36	348
41490-01	287	41511-25	350	41530-07	326	41591-40	348
41490-AA	287	41511-30	350	41530-11	326	41591-45	348
41490B00	287	41512-15	298	41537-33	274	41591-90	347
41490B01	287	41512-30	298	41537-34	274	41592-36	348
41490C00	287	41512-50	298	41538-30	274	41592-45	348
41490C01	287	41513-13	297	41541-44	400	41593-20	347
41490G00	287	41513B20	298	41558-00	348	41594-12	347
41490G01	287	41513C20	298	41559-04	348	41594-18	347
41491C00	288	41513G20	298	41560-28	342	41595-20	289
41491C01	288	41514-05	293	41561-09	335	41595-20	302
41491C02	288	41514-10	293	41562-18	347	41597-04	327
41491C03	288	41515-03	297	41563-07	335	41598-00	327
41491C04	288	41515-05	297	41564-07	335	41599-08	327
41491C05	288	41515-07	297	41569-33	345	41600-00	289
41491C06	289	41518-00	347	41570-10	112	41600C00	289
41491G00	288	41518-01	347	41570-10	290	41600G00	289
41491G01	288	41518-02	347	41570B10	290	41601-17	272
41491G02	288	41518B12	297	41570C10	290	41602-00	272

NUMERICAL INDEX INDICE NUMERICO NUMERISCH INDEX INDEX NUMERIQUE INDICE NUMERICO

<u>Cod.</u>	<u>pag.</u>	<u>Cod.</u>	<u>pag.</u>	<u>Cod.</u>	<u>pag.</u>	<u>Cod.</u>	<u>pag.</u>
41603-00	290	41636-25	340	41681-99	299	41720-28	26
41603-00	302	41638-01	341	41683-26	106	41720-30	26
41603-07	290	41638-02	341	41686-12	347	41720-32	26
41603B00	290	41638-04	340	41687-06	347	41727-28	266
41603B07	290	41638-12	341	41687-12	347	41727-30	266
41603C00	290	41638-13	341	41693A54	413	41727-33	266
41603C07	290	41639-11	342	41693E54	413	41727-36	266
41603G00	290	41639-17	342	41693U54	413	41727-40	266
41603G07	290	41639-30	342	41694A02	414	41727-45	266
41604-00	290	41639-31	342	41694A54	414	41727-50	266
41604-00	302	41639-32	342	41694A60	414	41727-55	266
41604-01	291	41639-40	342	41694E54	414	41727-60	266
41604B00	290	41639-41	342	41694U54	414	41729-30	203
41604B01	291	41639-42	342	41695-10	416	41729-30	267
41604C00	290	41640-03	325	41695-15	416	41729-34	203
41604C01	291	41640-06	325	41695-50	416	41729-34	267
41604G00	290	41640-08	325	41695-90	416	41734-60	266
41604G01	291	41645-00	271	41697-00	104	41735-20	262
41605-00	289	41646-06	325	41698-22	104	41735-29	261
41605-00	302	41646-10	325	41698-30	104	41736-32	262
41605-01	289	41646-15	325	41698-40	104	41737-17	262
41605-03	289	41646-20	325	41699-03	306	41737-20	262
41605-25	289	41650-06	325	41699-04	306	41737-23	262
41605-25	315	41650-10	325	41699-06	302	41737G20	264
41605B03	289	41650-13	325	41699-06	306	41737G23	264
41605B27	289	41651-20	380	41699-10	305	41738-17	262
41605C03	289	41651-25	380	41699-11	305	41738-20	262
41605G03	289	41651-30	380	41699-12	306	41738-23	262
41605G27	289	41651-35	380	41699-13	306	41739-20	262
41606-00	296	41651-40	380	41699-18	306	41740-00	263
41606-00	302	41651-45	380	41699-20	306	41743-32	187
41606-01	296	41651-50	380	41699B18	306	41743-53	187
41606-01	302	41651-55	380	41699C18	306	41743-60	187
41606-02	296	41651-60	380	41699G18	306	41743D32	197
41606-02	302	41651-65	380	41703-38	30	41743D53	197
41607-00	271	41654-80	379	41704G33	263	41743D60	197
41608-00	305	41654-99	379	41704G36	263	41744-32	187
41608-03	305	41659-06	201	41707-32	30	41744-53	187
41608-04	302	41659-07	201	41707-32	257	41744-60	187
41608-04	305	41659-08	201	41707-36	30	41745-30	268
41608-08	305	41660-10	200	41707-36	257	41745-35	268
41608-20	305	41660-15	200	41707-40	30	41745-40	268
41609-36	290	41670-06	102	41707-40	257	41745-50	268
41609-75	290	41670-09	102	41707-45	30	41745-60	268
41609B36	290	41670-AA	102	41707-45	257	41745-65	268
41609C36	290	41670-AB	102	41707-50	30	41746-60	187
41609G36	290	41671-11	102	41707-50	257	41746-60	268
41611-20	296	41672-00	102	41708-32	30	41747-60	187
41614-22	272	41673-00	102	41708-32	257	41747-60	268
41614-33	272	41674-00	102	41708-36	30	41748-20	188
41614-34	272	41675-00	102	41708-36	257	41748-30	188
41614-35	272	41676-00	102	41708-40	30	41748-35	188
41614-36	272	41677-00	102	41708-40	257	41748-40	188
41615-01	336	41678-00	102	41708-45	30	41748-50	188
41615-03	336	41678-14	350	41708-45	257	41750-20	188
41615-05	336	41679-23	342	41708-50	30	41750-30	188
41617-05	273	41680-03	298	41708-50	257	41750-40	188
41617-15	273	41680-06	298	41717-60	30	41750-41	188
41618-14	273	41680-12	298	41717-80	30	41750-50	188
41620-04	336	41681-01	299	41719-32	30	41751-30	187
41628-15	350	41681-02	299	41719-36	30	41751-30	268
41629-17	336	41681-03	299	41719-40	30	41751-35	187
41629-20	336	41681-04	299	41720-18	26	41751-35	268
41629-25	336	41681-06	299	41720-20	26	41751-40	187
41635-02	340	41681-10	299	41720-24	26	41751-40	268

Cod.	pag.	Cod.	pag.	Cod.	pag.	Cod.	pag.
41751-50	187	41767G20	263	41885-30	376	41940-06	393
41751-50	268	41768-21	262	41885-40	376	41940B06	393
41751-60	187	41768-22	262	41885-45	376	41941-43	394
41751-60	268	41769-00	263	41885-50	376	41941-44	394
41751-65	187	41769-01	263	41885-60	376	41944-06	393
41751-65	268	41769-02	263	41900-04	399	41944B06	393
41752-08	268	41769-36	263	41900-10	399	41945-38	393
41752-12	268	41769-50	263	41901-08	398	41960-08	111
41752-24	268	41769G00	263	41901-16	399	41960-10	111
41753-30	187	41770-15	267	41902-04	398	41960-12	111
41753-32	187	41771-96	267	41902-06	398	41960-15	111
41753-53	187	41773-00	105	41903-10	470	41961-10	111
41753-60	187	41774-33	265	41903-10	416	41961-12	111
41753D30	197	41775-34	265	41904-10	399	41961-15	111
41753D32	197	41780-05	258	41905-03	393	41962-10	111
41753D53	197	41780-05	261	41905-38	392	41962-12	111
41753D60	197	41780-07	258	41906-60	393	41962-15	111
41755-11	268	41780-07	261	41907-02	398	41964-45	22
41756-30	187	41780-09	258	41907-04	398	41964-60	22
41756-30	268	41780-09	261	41907-06	398	41980-99	105
41756-32	187	41781-05	261	41907-56	393	41989A00	413
41756-32	268	41781-10	261	41908-00	395	41989A01	413
41756-53	187	41781-15	261	41908-01	395	42400-19	400
41756-53	268	41782-04	301	41908-08	397	42400-25	400
41756-60	187	41782-05	301	41909-13	397	42400-30	400
41756-60	268	41782-06	301	41910-03	399	42401-10	325
41758-53	246	41809-09	415	41910-05	399	42401-15	325
41758-60	246	41810-04	397	41911-02	395	42401-20	325
41758-65	246	41810-09	398	41911-03	395	42403-01	325
41758-85	246	41820-03	347	41911-04	395	42403B01	325
41759-01	244	41820-03	400	41912-03	396	42405-10	325
41759-01	245	41860-36	378	41912-04	396	42405-20	325
41759-02	245	41860-43	378	41913-03	396	42406-35	399
41759-03	245	41860-47	378	41913-04	396	42406-40	399
41759-05	245	41861-44	378	41914-03	22	42413-24	346
41759-09	245	41870-01	372	41916-10	112	42414-05	346
41760-02	245	41870-02	373	41916-15	112	42414-10	346
41760-05	245	41870-03	372	41916-20	112	42414-15	346
41760-06	245	41870-04	373	41917-02	398	42414-20	346
41760-08	245	41875-40	377	41918-01	397	42417-22	346
41760-09	245	41875-61	377	41918-02	397	42420-04	345
41760-20	244	41876-30	377	41918-03	397	42420-04	471
41760-21	244	41876-38	377	41918-04	397	42420-08	345
41760-22	244	41876-45	377	41918-05	397	42420-08	471
41760-26	244	41876-58	377	41919-03	373	42440-30	377
41760-27	244	41877-45	376	41920-03	399	42441-25	377
41761-02	263	41877-61	376	41920-05	399	42442-24	377
41762-07	266	41877-81	376	41922-16	470	42443-06	351
41762-09	266	41877-99	376	41922-22	470	42443-08	351
41762-13	266	41878-45	376	41925-14	113	42443-10	351
41763-00	266	41878-61	376	41925-16	113	42445-03	352
41763-00	433	41878-81	376	41925-18	113	42445-03	378
41763-30	433	41878-99	376	41925-20	113	42445-04	352
41764-28	262	41879-30	377	41925-22	113	42445-05	352
41764-33	262	41879-40	377	41925-24	113	42446-04	352
41764-40	262	41879-50	377	41925-26	113	42450-00	381
41765-32	261	41879-61	377	41929-00	103	42450-AD	383
41765-37	261	41880-38	377	41929-02	103	42451-11	381
41765-41	261	41880-61	377	41930-39	22	42451-12	381
41765-45	261	41881-30	377	41931-08	113	42452-14	382
41765-50	261	41881-40	377	41931-14	113	42452-23	382
41766-14	262	41882-15	377	41931-16	113	42452-35	389
41766-16	262	41882-20	377	41931-18	113	42452-53	381
41766-27	262	41882-25	377	41932-05	113	42452-53	389
41767-20	262	41882-30	377	41933-18	113	42453-23	382

NUMERICAL INDEX INDICE NUMERICO NUMERISCH INDEX INDEX NUMERIQUE INDICE NUMERICO

Cod.	pag.	Cod.	pag.	Cod.	pag.	Cod.	pag.
42460-00	381	42506-10	155	42530-50	156	42560-03	124
42460-06	382	42506-12	155	42531-26	156	42560-04	125
42460-14	382	42506-14	155	42531-32	156	42560-05	125
42460-16	382	42506-16	155	42531-41	156	42560-06	125
42460-18	382	42506-18	155	42531-50	156	42560-07	125
42460-20	382	42507-12	154	42532-29	156	42560-08	125
42460-26	384	42508-00	156	42532-58	156	42560-09	125
42460-27	384	42508-01	156	42533-23	196	42562-12	106
42460-43	383	42509-25	105	42533-26	196	42562-14	106
42460-45	383	42509-50	105	42533-31	196	42562-16	106
42460-53	383	42509-60	105	42533-36	196	42562-18	106
42460-63	384	42509-99	105	42533-40	196	42562-20	106
42460-64	384	42510-00	155	42534-26	156	42562-25	106
42460-74	383	42511-20	154	42534-32	156	42562-30	106
42460-76	383	42511-25	154	42534-41	156	42563-00	119
42461-11	389	42511-30	154	42535-24	159	42563-44	120
42461-35	389	42511-35	154	42535-32	159	42565-00	119
42462-11	386	42511-40	154	42535-49	159	42566-03	118
42462-12	386	42511-56	154	42537-40	158	42569-04	125
42462-13	386	42511-60	154	42537-50	158	42570-32	127
42462-14	386	42511-70	154	42537-80	158	42571-20	127
42462-16	386	42512-35	105	42538-00	158	42572-24	127
42462-23	386	42512-90	439	42538-01	158	42573-31	127
42463-11	386	42512-91	439	42538-02	158	42574-37	127
42463-12	386	42512-92	439	42538-03	158	42575-37	127
42463-13	386	42513-30	105	42538-04	158	42576-00	126
42463-14	386	42513-45	105	42538-05	158	42577-39	126
42463-16	386	42514-20	154	42538-07	158	42579-00	156
42463-23	386	42515-18	154	42538-09	158	42581-01	106
42463A00	375	42515-20	154	42539-00	158	42581-03	106
42463A02	385	42516-18	154	42539-01	158	42581-05	106
42463A04	385	42516-20	154	42539-02	158	42581-10	106
42463A05	385	42517-06	154	42539-03	158	42581-15	106
42463A08	385	42518-01	158	42539-04	158	42581-20	106
42463B00	375	42518-50	159	42539-05	158	42584-01	341
42463B02	385	42519-01	160	42539-07	158	42584-02	341
42463B04	385	42520-00	160	42539-09	158	42584-04	341
42463B05	386	42521-16	158	42540-40	159	42584-05	341
42463B08	386	42521-24	158	42540-50	159	42584-06	341
42470-00	381	42522-00	158	42540-80	159	42584-07	341
42470-06	382	42522-01	158	42541-06	159	42585-00	426
42470-07	382	42522-02	158	42542-00	160	42585-04	426
42470-14	382	42522-03	158	42543-00	159	42585-06	426
42470-16	382	42522-04	158	42543-01	159	42586-09	426
42470-18	382	42522-05	158	42543-02	159	42586-10	426
42470-20	382	42522-07	158	42543-03	159	42587-04	426
42470-26	384	42522-09	158	42543-04	159	42588-00	117
42470-27	384	42523-00	153	42543-05	159	42588-01	117
42470-43	383	42524-06	155	42544-00	159	42589-00	118
42470-45	383	42524-08	155	42544-01	159	42590-01	108
42470-53	383	42524-10	155	42544-02	159	42590-02	108
42470-63	384	42524-12	155	42544-03	159	42590-03	108
42470-64	384	42524-14	155	42544-04	159	42590R01	109
42470-74	383	42524-16	155	42544-05	159	42590R02	109
42470-76	383	42524-18	155	42546-00	158	42590R03	109
42501-15	155	42524-20	155	42546-01	158	42592-01	104
42501-20	155	42524-22	155	42546-02	158	42592-02	104
42502-11	155	42524-30	155	42546-03	158	42593-00	342
42503-10	155	42525-27	155	42546-04	158	42595-01	117
42504-09	105	42526-12	155	42546-05	158	42596-02	117
42505-21	155	42526-14	155	42555-11	258	42597-00	117
42505-24	155	42529-06	154	42556-00	125	42598-00	118
42505-27	155	42530-26	156	42558-00	126	42599-06	119
42505-50	155	42530-32	156	42560-01	124	42599-08	119
42506-08	155	42530-41	156	42560-02	124	42607-05	195

Cod.	pag.	Cod.	pag.	Cod.	pag.	Cod.	pag.
42609-10	108	42667P12	356	42725P10	360	42801P14	355
42609-15	108	42667P18	356	42725S10	360	42801S14	355
42609-20	108	42667P22	356	42727-09	359	42822-00	264
42609-23	108	42667P30	356	42727-12	359	42826-32	264
42609-25	108	42667S12	356	42727-18	359	42826-37	264
42614-04	247	42667S18	356	42727-22	359	42830-08	98
42614-05	247	42667S22	356	42727-30	359	42830-08	145
42614-06	247	42667S30	356	42727-38	359	42830-08	264
42614-07	247	42668P12	357	42728-09	359	42854B25	104
42614-21	195	42668P18	357	42728-12	359	42854B30	104
42615-04	107	42668P22	357	42728-18	359	42854C25	104
42616-04	107	42668P30	357	42728-22	359	42854C30	104
42617-04	326	42668P40	357	42728-30	359	42854G25	104
42617-05	326	42668S12	357	42728-38	359	42854G30	104
42617-06	326	42668S18	357	42728S18	359	42854K25	104
42617-07	326	42668S22	357	42741-22	357	42854K30	104
42623-10	102	42668S30	357	42742-22	357	42854R25	104
42624P10	355	42669C14	360	42746P12	356	42854R30	104
42624S10	355	42669P14	360	42746P18	356	42854Y25	104
42650-10	117	42669S14	360	42746P22	356	42854Y30	104
42650-11	117	42670B14	359	42746P30	356	42863-00	104
42653-04	114	42670N14	359	42746P40	356	42864-10	157
42660-02	355	42670W14	359	42746P50	356	42870-50	386
42661-02	358	42674P18	357	42746P80	356	42870-51	386
42661-03	358	42674P22	357	42746S18	356	42870-59	390
42661-06	358	42674P30	357	42746S22	356	42872-02	391
42662C14	360	42674S18	357	42746S30	356	42873-01	338
42662P14	360	42674S22	357	42747P12	356	42873-02	391
42662S14	360	42674S30	357	42747P18	356	42873-65	384
42663C14	360	42676P15	358	42747S12	356	42874-01	391
42663P14	360	42676P20	358	42747S18	356	42874-02	391
42663S14	360	42676S15	358	42749P18	356	42874-03	391
42664P12	357	42676S20	358	42749P22	356	42874-04	391
42664P18	357	42677P14	357	42749P30	356	42875-17	337
42664P22	357	42677S14	357	42749S18	356	42875-20	337
42664P30	357	42678P14	359	42749S22	356	42875B17	337
42664P40	357	42678S14	359	42764M15	358	42875B20	337
42664S12	357	42678W14	359	42764P16	358	42876-20	337
42664S18	357	42680-13	360	42764P21	358	42876-25	337
42664S22	357	42692B14	355	42764S16	358	42876B20	338
42664S30	357	42693B14	355	42764S21	358	42876B25	338
42665P12	356	42701-10	355	42767P12	358	42877-17	337
42665P18	356	42701P10	355	42767P15	358	42877-25	337
42665P22	356	42702-10	355	42767P20	358	42878-17	336
42665P27	356	42702P10	355	42767S12	358	42878-25	336
42665P30	356	42703-10	355	42767S15	358	42900-15	103
42665P40	356	42703S10	355	42767S20	358	42900-24	103
42665S12	356	42704-10	355	42781-23	357	42901-20	103
42665S18	356	42704S10	355	42781-30	357	42901-25	103
42665S22	356	42705M15	358	42783-23	357	42901-30	103
42665S27	356	42705P10	355	42783-30	357	42901-35	103
42665S30	356	42705P16	358	42785S20	355	42901-40	103
42665S40	356	42705P21	358	42786S20	355	42902-30	104
42666P12	356	42705S10	355	42796P16	359	42902-30	289
42666P18	356	42705S16	358	42796P23	359	42902-31	104
42666P22	356	42705S21	358	42796P30	359	42902-31	289
42666P27	356	42707P21	357	42796S16	359	42902B30	289
42666P30	356	42707S21	357	42796S23	359	42902C30	289
42666P40	356	42709P21	357	42796S30	359	42902G30	289
42666S12	356	42709S21	357	42798P11	359	42903-29	105
42666S18	356	42710-11	357	42798P16	359	42904-01	104
42666S22	356	42720-00	360	42798S11	359	42904-02	104
42666S27	356	42720-01	360	42798S16	359	42904-03	104
42666S30	356	42723P10	360	42800P20	355	42907-01	103
42666S40	356	42723S10	360	42800S20	355	42907-02	103

NUMERICAL INDEX INDICE NUMERICO NUMERISCH INDEX INDEX NUMERIQUE INDICE NUMERICO

Cod.	pag.	Cod.	pag.	Cod.	pag.	Cod.	pag.
42907-03	103	42954-04	352	42974C13	337	44048-99	307
42907-04	103	42954-18	352	42974M13	337	44055-10	303
42907-06	103	42954-29	352	42974N13	337	44055-20	303
42907-07	103	42954-46	352	42975-02	273	44055-25	303
42907-08	103	42955-00	342	42979-00	401	44055-30	303
42907-09	103	42956-19	336	42979-36	401	44055-35	303
42907-10	103	42956-24	336	42979-45	401	44055-40	303
42907-30	103	42956-28	336	42980-01	401	44055-50	303
42907-35	103	42959-12	346	42980-02	401	44055C30	304
42907-40	103	42959-13	346	42981-73	401	44055C40	304
42908-14	114	42962-04	395	42988-99	366	44055G30	304
42908-14	185	42962-26	395	42988C99	366	44055G40	304
42908-24	114	42962-30	395	42988G99	366	44056-01	303
42908-24	185	42962-44	395	42990-16	390	44056-04	303
42920-02	271	42962C26	395	42990-20	390	44056-06	303
42921-00	341	42962C44	395	42990-29	390	44056-11	303
42923-07	271	42963-55	386	42990M16	390	44056-21	303
42924-02	338	42964-53	160	42990M20	390	44057-04	303
42926-12	340	42964-60	160	42990M29	390	44057-06	303
42927-02	339	42965-12	389	42990N16	390	44058-10	302
42928-00	339	42965-AA	390	42990N20	390	44058-10	304
42929-01	340	42965-AB	390	42990N29	390	44058-20	304
42929-02	340	42967-03	387	42991-25	390	44058-25	304
42929-03	340	42967-04	387	42991-32	390	44058-30	304
42931-19	338	42967-05	387	42991M25	390	44058-40	304
42935-19	337	42967-06	387	42991M32	390	44058-50	304
42935-26	337	42967-07	387	42991N25	390	44060-01	302
42936-23	388	42967-08	387	42991N32	390	44060-02	303
42936-24	388	42967-11	389	42993-40	390	44060-50	105
42936-28	388	42967-13	387	42993M40	390	44060-50	302
42939-15	352	42967-14	387	42993N40	390	44060-51	302
42940-03	400	42967-15	387	44009-00	427	44060-80	105
42941-22	352	42967-16	387	44020-21	427	44060-80	302
42942-16	350	42967-17	387	44023-00	426	44060-99	302
42944-23	337	42967-18	387	44024-00	426	44061-08	105
42945-18	337	42967-35	388	44025-50	427	44061-09	105
42945-23	337	42967-43	388	44026-60	441	44061-12	105
42945-27	337	42967-53	388	44027-00	427	44061-14	105
42946-23	388	42967-63	387	44028-19	431	44077-00	448
42946-37	388	42967-64	387	44029-00	427	44077-CC	448
42947-23	389	42967-65	387	44030-03	440	44089-12	451
42947-30	389	42967-66	387	44031-01	440	44093-00	378
42947-40	389	42967-67	387	44031-02	440	44093-01	378
42948-18	337	42967-68	387	44031-04	427	44095-12	451
42948-20	337	42967-73	387	44031-04	440	44095-18	451
42948-23	337	42967-74	387	44031-05	427	44095-30	441
42948-25	337	42967-75	387	44031-05	440	44095-32	441
42949-26	391	42967-76	387	44033-23	432	44096-01	445
42950-01	344	42967-77	387	44033-38	432	44096-02	445
42950-02	344	42967-78	387	44033B23	440	44096-03	445
42950-03	344	42968-38	388	44034-11	432	44096-80	451
42950-04	344	42968-42	388	44040-40	428	44096B80	451
42950-05	344	42969-11	389	44041-00	428	44096G80	451
42950-06	344	42969-31	388	44041-01	428	44096R80	451
42950-07	344	42969-36	388	44041-03	428	44096Y80	451
42950-08	344	42972-01	388	44041-04	428	44097-00	449
42950-09	344	42972-02	388	44041-05	428	44099-03	301
42950-92	344	42972-03	388	44042-00	428	44100-01	301
42950-93	344	42972-04	388	44043-00	428	44100-02	301
42950-94	344	42972-28	388	44044-00	428	44100-04	301
42951-08	352	42973-30	387	44047-17	427	44101-03	301
42951-57	353	42973-45	387	44047-19	427	44102-24	298
42951-59	353	42973-60	387	44047-22	427	44103-03	301
42952-05	352	42973-61	387	44047-25	427	44103-04	301
42953-04	342	42974B13	337	44047-28	427	44103-06	301

<u>Cod.</u>	<u>pag.</u>	<u>Cod.</u>	<u>pag.</u>	<u>Cod.</u>	<u>pag.</u>	<u>Cod.</u>	<u>pag.</u>
44104-01	272	44114-01	304	44201-03	39	44218R40	41
44104-02	272	44114-02	304	44201-10	39	44219R26	41
44104-15	272	44114-03	304	44201B10	39	44220S24	41
44105-00	296	44118-10	305	44201B12	39	44220S32	45
44106-12	301	44118-20	305	44201N10	39	44220S38	45
44106B05	300	44118-25	305	44201N12	39	44221S30	42
44106B10	300	44118-30	305	44201N16	39	44222-20	42
44106B20	300	44118-35	305	44201N20	39	44222-28	42
44106B25	300	44118-40	305	44201N24	39	44222S20	42
44106G05	300	44118-50	305	44201N28	39	44222S28	42
44106G10	300	44119-01	304	44201N32	39	44223S19	44
44106G20	300	44119-02	304	44201O10	39	44223S19	258
44106G25	300	44119-03	304	44201O12	39	44224-22	42
44106O05	300	44119-04	304	44201R10	39	44224S22	42
44106O10	300	44119-06	304	44201R12	39	44225-22	42
44106O20	300	44130-01	303	44201R16	39	44226S30	42
44106O25	300	44130-02	303	44201R20	39	44227-30	42
44106R05	300	44130-03	303	44201R24	39	44228S23	42
44106R10	300	44135-02	303	44201R28	39	44229S20	43
44106R20	300	44141-01	447	44201R32	39	44230S10	43
44106R25	300	44141-03	447	44201V10	39	44230S14	43
44106W05	299	44142-40	447	44201V12	39	44231-14	43
44106W10	299	44147-00	448	44202-10	39	44232S12	43
44106W20	299	44147-01	448	44202B12	39	44232S16	43
44106W25	299	44147-02	448	44202N12	39	44232S20	43
44106Y05	300	44147-03	448	44202N25	40	44233-16	43
44106Y10	300	44148-01	447	44202N27	40	44233-20	43
44106Y20	300	44149-03	446	44202N29	40	44234-12	43
44106Y25	300	44150-19	446	44202O12	39	44234-16	43
44107B05	301	44151-00	446	44202R12	39	44234S12	43
44107B10	301	44151-AA	446	44202R25	39	44234S16	43
44107B20	301	44151-AB	446	44202R27	39	44235-16	43
44107B25	301	44151-AC	446	44202R29	39	44236S28	44
44107G05	300	44160-03	446	44202V12	39	44236S34	44
44107G10	300	44161-00	447	44203R20	39	44237S15	43
44107G20	300	44164-00	447	44203R24	39	44238-15	43
44107G25	300	44165-35	448	44203R28	39	44239R16	40
44107O05	301	44165-40	448	44204R24	40	44240-08	44
44107O10	301	44165-50	448	44204R28	40	44240S08	39
44107O20	301	44166-28	447	44205-16	40	44241-19	43
44107O25	301	44167-13	447	44205-20	40	44242-00	44
44107R05	300	44168-12	449	44205-24	40	44243-00	44
44107R10	300	44169B06	448	44205-28	40	44244S30	45
44107R20	300	44169B14	448	44207-16	40	44244S36	45
44107R25	300	44169R06	448	44207-20	40	44245S32	44
44107W05	300	44169R25	448	44207-24	40	44246S11	45
44107W10	300	44170-00	447	44207-28	40	44246S14	45
44107W20	300	44170-01	447	44208G00	40	44246S17	45
44107W25	300	44171-24	448	44208R00	40	44247-38	40
44107Y05	300	44171-50	448	44209R26	40	44247S16	45
44107Y10	300	44172-30	448	44209R32	40	44248S60	45
44107Y20	300	44173-00	448	44210-26	40	44249S30	44
44107Y25	300	44174-24	445	44210-32	40	44249S35	44
44108-01	298	44175-15	446	44210-42	40	44250S30	44
44108-02	298	44176-30	446	44210S26	40	44250S35	44
44110-00	304	44177-12	446	44210S32	40	44251-01	44
44110-01	304	44178-01	444	44210S42	41	44251-01	345
44110-02	304	44178-02	444	44212-30	41	44251-03	44
44110-03	304	44178-15	444	44213-24	41	44251-03	345
44110-04	304	44178-16	444	44213-36	41	44254-30	45
44110-05	304	44178-17	445	44214-25	41	44255-08	45
44110-06	304	44178-18	445	44215S16	41	44255-10	44
44111-02	304	44178-19	445	44216S16	41	44255-12	44
44112-01	305	44178-20	445	44217-45	41	44255-14	44
44112-02	305	44201-01	39	44218R30	41	44255-15	45

NUMERICAL INDEX INDICE NUMERICO NUMERISCH INDEX INDEX NUMERIQUE INDICE NUMERICO

<u>Cod.</u>	<u>pag.</u>	<u>Cod.</u>	<u>pag.</u>	<u>Cod.</u>	<u>pag.</u>	<u>Cod.</u>	<u>pag.</u>
44255-16	44	44338-06	77	44390-15	48	44466-07	365
44255-21	45	44339-03	77	44390-18	48	44466-11	365
44255-22	45	44339-06	77	44390-23	48	44466-12	365
44256-01	46	44342-06	79	44391-12	48	44466-13	365
44256-02	46	44343-06	79	44394-18	48	44466-14	365
44256-03	46	44344-06	79	44394-21	48	44466-15	365
44256-04	46	44345-06	79	44395-18	48	44466-16	365
44258-60	46	44346-06	79	44397-18	48	44466-30	277
44259-29	46	44347-06	79	44412-00	58	44470-03	370
44260-30	46	44352-30	415	44421-00	58	44470-04	370
44260-34	46	44352-40	415	44422-00	58	44470-11	370
44261-46	46	44355-30	415	44423-00	58	44470-12	370
44262-42	46	44355-40	415	44430-60	187	44470-13	370
44263-36	46	44357-10	336	44430-61	187	44470-14	370
44264-35	46	44357-15	336	44431-46	187	44470-24	370
44265-35	46	44357B10	336	44431-60	187	44470-30	370
44312A06	79	44357B15	336	44432-21	58	44470-40	370
44312B06	79	44366-10	353	44446-10	368	44470-73	370
44312G06	79	44371-24	48	44446-14	368	44470-74	370
44312O06	79	44371-28	48	44446-18	368	44470-75	370
44312R06	79	44371-32	48	44446B10	368	44471-11	334
44312Y06	79	44371-36	48	44446B14	368	44471-12	334
44313B06	79	44371-40	48	44446B18	368	44471-13	334
44313G06	79	44371-44	48	44449-30	368	44471-14	334
44313O06	79	44371-48	48	44449-32	368	44471-24	334
44313R06	79	44372-26	48	44449B30	368	44473-02	333
44313Y06	79	44372-32	48	44449B32	368	44473-03	333
44314A06	79	44372-36	48	44450-11	250	44473-05	333
44314B06	79	44372-40	48	44450-12	250	44473-07	334
44314G06	79	44374-22	48	44450-13	250	44473-08	334
44314O06	79	44374-25	48	44450-15	250	44473-31	333
44314R06	79	44374-32	48	44450-17	250	44473-32	333
44314Y06	79	44374-36	48	44450-21	250	44473-33	333
44315A06	79	44374-40	48	44450-23	250	44473-34	333
44315B06	79	44374-44	48	44450B11	250	44475-76	275
44315G06	79	44375-25	48	44450B12	250	44475-77	275
44315O06	79	44376-40	48	44450B13	250	44475-78	275
44315R06	79	44379-05	336	44450B15	250	44475-79	275
44315Y06	79	44382A06	76	44450B17	250	44475-80	275
44317A06	79	44382B06	76	44450B21	250	44475-81	275
44317B06	79	44382G06	76	44450B23	250	44475-82	275
44317G06	79	44382O06	76	44451-22	250	44475-83	275
44317O06	79	44382Y06	76	44451B22	250	44476-20	373
44317R06	79	44383O06	77	44452-31	249	44476-26	374
44317Y06	79	44383Y06	77	44452B31	249	44476-27	374
44322-02	58	44384A06	77	44453-14	249	44476-28	374
44322-04	58	44384O06	77	44453B14	249	44476-29	374
44322-06	58	44384R06	77	44454-11	249	44476-30	374
44332-03	76	44384Y06	77	44454B11	249	44476-31	374
44332-03	415	44385A06	77	44455-09	249	44476-32	374
44332-06	76	44385B06	77	44455B09	249	44476-33	374
44332-06	415	44385G06	77	44456-14	249	44476-51	374
44332B06	76	44385O06	77	44456B14	249	44476-52	375
44333-03	77	44385R06	77	44457-32	249	44476-53	375
44333-06	77	44385Y06	77	44457B32	249	44477-24	371
44333B06	77	44387A06	77	44459-28	250	44477-25	371
44334-03	77	44387B06	77	44459B28	250	44477-26	371
44334-06	77	44387G06	77	44461-20	250	44477-27	371
44335-03	77	44387O06	77	44461B20	250	44477-28	371
44335-06	77	44387R06	77	44462-25	250	44477-40	371
44335B06	77	44387Y06	77	44462B25	250	44477-41	371
44337-03	77	44389-32	48	44463-11	249	44477-44	371
44337-06	77	44390-07	48	44464-23	249	44477-52	371
44337B06	77	44390-09	48	44465-24	249	44477-53	371
44338-03	77	44390-11	48	44466-07	277	44477-54	371

Cod.	pag.	Cod.	pag.	Cod.	pag.	Cod.	pag.
44477-55	371	44502-02	23	44625-07	430	44839-04	365
44477-64	372	44502-03	23	44625-08	430	44839-05	365
44477-65	372	44502-04	23	44625-26	430	44840-01	362
44477-66	372	44503-01	23	44625-34	430	44840-02	362
44477-67	372	44503-02	23	44625B26	430	44840-03	362
44477-68	372	44503-03	23	44625B34	430	44840-04	362
44477-69	372	44503-04	23	44625G26	430	44840-05	362
44477-76	372	44505-10	437	44625G34	430	44840-06	363
44477-77	372	44505-15	437	44625R26	430	44840-07	363
44477-78	372	44505-20	437	44625R34	430	44840-08	374
44477-79	372	44505-25	437	44625V26	430	44840-10	374
44477-80	372	44506-09	437	44625V34	430	44840-18	374
44477-81	372	44511-27	433	44630-01	134	44840-27	331
44478-20	321	44511-34	433	44630-02	134	44840-27	362
44478-21	321	44511-38	433	44630-03	134	44840-28	331
44478-22	321	44511-42	433	44801-09	439	44840-28	362
44478-23	321	44511-63	433	44801-18	441	44840-30	373
44478-24	321	44511-90	433	44807-18	439	44840-31	373
44478-25	321	44511E21	432	44807-28	439	44840-32	373
44478-26	321	44511E63	432	44807-36	439	44840-40	373
44478-27	321	44511E90	432	44818-11	75	44840-41	373
44478-28	321	44512-34	433	44818-12	75	44840-42	373
44478-29	321	44512-42	433	44818-13	75	44840-50	370
44478-30	321	44512-63	433	44818-14	75	44840-51	370
44478-31	321	44512-90	433	44818-16	75	44840-52	370
44478-32	321	44512E12	432	44819-02	440	44840-55	371
44478-33	321	44512E21	432	44819-03	440	44840-56	371
44478-34	321	44513-34	433	44820-80	440	44840-57	371
44478-35	321	44513-38	433	44820-99	440	44841-18	364
44478-70	371	44513-54	433	44822-80	440	44841-21	364
44478-71	371	44513-63	433	44822-99	440	44841-26	364
44478-72	371	44513-90	433	44825-20	441	44841-37	364
44478-73	371	44513E12	432	44825-40	441	44841-51	364
44478-74	371	44513E21	432	44826-00	440	44841B51	364
44478-75	371	44521-16	433	44826-20	441	44842-30	364
44478-76	371	44521-21	433	44830-52	438	44842-31	364
44478-77	371	44521-31	433	44830-72	438	44842-31	368
44478-78	371	44521E10	433	44830-99	438	44842-35	364
44478-79	371	44522-16	433	44831-52	438	44842-53	364
44478-80	371	44522-21	433	44832-99	438	44842B31	364
44480-00	320	44522-31	433	44833-52	438	44842B31	368
44480-01	320	44522E10	433	44833-99	438	44842B53	364
44480-03	320	44620-01	429	44834-00	367	44843-11	364
44480-04	320	44620-02	429	44834-01	367	44843-12	364
44480-05	320	44620-03	429	44834-02	367	44843-13	364
44480-06	320	44620-04	429	44834-03	367	44843-14	364
44480-07	320	44620-05	429	44834G00	367	44843-24	364
44480-08	320	44620-06	429	44834G01	367	44843B11	364
44480-09	320	44620-07	429	44834G02	367	44843B12	364
44480-10	320	44620-14	429	44834G03	367	44843B13	364
44480-11	320	44620-17	429	44835-36	367	44843B14	364
44480-12	320	44620B14	429	44835-45	367	44843B24	364
44480-13	320	44620B17	429	44835-53	367	44844-01	363
44480-14	320	44620G14	429	44835G36	367	44844-11	364
44480-15	321	44620G17	429	44835G45	367	44844B01	363
44480-16	321	44620R14	429	44835G53	367	44845-30	365
44480-17	321	44620R17	429	44836-30	366	44845-31	274
44480-18	321	44620V14	429	44836G30	367	44845-38	274
44480-19	321	44620V17	429	44837-05	382	44845-41	365
44480-20	321	44620Y14	429	44837-20	382	44845-51	365
44501-01	23	44620Y17	429	44837-25	382	44846-05	363
44501-02	23	44625-03	430	44837B05	382	44846-09	363
44501-03	23	44625-04	430	44837B20	382	44846-13	363
44501-04	23	44625-05	430	44837B25	382	44846-15	363
44502-01	23	44625-06	430	44837C20	383	44846B05	363

NUMERICAL INDEX INDICE NUMERICO NUMERISCH INDEX INDEX NUMERIQUE INDICE NUMERICO

Cod.	pag.	Cod.	pag.	Cod.	pag.	Cod.	pag.
44846B09	363	44884-12	363	44947-00	158	44992-02	326
44846B13	363	44884-19	363	44947-07	117	44992-03	326
44846B15	363	44884-25	363	44950-15	336	44993-01	326
44847-09	363	44884B12	364	44950-20	336	44994-00	326
44847-13	363	44884B19	364	44950-25	336	44995-10	326
44847-20	363	44884B25	364	44950-30	336	44995-14	326
44847B09	362	44885-19	364	44950-38	336	44995-15	326
44847B13	362	44885-25	364	44960-04	265	44997-22	106
44847B20	362	44886-30	369	44960-06	265	44997-24	106
44849-27	366	44886-34	369	44961-02	435	44997-26	106
44849-34	366	44886-36	369	44961-03	265	44997-28	106
44849-47	366	44886-38	369	44961-03	435	44998-31	106
44850-00	366	44886-44	369	44961-04	434	44999-09	325
44850-10	365	44887-32	369	44961-05	434	44999-16	325
44850-11	365	44887-36	369	44968-00	435	46970-18	25
44850-12	366	44888-32	369	44970-10	434	46970-25	25
44850-13	252	44888-35	369	44970-15	434	47005-24	203
44850-13	366	44888-40	369	44970-20	434	47006-25	203
44850B00	366	44889-32	369	44970-34	434	47007-26	208
44850B10	365	44889-35	369	44972-20	434	47010-20	185
44850B11	365	44889-40	369	44972-25	434	47011-01	197
44850B12	366	44930-10	437	44972-33	434	47014-35	205
44850B13	252	44930-20	437	44973-10	434	47018-30	205
44850B13	366	44932-15	437	44973-20	434	47018-50	205
44850G12	366	44932-20	437	44974-21	434	47020-15	184
44850W00	366	44934-30	437	44974-27	434	47020-20	184
44851-01	366	44936-02	437	44974-31	434	47020-30	184
44851-02	366	44936-20	437	44975-35	436	47020-35	184
44851-03	366	44936-57	437	44975-50	436	47021-30	184
44871-20	295	44940-01	293	44975C50	426	47021-35	184
44871-21	295	44940-02	293	44975C50	435	47021-45	184
44871-22	295	44940-06	293	44975H35	436	47022-12	195
44871-23	295	44940-08	293	44975H50	436	47023-01	271
44871-30	325	44940-10	293	44976-01	436	47023-02	271
44871-31	325	44940-11	294	44976-02	436	47023-03	271
44873-08	274	44940-12	294	44976-03	436	47023-04	271
44873-16	274	44940-13	294	44976-04	435	47024-06	192
44874-08	275	44940-14	294	44977-12	437	47024-10	192
44874-16	275	44940-16	294	44978-10	434	47025-06	192
44877-11	74	44940-17	294	44978-20	434	47025-10	192
44877-12	74	44940-18	294	44979-02	435	47026-06	192
44877-13	75	44940-19	294	44979-04	435	47027-11	193
44877-14	75	44940-24	294	44979-05	435	47027-12	193
44877-16	75	44940-25	294	44979-06	435	47027-13	193
44877-24	74	44940-26	294	44982-04	247	47027-14	193
44877B11	74	44940-32	295	44982-04	432	47027-15	193
44877B12	74	44940-33	295	44982-06	247	47027-16	193
44877B13	75	44940-34	295	44982-06	432	47028-12	192
44877B14	75	44942-01	295	44982-10	247	47029-12	192
44877B16	75	44942-02	295	44982-10	432	47030-30	193
44877B24	74	44942-03	295	44986-12	434	47031-44	190
44878-11	74	44942-04	295	44986-17	434	47031-46	190
44878-12	74	44942-05	296	44986-21	434	47032-10	193
44878-13	75	44942-06	277	44986-28	434	47032-20	193
44878-14	75	44942-07	277	44987-11	435	47033-08	193
44878-16	75	44942-10	277	44987-60	435	47033-12	193
44878-24	74	44942-11	277	44987C11	435	47033-14	193
44878B11	74	44942-12	277	44987C60	435	47033-50	190
44878B12	74	44944C07	284	44987C62	434	47034-23	193
44878B13	75	44944G07	284	44987C62	435	47034-50	193
44878B14	75	44945C05	284	44990-15	295	47034-51	193
44878B16	75	44945G05	284	44990-24	295	47034-52	193
44878B24	74	44946-04	401	44990-29	295	47035-40	193
44882-35	369	44946-05	401	44990-36	295	47035-48	193
44882-46	369	44946B05	401	44990-48	295	47036-30	193

<u>Cod.</u>	<u>pag.</u>	<u>Cod.</u>	<u>pag.</u>	<u>Cod.</u>	<u>pag.</u>	<u>Cod.</u>	<u>pag.</u>
47036-35	193	47069-18	201	47119-30	185	47251-03	183
47036-40	193	47069-20	201	47119-35	185	47301-12	164
47036-45	193	47070-37	196	47119-40	185	47302-10	164
47036-50	193	47070-48	196	47119-45	185	47303-10	164
47036-60	193	47070-60	196	47119-50	185	47304-06	164
47037-30	193	47075-20	195	47119-60	185	47304-10	164
47037-40	193	47075-30	195	47120-01	184	47304-12	164
47038-50	193	47075-45	195	47120-02	184	47305-12	164
47038-60	193	47090-23	273	47127-04	180	47306-10	164
47039-05	194	47091-01	273	47127-06	180	47307-10	164
47039-10	194	47091-02	273	47127-08	180	47308-10	164
47039-15	194	47093-24	117	47130-25	197	47310-10	164
47040-00	247	47094-30	186	47130-30	197	47312-10	164
47041-01	246	47098-18	187	47130-35	197	47314-10	164
47041-02	246	47098-22	187	47130-40	197	47315-10	164
47041-03	246	47098-26	187	47130-45	197	47316-10	164
47041-04	246	47098-30	187	47130-50	197	47316-12	164
47041-05	246	47099-30	274	47130-55	197	47316-20	164
47041-06	246	47100-03	400	47130-60	197	47317-10	164
47041-07	246	47100-04	400	47131-30	197	47317-12	165
47041-08	246	47100-05	400	47131-60	197	47317-20	165
47041-15	246	47100-06	400	47200-01	183	47321-12	165
47042-19	247	47100-07	400	47200-02	183	47322-12	165
47042-22	247	47100-08	400	47207-20	180	47323-12	165
47042-25	247	47101-30	186	47207-25	180	47324-12	165
47043-27	247	47101-31	274	47207-30	180	47325-10	165
47043-35	247	47101-40	186	47208-01	179	47326-10	165
47043-42	247	47103-30	186	47208-02	179	47327-12	165
47060-06	201	47103-32	186	47208-03	179	47328-15	165
47060-07	201	47104-45	185	47208-04	179	47331-15	165
47060-09	201	47105-28	184	47208-05	179	47332-12	165
47060-10	201	47105-34	184	47208-06	179	47333-15	165
47060-12	201	47105-40	184	47208-07	179	47334-12	165
47060-14	201	47105-46	184	47208-08	179	47335-12	165
47060-16	201	47105-50	184	47208-09	179	47336-42	165
47060-18	201	47105-55	184	47208-10	179	47350-01	179
47060-20	201	47105-60	184	47208-11	179	47351-01	179
47060-22	201	47105-65	184	47208-12	179	47352-01	179
47060-24	201	47105-70	184	47208-13	179	47353-02	180
47060-26	201	47105-75	184	47208-14	179	47353-04	180
47060-30	201	47106-28	184	47208-15	179	47353-06	180
47062-18	201	47106-34	184	47208-16	179	47353-08	180
47062-20	201	47106-40	184	47208-17	180	47353-10	180
47062-22	201	47106-46	184	47208-18	180	47353-12	180
47063-01	201	47106-50	184	47208-19	180	47353-14	180
47063-02	201	47106-55	184	47208-20	180	47353-16	180
47063-05	201	47106-60	184	47208-21	180	47353-18	180
47063-07	201	47106-65	184	47208-22	180	47353-20	180
47063-10	201	47106-70	184	47208-23	180	47353-22	180
47064-18	201	47106-75	184	47208-24	180	47353-24	180
47064-22	201	47107-00	186	47212-01	183	47354-02	180
47064-26	201	47108-00	186	47212-02	183	47354-04	180
47064-30	201	47110-23	186	47212-03	183	47354-06	180
47066-03	201	47111-30	185	47212-05	183	47354-08	180
47066-04	201	47111-40	185	47214-86	181	47354-10	180
47066-05	201	47111-46	185	47215-86	181	47354-12	180
47066-06	201	47111-55	185	47216-88	181	47354-14	180
47066-07	201	47112-34	185	47219-29	182	47354-16	180
47066-08	201	47112-45	185	47219-38	182	47354-18	180
47068-12	201	47112-50	185	47219-55	182	47355-02	180
47068-15	201	47113-03	186	47250-12	181	47355-04	180
47069-10	201	47118-30	185	47250-24	181	47355-06	180
47069-12	201	47118-40	185	47251-00	182	47355-08	180
47069-14	201	47118-55	185	47251-01	182	47355-10	180
47069-16	201	47118-65	185	47251-02	183	47355-12	180

NUMERICAL INDEX INDICE NUMERICO NUMERISCH INDEX INDEX NUMERIQUE INDICE NUMERICO

Cod.	pag.	Cod.	pag.	Cod.	pag.	Cod.	pag.
47356-02	180	47377-12	172	47510-13	200	47533-14	197
47356-04	180	47377-15	172	47510-15	200	47533-16	197
47356-06	180	47378-01	171	47510-17	200	47533-18	197
47356-08	180	47378-02	171	47510-19	200	47533-20	197
47356-10	180	47378-08	166	47510-21	200	47533-22	197
47356-12	180	47379-08	166	47510-23	200	47533-24	197
47356-14	180	47380-08	170	47510-25	200	47533-26	197
47356-16	180	47381-08	171	47510-27	200	47533-28	197
47356-18	180	47382-06	170	47510-29	200	47533-30	197
47357-01	178	47382-08	168	47510-31	200	47533-32	197
47357-02	178	47383-08	170	47511-07	200	47534-00	198
47357-03	178	47384-01	170	47511-09	200	47534-01	198
47357-06	177	47384-08	170	47511-11	200	47534-06	198
47357-07	177	47385-01	171	47511-13	200	47534-07	198
47357-08	177	47385-08	171	47511-15	200	47534-08	198
47357-09	177	47386-08	170	47511-17	200	47534-09	198
47357-10	178	47387-01	167	47511-19	200	47534-10	198
47357-11	178	47387-02	168	47511-21	200	47534-16	198
47357-20	175	47388-06	172	47511-23	200	47534-18	198
47357-21	175	47388-07	172	47511-25	200	47534-20	198
47357-22	175	47388-08	172	47511-27	200	47534-22	198
47357-23	176	47401-08	170	47511-29	200	47534-24	198
47357-24	175	47402-01	167	47511-31	200	47534-26	198
47357-25	176	47402-02	168	47512-07	200	47534-28	198
47357-26	176	47402-08	167	47512-09	200	47535-09	200
47357-27	176	47404-01	170	47512-11	200	47535-12	200
47357-28	176	47404-02	170	47512-13	200	47535-15	200
47357-29	176	47404-03	170	47512-15	200	47535-17	200
47357-30	177	47404-04	170	47512-17	200	47535-19	200
47357-31	177	47404-05	170	47512-19	200	47536-12	200
47357-38	182	47404-08	170	47512-21	200	47536-14	200
47357-40	181	47411-01	167	47512-23	200	47536-16	200
47357-41	181	47411-02	167	47512-25	200	47536-18	200
47357-42	181	47411-03	167	47512-27	200	47536-20	200
47357-43	181	47411-08	166	47512-29	200	47538-20	199
47357-44	181	47412-08	166	47512-31	200	47538-23	199
47357-50	181	47413-01	167	47526-05	198	47538-26	199
47357-51	181	47413-08	167	47527-55	199	47540-02	199
47370-01	171	47414-03	165	47528-05	198	47540-03	199
47370-02	171	47415-03	165	47529-07	198	47540-04	199
47370-03	171	47416-06	165	47530-14	198	47540-05	199
47370-08	166	47417-06	166	47530-16	198	47541-02	199
47370-08	168	47418-00	166	47530-18	198	47541-03	199
47371-08	170	47419-10	165	47530-20	198	47541-04	199
47372-08	167	47421-09	172	47530-22	198	47542-00	198
47373-01	168	47422-26	172	47530-24	198	47542-18	199
47373-02	171	47425-01	172	47530-26	198	47542-20	199
47373-08	168	47425-02	172	47530-28	198	47542-22	199
47374-01	171	47425-03	172	47530-30	198	47542-24	199
47374-02	171	47425-04	172	47532-06	198	47542-26	199
47374-08	171	47425-05	172	47532-07	198	47544-20	199
47375-01	170	47425-06	172	47532-08	198	47544-25	199
47375-08	170	47425-08	172	47532-12	198	47544-30	199
47376-08	168	47425-09	172	47532-14	198	47546-18	199
47377-01	169	47425-10	172	47532-16	198	47546-21	200
47377-02	169	47425-11	172	47532-18	198	47546-22	200
47377-03	169	47425-26	172	47532-20	198	47546-23	200
47377-04	169	47425-29	172	47532-22	198	47546-30	199
47377-05	169	47425-30	172	47532-24	198	47546-40	199
47377-06	169	47425-32	172	47532-26	198	47546-41	200
47377-07	169	47426-01	172	47533-07	197	47546-42	200
47377-08	166	47426-07	172	47533-08	197	47546-43	200
47377-09	168	47510-07	200	47533-09	197	47546-51	200
47377-10	168	47510-09	200	47533-10	197	47546-52	200
47377-11	169	47510-11	200	47533-12	197	47546-53	200

Cod.	pag.	Cod.	pag.	Cod.	pag.	Cod.	pag.
47547-22	199	47621-03	194	47657-04	212	47686-17	186
47547-26	199	47621-04	194	47657-05	212	47686-22	186
47547-30	199	47621-05	195	47657-07	212	47686-24	186
47548-02	199	47621-06	195	47658-01	212	47686-26	186
47548-03	199	47621-07	195	47658-02	212	47686-30	186
47548-04	199	47621-08	195	47658-03	212	47686-33	186
47548-05	199	47621-11	266	47658-04	212	47686-36	186
47600-16	111	47621-12	266	47658-05	212	47686-42	186
47600-20	111	47622-01	174	47658-07	212	47687-24	186
47600-24	111	47622-02	174	47659-01	208	47688-60	196
47600-28	111	47622-03	174	47659-02	208	47689-53	197
47600-32	111	47622-04	173	47659-03	208	47689-60	197
47600-36	111	47622-26	173	47659-04	208	47691-53	197
47600-40	111	47625-03	195	47670-02	208	47691-64	197
47603-25	106	47626-55	190	47672-05	208	47692-01	191
47603-27	106	47627-01	190	47674-01	209	47692-02	191
47604-08	106	47630-28	174	47674-02	209	47692-03	191
47604-10	106	47631-08	174	47674-03	209	47693-00	191
47604-12	106	47631-12	174	47674-04	209	47693-03	191
47604-15	106	47640-25	194	47674-05	209	47693-05	191
47604-18	106	47640-35	194	47674-06	209	47693-10	191
47604-20	106	47642-30	194	47674-07	209	47693-15	191
47604-24	106	47642-40	194	47674-08	209	47694-03	188
47604-30	106	47642-50	194	47675-01	210	47698-03	189
47605-23	105	47642-60	194	47675-02	210	47698-03	471
47606-02	106	47642-70	194	47675-03	210	47698-06	189
47606-05	106	47643-30	194	47675-04	210	47698-06	471
47606-10	106	47643-40	194	47675-05	210	47705-22	204
47606-20	106	47643-50	194	47675-06	210	47709-20	203
47606-30	106	47643-60	194	47675-07	211	47709-24	203
47606-50	106	47643-70	194	47675-08	211	47709-28	203
47607-10	106	47644-15	194	47675-09	211	47709-32	203
47607-20	106	47645-40	194	47677-01	209	47710-12	203
47608-02	106	47645-60	194	47677-02	209	47710-16	203
47609-02	107	47645-75	194	47677-03	209	47710-20	203
47609-03	107	47646-40	194	47677-04	209	47710-24	203
47609-04	107	47646-60	194	47677-05	209	47710-28	203
47609-07	107	47646-75	194	47677-06	209	47710-32	203
47609-09	107	47651-01	211	47677-07	209	47711-08	203
47609-12	107	47651-02	211	47677-08	209	47711-12	203
47609-13	107	47651-03	211	47677-09	210	47711-22	203
47609-16	107	47651-04	211	47677-10	210	47711-24	203
47610-18	111	47651-05	211	47677-11	210	47711-26	203
47610-22	110	47651-07	211	47677-12	210	47712-20	203
47610-26	110	47652-01	211	47677-13	210	47712-24	203
47610-30	110	47652-02	211	47677-14	210	47712-28	203
47611-01	111	47652-03	211	47677-15	210	47712-32	203
47611-03	111	47652-04	211	47677-16	210	47713-22	204
47611-05	111	47652-05	211	47677-17	210	47714-26	204
47611-06	111	47652-07	211	47677-18	210	47714-28	204
47611-09	111	47655-01	211	47677-19	210	47715-30	204
47611-11	111	47655-02	211	47677-20	210	47716-37	205
47611-13	111	47655-03	211	47679-10	195	47717-35	204
47611-14	111	47655-04	211	47680-40	196	47718-20	204
47611-15	111	47655-05	211	47680-53	196	47719-10	204
47611-16	111	47655-07	211	47680-60	196	47719-24	204
47611-19	111	47656-01	211	47681-60	197	47720-06	206
47611-23	111	47656-02	211	47682-53	196	47720-08	206
47612-01	188	47656-03	211	47682-60	196	47720-10	206
47614-25	195	47656-04	211	47684-15	208	47720-12	206
47615-25	195	47656-05	211	47685-53	196	47721-08	206
47618-10	181	47656-07	211	47685-60	196	47721-10	206
47618-20	181	47657-01	212	47686-10	186	47721-12	206
47621-01	194	47657-02	212	47686-12	186	47722-05	206
47621-02	194	47657-03	212	47686-14	186	47722-06	206

NUMERICAL INDEX INDICE NUMERICO **NUMERISCH INDEX** INDEX NUMERIQUE **INDICE NUMERICO**

Cod.	pag.	Cod.	pag.	Cod.	pag.	Cod.	pag.
47722-07	206	47740116	240	47740-53	241	47742-09	227
47722-08	206	47740117	240	47740-55	236	47742-10	228
47722-10	206	47740118	240	47740-56	237	47742-12	226
47723-05	206	47740119	232	47740-57	233	47742-13	227
47723-05	207	47740-12	239	47740-58	233	47742-14	227
47723-06	206	47740121	235	47740-59	233	47742-15	228
47723-07	206	47740122	234	47740-60	232	47742-16	228
47723-08	206	47740123	234	47740-61	232	47742-17	227
47723-10	206	47740124	234	47740-62	237	47742-19	227
47723-12	206	47740125	233	47740-63	237	47742-20	227
47724-06	206	47740127	233	47740-64	237	47742-21	227
47724-08	206	47740128	231	47740-65	237	47742-23	227
47724-10	206	47740129	240	47740-66	237	47742-24	227
47724-11	206	47740-13	236	47740-67	239	47742-25	227
47725-09	206	47740130	234	47740-68	235	47742-27	226
47726-07	205	47740131	235	47740-69	232	47742-29	228
47727-07	205	47740132	233	47740-70	232	47742-30	226
47728-06	205	47740133	235	47740-71	237	47742-31	226
47730-24	206	47740134	241	47740-72	237	47742-33	227
47730-36	206	47740135	232	47740-73	241	47742-34	227
47730-60	206	47740136	231	47740-74	232	47742-37	227
47731-12	207	47740137	231	47740-75	232	47742-41	226
47732-20	207	47740138	231	47740-76	232	47742-42	227
47733-18	204	47740139	233	47740-77	234	47742-47	228
47733-24	204	47740-14	240	47740-78	234	47742-48	228
47733-30	204	47740140	233	47740-79	238	47742-51	227
47733-36	204	47740141	231	47740-80	231	47742-56	227
47734-18	204	47740142	235	47740-81	236	47742-61	228
47735-18	204	47740143	235	47740-82	235	47743-65	241
47736-30	205	47740144	234	47740-83	232	47744-10	243
47736-35	205	47740145	238	47740-84	239	47744-19	243
47736-40	205	47740-15	238	47740-85	237	47744-21	243
47736-50	205	47740-16	233	47740-86	240	47744-30	242
47738-23	204	47740-17	235	47740-87	238	47744-31	242
47739-12	203	47740-18	232	47740-88	240	47744-32	242
47739-24	203	47740-19	235	47740-89	234	47744-33	242
47739-28	203	47740-20	238	47740-90	239	47744-34	242
47739-32	203	47740-23	231	47740-91	239	47744-36	243
47740-01	238	47740-24	237	47740-92	236	47744-37	243
47740-02	233	47740-25	237	47740-93	232	47744-48	243
47740-03	234	47740-26	231	47740-94	234	47744-58	242
47740-04	236	47740-27	231	47740-95	233	47744-59	243
47740-05	237	47740-28	231	47740-96	240	47744-60	243
47740-06	232	47740-29	231	47740-97	235	47744-62	243
47740-07	239	47740-30	237	47740-98	239	47744-63	243
47740-08	239	47740-31	239	47740-99	238	47744-70	243
47740-09	238	47740-32	236	47740-AA	240	47744-71	243
47740-10	233	47740-33	239	47740-AB	241	47744-80	242
47740100	238	47740-34	235	47740-AC	241	47744-81	242
47740101	234	47740-35	241	47740-AD	241	47745-01	224
47740102	232	47740-36	237	47741121	241	47745-02	224
47740103	232	47740-37	234	47741-37	242	47745-03	224
47740104	236	47740-38	233	47741-38	242	47745-04	224
47740105	231	47740-39	237	47741-76	241	47745-05	224
47740106	235	47740-41	234	47741-77	242	47745-06	222
47740107	239	47740-43	233	47741-78	242	47745-07	222
47740108	240	47740-44	236	47742-00	229	47745-08	222
47740109	240	47740-45	237	47742-01	228	47745-09	222
47740-11	239	47740-46	236	47742-02	226	47745-10	223
47740110	240	47740-47	236	47742-03	228	47746-01	223
47740111	236	47740-48	236	47742-04	228	47746-02	223
47740112	241	47740-49	236	47742-05	227	47746-03	223
47740113	241	47740-50	235	47742-06	228	47746-04	223
47740114	238	47740-51	238	47742-07	227	47746-05	223
47740115	238	47740-52	232	47742-08	227	47746-06	223

Cod.	pag.	Cod.	pag.	Cod.	pag.	Cod.	pag.
47746-07	224	47783-11	213	47842-00	190	47860-92	219
47746-08	224	47783-12	213	47843-00	130	47860-93	219
47746-09	224	47783-13	213	47843-00	190	47860-94	219
47747-01	206	47783-14	213	47844-01	189	47860-95	215
47747-03	206	47793-11	220	47844-02	189	47860-96	215
47747-04	206	47793-12	220	47844-06	189	47862-03	216
47747-05	207	47793-13	220	47844-06	472	47862-04	216
47747-06	206	47793-15	220	47846-10	188	47862-05	216
47747-07	207	47793-16	220	47847-10	188	47862-06	216
47747-09	207	47793-17	220	47847-10	472	47862-07	216
47747-10	206	47793-18	220	47847-12	188	47862-08	216
47747-11	206	47793-19	220	47847-12	472	47862-09	216
47748-35	207	47793-20	220	47847-23	188	47862-10	217
47749-35	207	47793-21	220	47848-07	189	47862-31	216
47750-06	207	47793-22	221	47848-07	471	47862-32	216
47751-23	203	47793-23	221	47859-01	271	47862-33	216
47752-09	205	47793-24	221	47859-02	271	47862-34	216
47752-16	205	47793-25	221	47859-03	271	47862-35	216
47752-21	205	47793-26	221	47860-17	213	47862-36	216
47753-31	205	47793-27	221	47860-18	213	47862-38	216
47754-20	208	47793-32	221	47860-21	213	47862-39	216
47754-24	208	47793-33	221	47860-24	213	47862-70	217
47754-26	208	47793-40	221	47860-27	213	47862-71	217
47754-28	208	47793-41	221	47860-31	213	47862-72	217
47755-26	208	47793-42	221	47860-35	213	47862-73	217
47756-20	208	47793-43	221	47860-36	213	47862-74	217
47756-24	208	47793-44	221	47860-37	213	47862-75	217
47756-26	208	47793-45	221	47860-38	214	47862-76	217
47756-28	208	47793-51	221	47860-39	214	47862-77	217
47757-65	205	47793-52	221	47860-40	214	47862-80	219
47757-80	205	47793-53	221	47860-42	214	47862-81	219
47758-10	204	47793-54	221	47860-43	214	47862-82	219
47758-12	204	47793-55	221	47860-44	214	47862-83	219
47759-12	205	47800-22	188	47860-46	214	47862-84	219
47760-12	205	47801-20	188	47860-48	214	47862-85	219
47761-23	207	47820-05	192	47860-49	214	47862-86	219
47762-23	207	47820-07	192	47860-50	214	47862C10	217
47763-31	207	47821-05	192	47860-53	214	47863-01	218
47764-12	208	47821-07	192	47860-55	214	47863-02	218
47764-28	208	47822-05	192	47860-56	214	47863-03	218
47765-24	228	47822-07	192	47860-57	214	47863-04	218
47765-26	228	47830-05	192	47860-58	214	47865-23	219
47765-28	228	47830-07	192	47860-60	214	47865-44	219
47766-26	228	47831-02	108	47860-61	214	47865-66	220
47766-28	228	47831-02	174	47860-62	214	47865-71	220
47766-30	228	47832-00	392	47860-63	215	47865-72	220
47770-21	228	47832-01	392	47860-66	215	47865-73	220
47771-28	228	47832-02	392	47860-67	215	47865-74	220
47773-24	229	47832-03	392	47860-68	215	47865-75	220
47773-28	229	47832-04	392	47860-69	215	47865-76	220
47775-01	225	47832-05	392	47860-70	215	47865-77	220
47775-02	225	47832-10	392	47860-71	215	47865-80	219
47775-03	225	47832-11	392	47860-73	215	47865-81	219
47775-04	225	47832-12	392	47860-74	215	47865-82	219
47775-05	225	47832-13	392	47860-75	215	47865-83	219
47775-06	225	47832-14	392	47860-76	217	47870-17	218
47775-08	225	47832-15	392	47860-77	217	47870-18	218
47775-09	225	47833-04	174	47860-78	217	47870-19	218
47775-10	225	47833-10	174	47860-81	215	47875-11	212
47775-11	226	47837-09	174	47860-83	215	47875-13	212
47775-12	226	47838-00	190	47860-84	215	47875-14	212
47783-01	212	47840-11	189	47860-85	215	47876-11	219
47783-02	212	47840-11	471	47860-86	217	47876-12	219
47783-03	212	47841-03	189	47860-90	219	47876-13	219
47783-04	212	47841-04	189	47860-91	219	47876-14	219

NUMERICAL INDEX INDICE NUMERICO NUMERISCH INDEX INDEX NUMERIQUE INDICE NUMERICO

<u>Cod.</u>	<u>pag.</u>	<u>Cod.</u>	<u>pag.</u>	<u>Cod.</u>	<u>pag.</u>	<u>Cod.</u>	<u>pag.</u>
47876-15	219	48278-15	94	48280-04	86	48283-03	122
47876-16	219	48278-16	93	48280-05	86	48283-04	122
47876-17	219	48278-17	93	48280-06	88	48283-05	122
47876-18	219	48278-18	96	48280-08	89	48284-00	122
47885-01	123	48278-19	96	48280-09	87	48285-04	120
47885-02	123	48278-20	92	48280-10	88	48285-05	120
47885-03	123	48278-21	92	48280-10	116	48286-01	123
47885-04	123	48278-24	90	48280-11	89	48286-03	122
47885-05	124	48278-25	93	48280-12	87	48286-05	122
48017-14	145	48278-27	95	48280-13	87	48286-08	123
48017-25	145	48278-28	96	48280-15	89	48286-13	122
48021-21	145	48278-31	92	48280-20	86	48286-18	123
48032-30	153	48278-32	90	48280-21	86	48286-62	118
48032-45	153	48278-33	90	48280-22	87	48286-64	118
48032-60	153	48278-34	93	48280-23	90	48286-66	118
48039-06	153	48278-35	93	48280-24	88	48286-67	88
48040-00	153	48278-36	94	48280-25	90	48286-68	346
48040-10	153	48278-37	92	48280-25	151	48286-70	120
48040-50	153	48278-38	91	48280-26	88	48287-18	378
48040-AA	153	48278-39	90	48280-27	151	48287-19	378
48040-AA	153	48278-41	91	48280-30	88	48289-10	117
48210-00	346	48278-42	91	48280-31	88	48290-10	247
48211-00	346	48278-45	92	48280-32	86	48294-01	124
48215-14	145	48278-46	91	48280-34	89	48294-02	124
48215-30	145	48278-47	93	48280-34	151	48294-03	124
48218-00	116	48278-48	91	48280-34	151	48294-04	124
48220-00	126	48278-49	91	48280-35	88	48295-10	119
48222-01	126	48278-52	93	48280-36	88	48300-29	254
48223-00	306	48278-53	93	48280-37	87	48300-33	254
48231-40	156	48278-54	93	48280-38	86	48300-33	307
48231-45	156	48278-55	91	48280-39	86	48300-42	254
48231-50	156	48278-61	95	48280-41	87	48300-42	307
48236-00	338	48278-62	95	48280-45	86	48300-43	254
48236-01	338	48278-63	95	48280-45	264	48300-43	307
48237-00	338	48278-64	94	48280-46	87	48306-01	307
48237-01	338	48278-65	95	48280-47	89	48307-01	154
48237-35	338	48278-66	94	48280-48	86	48307-02	154
48237-99	338	48278-68	94	48280-49	87	48307-03	154
48238-00	346	48278-69	94	48280-52	89	48310-14	287
48239-00	346	48278-71	95	48280-53	89	48310-20	287
48240-00	346	48278-73	95	48280-54	88	48311-20	287
48241-14	353	48278-74	95	48280-56	302	48311-25	287
48242-09	353	48278-75	92	48280-59	87	48312-25	287
48244-04	353	48278-76	95	48280-60	89	48313-14	288
48244-07	353	48278-77	92	48280-61	89	48313-18	288
48245-10	353	48278-81	96	48280-62	89	48313-20	288
48245-75	353	48278-82	96	48280-63	89	48350-01	278
48247-10	353	48278-83	96	48280-75	87	48350-02	278
48249-13	354	48278-84	96	48280-85	89	48350-03	278
48250-10	353	48278-85	96	48280-90	90	48350-04	278
48250-12	353	48278-87	91	48280-91	90	48351-01	278
48251-03	354	48278-88	96	48280-92	90	48351-02	278
48252-10	354	48278-89	96	48280-92	151	48351-03	278
48252-12	354	48278-91	94	48280-92	302	48352-01	278
48252B10	354	48278-92	94	48280-94	87	48352-02	278
48252B12	354	48278-93	95	48280-95	90	48352-03	278
48253-09	354	48278-94	92	48280-96	89	48353-01	278
48253B09	354	48278-95	93	48280-96	302	48353-01	307
48278-01	92	48278-96	93	48280-97	89	48354-01	278
48278-02	92	48278-99	94	48281-22	119	48354-01	307
48278-03	93	48280-02	88	48281-23	119	48355-01	308
48278-11	94	48280-02	151	48282-21	119	48356-01	308
48278-12	91	48280-02	302	48283-00	122	48357-01	308
48278-13	91	48280-03	88	48283-01	122	48358-01	308
48278-14	96	48280-03	126	48283-02	122	48359-01	308

Cod.	pag.	Cod.	pag.	Cod.	pag.	Cod.	pag.
48360-01	308	49373-90	431	49617-25	259	49655-64	256
48361-01	308	49378-00	441	49617-30	259	49655-65	256
48362-01	307	49378-48	452	49618-12	258	49656-02	257
48363-01	307	49379-00	442	49618-15	258	49656-15	255
48364-09	307	49381-01	431	49618-18	258	49656-16	255
48364-12	307	49381-02	431	49626-00	255	49656-20	255
48365-09	278	49381-03	431	49626-02	255	49657-15	257
48366-09	278	49382-10	431	49627-22	254	49657-20	257
48501-76	160	49382-23	431	49628-00	254	49657-25	257
48505-01	160	49382-47	431	49629-45	259	49658-01	254
48505-02	160	49384-03	431	49630-06	458	49658-02	254
48505-03	160	49384-04	431	49630-08	458	49701-00	131
48506-01	160	49384-05	431	49632-24	258	49702-00	130
48506-02	160	49384-06	431	49632-32	258	49703-00	133
48506-03	160	49384-07	431	49633-22	258	49703-00	190
48510-00	160	49384-11	431	49633-24	258	49703-01	190
48511-02	161	49384-14	431	49634-00	259	49705-00	130
48512-02	161	49384-15	431	49635-00	259	49710-00	130
48513-02	161	49600-00	256	49636-00	258	49712-00	130
48514-00	160	49601-14	258	49637-00	258	49715-00	131
48515-09	161	49602-25	256	49638-00	259	49716-00	131
48515-11	161	49602-30	256	49655-02	255	49717-00	131
48515-12	161	49602-33	256	49655-03	255	49718-00	132
48516-07	161	49602-35	256	49655-10	255	49719-00	132
48516-08	161	49603-15	255	49655-16	255	49720-00	133
48516-09	161	49603-20	255	49655-20	251	49729-00	132
48517-03	161	49603-25	255	49655-21	251	49730-00	133
48518-01	161	49603-30	255	49655-22	251	49730-20	133
48518-02	161	49603-40	255	49655-23	251	49731-10	133
48519-01	162	49603-50	255	49655-24	251	49733-00	133
48519-02	162	49604-31	256	49655-25	253	49734-00	133
48519-03	162	49604-36	256	49655-26	253	49735-00	133
48519-04	162	49604-41	256	49655-27	254	49739-00	153
48520-20	162	49605-46	256	49655-28	254	49741-07	474
48520-23	162	49605-61	256	49655-29	252	49741-15	474
48520-30	162	49605-71	256	49655-30	254	49750-00	116
48522-24	162	49606-00	257	49655-31	252	49752-00	120
48523-01	161	49606-01	257	49655-32	252	49753-06	120
48523-02	161	49606-51	257	49655-34	251	49753-09	120
48523-03	161	49607-15	259	49655-35	252	49760-00	114
48523-04	161	49607-20	259	49655-36	251	49771-00	135
48524-75	162	49607-25	259	49655-37	251	49773-05	135
48525-03	162	49607-30	259	49655-38	257	49775-05	135
48526-44	162	49608-15	259	49655-40	256	49775-10	135
48527-00	162	49608-20	259	49655-41	251	49776-15	135
48528-00	162	49608-25	259	49655-42	253	49776-30	135
48529-00	162	49608-30	259	49655-43	253	49777-50	135
49304-06	427	49608-35	259	49655-44	251	49779-15	135
49335-01	444	49609-12	259	49655-45	252	49779-30	135
49335-02	444	49609-14	259	49655-46	251	49790-09	416
49336-00	444	49610-11	259	49655-47	251	49801-04	454
49336-02	444	49610-14	259	49655-48	251	49801-06	454
49337-00	444	49612-30	256	49655-49	256	49802-04	454
49337-01	444	49612-33	256	49655-50	256	49802-06	454
49371-09	452	49613-30	256	49655-51	254	49803-02	454
49371-12	452	49613-33	256	49655-52	253	49804-11	470
49373-01	431	49613-35	256	49655-53	254	49806-00	455
49373-02	431	49614-28	257	49655-54	253	49807-00	462
49373-03	431	49615-01	258	49655-55	253	49808-00	462
49373-04	431	49616-22	258	49655-56	253	49808-AC	462
49373-05	452	49616-24	258	49655-57	253	49808-AD	462
49373-11	431	49616-26	258	49655-58	253	49809-00	459
49373-12	431	49616B01	258	49655-60	253	49811-00	128
49373-13	431	49616S01	258	49655-61	254	49812-00	128
49373-14	431	49617-23	259	49655-63	256	49813-00	128

NUMERICAL INDEX INDICE NUMERICO NUMERISCH INDEX INDEX NUMERIQUE INDICE NUMERICO

<u>Cod.</u>	<u>pag.</u>	<u>Cod.</u>	<u>pag.</u>	<u>Cod.</u>	<u>pag.</u>	<u>Cod.</u>	<u>pag.</u>
49814-00	128	49850-37	458	49899-94	451	49936V11	450
49814-00	474	49850-39	458	49899-95	451	49936V12	450
49817-00	116	49850-41	457	49907-01	462	49936Y11	450
49818-00	116	49850-42	457	49907-06	462	49936Y12	450
49818-AC	116	49850-43	458	49907-AA	462	49940-01	463
49818-AD	116	49850-44	458	49911-19	463	49942-01	463
49818-AE	116	49850-60	456	49911-24	462	49942-03	463
49818-AF	116	49850-61	456	49911-30	463	49943-01	463
49819-00	115	49850-63	459	49911-35	463	49943-02	464
49819-01	115	49850-65	454	49911-45	463	49944-01	464
49819-02	115	49850-66	454	49916-25	462	49944-02	464
49821-08	115	49850-69	458	49916-35	462	49945-05	468
49823-00	121	49850-70	458	49916-45	462	49946-01	464
49823-89	121	49850-71	456	49916-55	462	49947-08	468
49823-99	121	49850-73	457	49920-00	472	49949-09	465
49825-05	120	49850-75	457	49921-00	472	49949-19	459
49826-99	121	49850-76	457	49922-01	464	49949-20	463
49827-03	122	49851-10	469	49922-02	464	49953-02	459
49827-99	121	49858-00	306	49922-03	465	49954-18	467
49829-11	120	49858-01	306	49922-04	465	49954-20	467
49830-60	120	49858-06	306	49922-06	465	49954-21	467
49832-02	118	49858-07	305	49922-08	465	49954-22	468
49832-10	118	49859-00	306	49922-09	466	49955-01	467
49833-00	386	49860-00	307	49922-20	466	49956-01	466
49834-00	116	49861-00	128	49922-21	466	49957-00	467
49835-00	116	49861-01	128	49922-22	466	49958-00	466
49836-00	116	49861-10	128	49922-23	466	49959-00	466
49837-01	115	49862-00	128	49931-00	449	49960-00	467
49837-05	115	49862-00	474	49931-60	449	49971-25	157
49838-08	115	49864-03	135	49931-64	450	49971M25	157
49838-98	115	49864-05	135	49931-87	449	49971P25	157
49839-00	114	49864-20	135	49931A00	449	49971R00	157
49842-00	115	49865-06	134	49931B01	449	49971R25	157
49843-00	117	49865-70	134	49931B02	449	49972-30	157
49843-05	126	49871-10	474	49931B03	449	49972M30	157
49844-01	125	49871-20	474	49931B05	449	49972P30	157
49845-01	114	49872-00	474	49931C04	449	49972R30	157
49846-05	470	49875-06	153	49933-30	449	49974-25	473
49846-09	470	49876-03	157	49933-50	449	49974-30	473
49846-15	470	49879-37	126	49933-68	449	49974U25	473
49847-08	471	49879-37	473	49934-04	452	49974U30	473
49847-38	470	49880-10	132	49934-06	452	49975-19	472
49850-03	460	49880-11	132	49934-08	452	49975-22	473
49850-06	458	49880-12	132	49934-14	452	49975-25	472
49850-10	458	49880-13	132	49934-16	452	49975-30	473
49850-11	457	49880-14	132	49934-18	452	49975-35	473
49850-12	457	49880-15	132	49935-45	449	49975U19	472
49850-13	456	49881-01	132	49935-68	449	49975U22	473
49850-14	456	49881-01	132	49935-87	449	49975U25	472
49850-18	455	49883-00	131	49936-10	450	49975U30	473
49850-19	455	49884-08	131	49936-13	451	49975U35	473
49850-20	454	49885-02	130	49936-14	451	49978-10	157
49850-21	455	49887-00	130	49936-15	451	49978-13	157
49850-22	455	49888-10	112	49936-16	451	49979-03	459
49850-23	455	49888-20	112	49936-17	451	49986-00	131
49850-24	460	49889-09	111	49936B11	450	49987-00	131
49850-25	460	49889-12	111	49936B12	450	49988-00	131
49850-26	460	49889-15	111	49936G11	450	49990-00	439
49850-27	460	49892-40	452	49936G12	451	49990-00	461
49850-28	460	49897-09	452	49936M11	450	49991-00	439
49850-29	460	49898-30	452	49936M12	451	49992-00	439
49850-30	460	49899-01	451	49936N11	450	49992-00	461
49850-31	460	49899-91	451	49936N12	451	49993-01	461
49850-33	456	49899-92	451	49936R11	450	49993-02	461
49850-36	457	49899-93	451	49936R12	450	49993-03	461

Cod.	pag.	Cod.	pag.	Cod.	pag.	Cod.	pag.
49993-11	461	52550-78	312	58162-56	403	58172E55	405
49993-12	461	52550-79	312	58162A54	408	58172E56	409
49993-13	461	52550-80	312	58162A55	405	58172E57	405
49993-21	461	52550-81	312	58162A56	408	58172U54	409
49993-22	461	52550-83	312	58162A57	405	58172U55	405
49993-23	461	52550-84	312	58162-AA	404	58172U56	409
49995-04	422	52550-85	312	58162E54	408	58172U57	405
49995-04	440	52550-87	312	58162E55	405	58176-30	403
49997-12	468	52550-88	312	58162E56	409	58176-36	403
49997-13	468	52550-89	312	58162E57	405	58176-40	403
49998-20	469	52550-91	312	58162-KE	405	58176A30	407
49998-35	469	56020-85	380	58162-KU	405	58176A36	407
51595B44	114	56020-99	380	58162-RA	469	58176A40	407
51595B45	114	56024-85	380	58162-RA	404	58176E30	407
52550-01	314	56024-99	380	58162-RB	469	58176E36	407
52550-02	313	56116-15	298	58162-RB	404	58176E40	407
52550-03	315	56118-20	348	58162U54	408	58176I30	405
52550-04	297	56120-18	348	58162U55	405	58176I36	405
52550-04	302	56120-22	348	58162U56	409	58176I40	405
52550-04	315	56120-24	348	58162U57	405	58176U36	407
52550-05	315	56123-00	350	58166-24	403	58176U40	407
52550-06	315	56162-00	345	58166-30	403	58341-EC	414
52550-07	315	56163-27	346	58166-36	403	58341-EM	414
52550-09	315	56163-30	346	58166-40	403	58341-ET	414
52550-11	313	56796-00	305	58166A24	407	58341-EW	414
52550-12	313	58132A54	410	58166A30	407	58341-KE	406
52550-13	313	58132A55	410	58166A36	407	58341-KE	406
52550-14	313	58132-AE	406	58166A40	407	58341-KU	406
52550-15	314	58132-AU	406	58166-AA	403	58341-KU	406
52550-16	314	58132E54	410	58166-AB	403	58341-NN	414
52550-17	314	58132E55	410	58166-AC	403	58351A06	412
52550-18	314	58132-FA	415	58166-AM	403	58351A09	412
52550-19	315	58132-FB	415	58166E24	407	58351A12	412
52550-20	314	58132-KA	406	58166E30	407	58351A18	412
52550-21	314	58132-KE	416	58166E36	407	58351E06	412
52550-22	313	58132-KU	416	58166E40	407	58351E09	412
52550-23	313	58132U54	410	58166-EB	406	58351E12	412
52550-24	314	58132U55	410	58166-EC	406	58351E18	412
52550-25	314	58136A33	411	58166-ED	407	58351U06	413
52550-26	314	58136A34	411	58166-EG	407	58351U09	413
52550-30	314	58136A40	411	58166-EH	407	58351U12	413
52550-33	314	58136A41	411	58166-EI	407	58351U18	413
52550-34	313	58136E33	411	58166-EJ	407	58353-17	398
52550-36	302	58136E34	411	58166-EL	406	58355E06	412
52550-36	315	58136E40	411	58166-EM	407	58355E09	412
52550-37	314	58136E41	411	58166I30	405	58355E12	412
52550-43	315	58136-EA	414	58166I36	405	58355-FE	416
52550-50	312	58136-EB	414	58166I40	405	58355-FU	416
52550-53	313	58136-KA	406	58166-KE	406	58355U06	412
52550-54	313	58136-KE	416	58166-KP	406	58355U09	412
52550-55	302	58136-KU	416	58166-KU	406	58355U12	412
52550-55	313	58136U33	411	58166U24	407	58357E06	470
52550-56	313	58136U34	411	58166U36	407	58357E06	412
52550-58	312	58136U40	411	58166U40	407	58357E09	470
52550-60	313	58136U41	411	58168A24	408	58357E09	412
52550-62	313	58152A54	411	58168E24	408	58357E12	470
52550-63	313	58152E54	411	58168-GA	408	58357E12	412
52550-64	313	58152U54	411	58168U24	408	58357-FE	416
52550-66	313	58156A33	412	58172-54	403	58357-FU	416
52550-68	312	58156A40	412	58172-56	403	58357U06	412
52550-69	312	58156E33	412	58172A54	409	58357U09	412
52550-70	312	58156E40	412	58172A55	405	58357U12	412
52550-73	312	58156U33	412	58172A56	409	58402-33	384
52550-74	312	58156U40	412	58172A57	405	58402-40	384
52550-77	312	58162-54	403	58172E54	409	58874-11	418

NUMERICAL INDEX INDICE NUMERICO NUMERISCH INDEX INDEX NUMERIQUE INDICE NUMERICO

<u>Cod.</u>	<u>pag.</u>	<u>Cod.</u>	<u>pag.</u>	<u>Cod.</u>	<u>pag.</u>	<u>Cod.</u>	<u>pag.</u>
58874-22	418	58893N00	422	68101D30	319		
58874M11	418	58893R00	422	68101D32	319		
58874M22	418	58895-00	421	68101D33	319		
58874N11	418	58895M00	421	68101D35	319		
58874N22	418	58895N00	421	68101D81	319		
58874R11	418	58895R00	421	68101D82	319		
58874R22	418	58897-00	421	68101D83	319		
58875-00	419	58897M00	421	68101D84	319		
58875M00	419	58897N00	421	68101L01	317		
58875N00	419	58897R00	421	68101L02	317		
58875R00	419	66303-01	271	68101L03	317		
58876-00	418	66303-03	271	68101L09	317		
58876-01	419	66303-06	271	68101L29	317		
58876M00	418	66307-06	271	68101L30	317		
58876M01	419	66307-09	271	68101L32	319		
58876N00	418	66307-12	271	68101L33	319		
58876N01	419	66313-03	272	68101L35	319		
58876R00	418	66313-06	272	68101L81	319		
58876R01	419	66318-19	273	68101L82	319		
58877-00	419	66318-22	273	68101L83	319		
58877M00	419	66320-28	380	68101L84	319		
58877N00	419	66320-35	380	68101W01	317		
58877R00	419	66320-40	380	68101W02	317		
58878-00	419	66320-50	380	68101W03	317		
58878M00	419	66320-65	380	68101W09	317		
58878N00	419	66324-40	380	68101W29	317		
58878R00	419	66324-50	380	68101W30	317		
58879-00	420	66324-65	380	68101W32	317		
58879M00	420	66325-30	380	68101W33	317		
58879N00	420	66325-35	380	68101W35	317		
58879R00	420	66325-41	380	68101W81	317		
58880-00	420	66325-46	380	68101W82	317		
58880M00	420	66325-54	380	68101W83	317		
58880N00	420	66325-85	380	68101W84	317		
58880R00	420	66325-99	380				
58882-00	420	66326-30	380				
58882M00	420	66326-35	380				
58882N00	420	66326-40	380				
58882R00	420	66326-60	380				
58884-00	420	66326-80	380				
58884M00	420	66345-55	379				
58884N00	420	66345-65	379				
58884R00	420	66345-74	379				
58886-00	418	66362-02	340				
58886M00	418	66374-00	272				
58886N00	418	66391-00	272				
58886R00	418	67303-64	272				
58887-00	418	67303M01	252				
58887M00	418	67303M02	253				
58887N00	418	67303M03	253				
58887R00	418	67303M04	252				
58888-00	422	67303M05	253				
58888M00	422	67303M06	253				
58888N00	422	67303M07	253				
58888R00	422	67303Q80	252				
58889-00	421	67303Q81	252				
58889M00	421	67303Q82	252				
58889N00	421	67303Q83	252				
58889R00	421	67305-57	252				
58891-00	421	67308-57	252				
58891M00	421	68101D01	319				
58891N00	421	68101D02	319				
58891R00	421	68101D03	319				
58893-00	422	68101D09	319				
58893M00	422	68101D29	319				

SALES CONDITIONS

CONDIZIONI DI VENDITA

LIEFERBEDINGUNGEN

CONDITIONS DE VENTE

CONDICIONES DE VENTA



General Sales Terms & Conditions

1. All orders are subject to approval and acceptance by Sambonet Paderno Industrie S.p.A.
2. Minimum order € 250,00 net.
3. Standard packaging included in the price.
4. These general sales terms & conditions may be modified only by an agreement in writing.

Ownership & Payment Terms

1. All goods remain the sole property of the Sambonet Paderno Industrie S.p.A. until payment has been made in full.
2. Title to the ownership of any delivered good shall be transferred to the client upon full payment of the price set forth in the invoice. Payment becomes due within the payment term agreed upon by the parties. Should any amount to be paid by the client become overdue, the client shall pay a late payment interest pursuant to art. 5 D.LGS. 231/2002, as subsequently amended pursuant D.LGS. 192/2012, plus an 8% interest rate.

Offers/Orders

1. Any offer of Sambonet Paderno Industrie S.p.A shall not be binding.
2. The written acceptance of any offer, or the order confirmation (according to the sales conditions included in it), constitutes a valid purchase order in accordance with the general sales terms & conditions, for all the purposes thereof.

Returns/Complaints

1. Goods must be inspected at the time of delivery.
2. Should any good be damaged or defected, the waybill shall be signed with reserve, specifying the relevant reason (pictures of the good displaying the batch number, the courier and a description of the defect must be presented).
3. Product returns must be made within 15 days of delivery, subject to the following conditions:
 - a) claims and complaints must be made through the guided procedure available on our website, www.agenti.sambonet.it, under the user section;
 - b) Goods are delivered ex works - at our premises in Orfengo;
 - c) in case of customer liability, Sambonet Paderno Industrie S.p.A. will charge 15% of the net value of the goods, with a minimum of € 25,00 for handling charges;
 - d) in case goods are returned due to our fault, Sambonet Paderno Industrie S.p.A. will replace them free of charge;
 - e) client will be responsible for all shipping costs for products purchased out of warranty that need to be returned for repairs;
 - f) customized (not included in our catalogue) and discontinued items cannot be returned. In case of serious functional and/or production faults, claims will be accepted for repair only.

Order Cancellation

1. Cancellation is not allowed in case of discontinued, custom designed, and non-stock items.
2. Catalogue items can be cancelled only if the purchase order has not yet been confirmed.

Delivery Terms in the following EU Countries:**Belgium, Netherlands, Luxembourg, France, Spain, Germany**

1. Goods are delivered **ex works** for orders having a net invoice value under € 500,00;

1.1 Goods are delivered at client's place:

- a) with a charge of € 60,00 for orders with a net value between € 500,00 and € 1,000,00;
- b) free of charge for orders with a net value over € 1,000,00.

2. Above delivery terms are valid only for shipments executed through our fixed forwarding agent.

Delivery Terms in other EU Countries (islands excluded):

1. Goods are delivered ex works for orders having an invoice value under € 500,00;

1.1 Goods are delivered at client's place:

- a) with a charge of € 60,00 for orders with net value between € 500,00 and € 1,500,00;
- b) free of charge for orders with a net value over € 1,500,00.

2. Above delivery terms are valid only for shipments executed through our fixed forwarding agent.

Delivery Terms for Extra EU Countries (islands excluded):

1. Goods are delivered ex works.

Customization (Prices hereunder are net prices)

Your logo or distinctive design can be reproduced on many patterns based on the following conditions:

- a) payment of **30% deposit** of the total amount ordered;
- b) delivery will be set after the approval of the technical drawing and/or sample
- c) Sambonet Paderno Industrie S.p.A. reserves the right to increase/decrease +/- 10% (rounded up) the shipping cost;
- d) Sambonet Paderno Industrie S.p.A. will provide the customer with a specification sheet stating all the requested data (drawing, position, sizes of logo, etc.), and will execute the order only after receipt of this sheet duly signed.

Serrated edge fruit knives (if not included in the standard series): € 0.65 per piece.

Pantograph/Laser Engraving:

- a) installation cost: € 70,00;
- b) engraving costs: flatware € 0.50 per piece - holloware, where applicable, € 1.00 per piece;
- c) minimum quantities: flatware 100 pieces per item - holloware 10 pieces per item.

Stamping:

- a) die costs: € 300,00 for the first die - additional dies € 150,00 each;
- b) stamping costs: flatware € 0.50 per piece - holloware will be quoted upon request;
- c) minimum quantities:
 - first order: flatware 1,000 pieces per item - hollow handle knives 800 pieces per item;
 - for further orders: flatware 100 pieces per item - hollow handle knives 800 pieces per item.

Special Conditions

Customized orders and special executions **cannot be cancelled**.

Customized products **cannot be returned for replacement**.

Errors may occur during the printing stage. Sambonet Paderno Industrie S.p.A. reserves the right to correct printing or calculation errors.

Flatware

We reserve the right to alter at any time the specifications stated without notice. Considering that different operations are processed manually, some slight differences between same products of different lots may be noticed. The shapes of flatware illustrated in this price list are representatives and are not to be considered as the real shape.

N.B. The goods are intended for marketing in the Country where the customer is based. If the goods are sold in a different Country, the client shall undertake to verify the regulations applicable to the goods in such Country, including customs and import rules, as well as the risk of disputes by third parties for any reason whatsoever. It being understood that the client shall hold Sambonet Paderno Industrie S.p.A. free and harmless of any claim and/or legal action from third parties arising by the sale of the goods in such different Country. Sambonet Paderno Industrie S.p.A. does not provide any guarantee regarding possible infringement of intellectual property rights of third parties, in particular in the event of resale of the goods over the internet.

Condizioni Generali e Termini di Vendita

1. Gli ordini sono soggetti ad approvazione di Sambonet Paderno Industrie S.p.A.
2. Ordine minimo € 250,00 netto merce.
3. Imballo standard gratuito.
4. Qualsiasi variazione delle presenti condizioni richiede la forma scritta.

Diritto di Proprietà e Condizioni di Pagamento

1. La merce fornita rimane di proprietà di Sambonet Paderno Industrie S.p.A. fino all'integrale pagamento della fattura da parte del cliente.
2. Il pagamento della fattura è dovuto entro il termine di pagamento preventivamente concordato tra le parti. Allo scadere di tale termine, saranno dovuti gli interessi di mora al saggio di cui all'art.5 D.LGS. 231/2002 e succ. modifiche come da D.LGS. 192/2012, maggiorato dell'8%.

Offerte/Ordini

1. Le offerte di Sambonet Paderno Industrie S.p.A. sono libere e non vincolanti all'ordine.
2. In caso di colli difettosi/danneggiati, il documento di trasporto dovrà essere firmato con riserva, specificando i motivi (vale come riserva la foto del collo con evidenza del segnacolo e nastro del corriere e descrizione del difetto).
3. I reclami saranno accettati entro **15 giorni** dalla data fattura, termine ultimo non negoziabile, alle seguenti condizioni:
 - a) la segnalazione di reclamo / richiesta di reso merce deve essere fatta attraverso la procedura guidata all'indirizzo www.agenti.sambonet.it nell'area utente;
 - b) la merce dovrà essere resa franco nostra fabbrica;
 - c) In caso di responsabilità del cliente, Sambonet Paderno Industrie S.p.A. provvederà all'addebito del 15% del prezzo netto, con un minimo di € 25,00, per costi di gestione;
 - d) in caso di accertata responsabilità di Sambonet Paderno Industrie S.p.A., la merce verrà sostituita, e resa franco domicilio cliente;
 - e) per prodotti resi per riparazione non in garanzia, le spese di spedizione e rispedizione, sono a carico del cliente;
 - f) Non saranno accettati resi per articoli speciali (non a catalogo), personalizzati o fuori produzione.

Resi/Reclami

1. La merce deve essere controllata al ricevimento.
2. In caso di colli difettosi/danneggiati, il documento di trasporto dovrà essere firmato con riserva, specificando i motivi (vale come riserva la foto del collo con evidenza del segnacolo e nastro del corriere e descrizione del difetto).
3. I reclami saranno accettati entro **15 giorni** dalla data fattura, termine ultimo non negoziabile, alle seguenti condizioni:
 - a) la segnalazione di reclamo / richiesta di reso merce deve essere fatta attraverso la procedura guidata all'indirizzo www.agenti.sambonet.it nell'area utente;
 - b) la merce dovrà essere resa franco nostra fabbrica;
 - c) In caso di responsabilità del cliente, Sambonet Paderno Industrie S.p.A. provvederà all'addebito del 15% del prezzo netto, con un minimo di € 25,00, per costi di gestione;
 - d) in caso di accertata responsabilità di Sambonet Paderno Industrie S.p.A., la merce verrà sostituita, e resa franco domicilio cliente;
 - e) per prodotti resi per riparazione non in garanzia, le spese di spedizione e rispedizione, sono a carico del cliente;
 - f) Non saranno accettati resi per articoli speciali (non a catalogo), personalizzati o fuori produzione.

Annullamento dell'ordine

1. Per i prodotti fuori catalogo, personalizzati o speciali NON è possibile annullare l'ordine.
2. Per i prodotti a catalogo, l'annullamento è possibile solo se l'ordine non è ancora stato confermato.

Condizioni di Resa Italia

1. La merce è resa franco domicilio Cliente tramite corriere convenzionato con Sambonet Paderno Industrie S.p.A.:
 - a) con addebito forfetario di € 15,00 (spese di gestione ordine) per ordini da € 250,00 a € 500,00 netto merce;
 - b) senza alcun addebito per ordini superiori a € 500,00 netto merce.
- 1.1 Qualora il Cliente richieda che le spedizioni vengano effettuate tramite il suo corriere di fiducia, le merci verranno inoltrate automaticamente in **franco fabbrica**:
 - a) con addebito forfetario di € 15,00 (spese di gestione ordine) per ordini da € 250,00 a € 500,00 netto merce;
 - b) senza alcun addebito per ordini superiori a € 500,00 netto merce.
2. Per ogni contestazione o controversia è competente il Foro di Novara.

Condizioni di Resa nei seguenti Paesi UE (isole escluse):**Belgio, Olanda, Lussemburgo, Francia, Spagna, Germania**

1. La merce è resa **franco fabbrica** per ordini inferiori a € 500,00;

1.1 La merce è resa franco domicilio Cliente:

- a) con addebito di € 60,00 per ordini da € 500,00 a € 1.000,00 netto merce;
- b) senza alcun addebito per ordini superiori a € 1.000,00 netto merce.

- 1.2 Le condizioni sopra indicate sono valide solo per spedizioni tramite corriere convenzionato con Sambonet Paderno Industrie S.p.A.

Condizioni di Resa nei restanti Paesi UE (isole escluse):

1. La merce è resa franco fabbrica per ordini inferiori a € 500,00;

1.1 La merce è resa franco domicilio Cliente:

- a) con addebito di € 60,00 per ordini da € 500,00 a € 1.500,00 netto merce;
- b) senza alcun addebito per ordini superiori a € 1.500,00 netto merce.

- 1.2 Le condizioni sopra indicate sono valide solo per spedizioni tramite corriere convenzionato con Sambonet Paderno Industrie S.p.A.

Condizioni di Resa Paesi extra-UE

1. La merce è resa franco fabbrica.

Personalizzazioni (I costi indicati sono da intendersi netti)

Sambonet Paderno Industrie S.p.A. effettua su richiesta del Cliente personalizzazioni ed esecuzioni particolari alle seguenti condizioni:

- a) versamento di **acconto del 30%** sul valore dell'ordine;
- b) consegna da convenire dopo l'approvazione disegno esecutivo e/o campione;
- c) Sambonet Paderno Industrie S.p.A. si riserva la facoltà di applicare, per ogni singolo articolo, una tolleranza pari a +/- 10%, con arrotondamento all'unità superiore, nella spedizione dei quantitativi ordinati;
- d) Sambonet Paderno Industrie S.p.A. provvederà a fornire al Cliente una scheda con l'indicazione di tutti i parametri necessari (disegno, posizione, dimensioni, ecc.) e procederà alla fornitura solo al ricevimento della stessa firmata per accettazione.

Seghettatura lame coltelli frutta: ove non prevista di serie, con addebito di € 0,65 al pezzo.

Incisione al Pantografo/Laser:

- a) costo impianto: € 70,00;
- b) costo incisione: posateria € 0,50 al pezzo - vasellame, incisione ove possibile, € 1,00 al pezzo;
- c) quantità minime: posateria 100 pezzi per articolo - vasellame 10 pezzi per articolo.

Punzonatura:

- a) costo punzoni: il primo punzone € 300,00 - i successivi € 150,00 cad;
- b) costo punzonatura: posateria € 0,50 al pezzo - vasellame preventivo su richiesta;
- c) quantità minime:
 - nuovi impianti: posateria 1.000 pezzi per articolo - coltelli manico cavo 800 pezzi per articolo;
 - riordini: posateria 100 pezzi per articolo - coltelli manico cavo 800 pezzi per articolo.

Condizioni speciali

Ordini personalizzati e/o esecuzioni particolari non standard **non possono essere annullati**. I prodotti personalizzati **non possono essere resi per sostituzione**.

In fase di stampa sono possibili errori e/o omissioni. Sambonet Paderno Industrie S.p.A. si riserva il diritto di rettifica di eventuali errori di stampa o calcolo.

Posateria

Le misure espresse sono indicative e soggette a variazioni senza preavviso. In considerazione del fatto che la produzione è artigianale, potrebbero rilevarsi lievi differenze tra partite diverse dello stesso prodotto. Le sagome delle posate illustrate di questo listino sono puramente indicative e non si riferiscono alle sagome reali.

N.B. La merce è destinata alla commercializzazione nel Paese in cui ha sede il cliente. Qualora la merce sia commercializzata in un Paese differente, sarà onere del cliente verificare le normative applicabili in tale Paese incluse le normative doganali e di importazione, nonché il rischio di contestazioni da parte di terzi a qualunque titolo, restando inteso che Sambonet Paderno Industrie S.p.A. sarà manlevata e tenuta indenne dal cliente per quanto causato dalla vendita della merce in tale diverso Paese. Sambonet Paderno Industrie S.p.A. non fornisce alcuna garanzia in ordine a possibili contestazioni di violazione di diritti di proprietà industriale ed intellettuale di terzi, in particolare nell'ipotesi di rivendita della merce a mezzo Internet.

DEU

Allgemeine Verkaufsbedingungen

- Bestellungen sind erst nach Bestätigung durch Sambonet Paderno Industrie S.p.A. gültig.
- Mindestwarenbestellwert € 250,00 netto.**
- Standardverpackung kostenlos.
- Änderungen dieser Bedingungen bedürfen der Schriftform.

Eigentumsrecht und Zahlungsbedingungen

- Die gelieferte Ware bleibt bis zur vollständigen Bezahlung der Rechnung durch den Kunden Eigentum der Sambonet Paderno Industrie S.p.A.
- Die Bezahlung der Rechnung muss innerhalb der zwischen den Parteien zuvor vereinbarten Zahlungsfrist erfolgen. Nach Ablauf dieser Frist werden Verzugszinsen in der in Art. 5 der [italienischen gesetzestretenden Verordnung] D. Lgs. 231/2002 (in der durch D. Lgs. 192/2012 geänderten Fassung) vorgesehenen Höhe zuzüglich 8 % fällig.

Angebote/Bestellungen

- Angebote von Sambonet Paderno Industrie S.p.A. sind freibleibend.
- Mit der schriftlichen Annahme des Angebots oder der Auftragsbestätigung (mit allen enthaltenen Bedingungen) wird eine in jeder Hinsicht wirksame Bestellung aufgegeben, die mit der Ausführung eines Vertrags gemäß den allgemeinen Verkaufsbedingungen verbunden ist.

Rückgaben/Reklamationen

- Die Ware ist bei Erhalt zu kontrollieren.
- Sollten Pakete defekt/beschädigt sein, so ist das Transportdokument unter Vorbehalt und mit Angabe der Gründe (z. B. ein Foto der Ware, auf der die Kennzeichnung der Ware und die Spedition erkennbar sind, und eine Beschreibung des Defekts) zu unterschreiben.

Reklamationen werden innerhalb von 15 Tagen nach Rechnungsdatum als letzte nicht verhandelbare Frist unter folgenden Bedingungen angenommen:

- Die Reklamation/der Antrag auf Rücknahme der Ware erfolgt über das angeleitete Verfahren im Benutzerbereich der Website www.agenti.sambonet.it;
- Die Lieferung erfolgt frei unserem Werk;
- Liegt die Verantwortung für die Rückgabe beim Kunden, Sambonet Paderno Industrie S.p.A. stellt 15 % des Nettopreises, jedoch mindestens € 25,00 als Bearbeitungskosten in Rechnung;
- Liegt die Verantwortung nachgewiesenermaßen bei Sambonet Paderno Industrie S.p.A., wird die Ware ersetzt und dem Kunden frei Haus zugestellt;
- Im Falle von Produkten, die zur Reparatur zurückgegeben werden und keiner Gewährleistung unterliegen, gehen die Kosten für Zu- und Rücksendung zu Lasten des Kunden;
- Nicht angenommen werden Rücksendungen von Sonderartikeln (nicht im Katalog), kundenindividuellen Artikeln und Artikeln, deren Produktion eingestellt wurde.

Stornierung der Bestellung

- Bestellungen von Produkten, die nicht im Katalog enthalten oder die kundenindividuell gefertigt sind, oder Bestellungen von Sonderartikeln können NICHT storniert werden.
- Bei Produkten aus dem Katalog ist eine Stornierung nur möglich, wenn die Bestellung noch nicht bestätigt wurde.

Lieferbedingungen für die folgenden EU-Länder (Inseln ausgeschlossen):

Belgien, Niederlande, Luxemburg, Frankreich, Spanien, Deutschland

1. Die Lieferung der Ware erfolgt frei Werk bei Bestellungen unter einem Wert von € 500,00.

1.1 Die Lieferung zum Kunden erfolgt frei Haus, wobei:

- bei einem Warenbestellwert zwischen € 500,00 und € 1.000,00 netto eine Pauschale von € 60,00 in Rechnung gestellt wird;
- bei einem Warenbestellwert über € 1.000,00 netto keine Versandkosten in Rechnung gestellt werden.

1.2 Die vorstehenden Bedingungen gelten nur für den Versand mit dem Vertragsspediteur von Sambonet Paderno Industrie S.p.A.

Lieferbedingungen für die übrigen EU-Länder (Inseln ausgeschlossen)

1. Die Lieferung der Ware erfolgt **frei Werk** bei Bestellungen unter einem Wert von € 500,00.

1.1 Die Lieferung **zum Kunden** erfolgt **frei Haus**, wobei:

- bei einem Warenbestellwert zwischen € 500,00 und € 1.500,00 netto eine Pauschale von € 60,00 in Rechnung gestellt wird;
- bei einem Warenbestellwert über € 1.500,00 netto keine Versandkosten in Rechnung gestellt werden.

1.2 Die vorstehenden Bedingungen gelten nur für den Versand mit dem Vertragsspediteur von Sambonet Paderno Industrie S.p.A.

Lieferbedingungen für Länder außerhalb der EU

1. Die Lieferung erfolgt frei Werk.

Kundenindividuelle Anfertigungen (die angegebenen Kosten verstehen sich als Nettobeträge)

Auf Wunsch des Kunden stellt Sambonet Paderno Industrie S.p.A. kundenindividuelle und Sonderanfertigungen her. Es gelten die folgenden Bedingungen:

- Es wird eine **Anzahlung in Höhe von 30 %** des Bestellwertes geleistet;
- Die Lieferung wird nach der Freigabe der endgültigen Gestaltung und/oder des Musters vereinbart;
- Sambonet Paderno Industrie S.p.A. behält sich in Bezug auf den Versand der bestellten Mengen für jeden einzelnen Artikel einen **Toleranzwert** von +/- 10 % mit Aufrundung auf die nächsthöhere Einheit vor;
- Sambonet Paderno Industrie S.p.A. legt dem Kunden ein Beschreibungsblatt mit allen erforderlichen Parametern (Zeichnung, Platzierung, Abmessungen usw.) vor. Die Lieferung erfolgt erst, nachdem der Kunde dieses zum Zeichen der Annahme unterschrieben und zurückgesendet hat.

Wellenschliff Obstmesser, wenn nicht serienmäßig vorgesehen, Aufpreis von € 0,65 pro Stück.

Gravur mit Pantograf/Laser

- Einrichtungskosten: € 70,00;
- Gravurkosten: Besteck € 0,50 pro Stück – Geschirr, sofern Gravur möglich, € 1,00 pro Stück;
- Mindestmengen: Besteck 100 Stück je Artikel – Geschirr: 10 Stück je Artikel.

Stanzungen:

- Spunzen: erste Punze € 300,00 – jede weitere € 150,00;
- Stanzkosten: Besteck € 0,50 pro Stück – Geschirr: bitte Kostenvoranschlag anfordern;
- Mindestmengen:
 - Erstbestellung: Besteck 1.000 Stück je Artikel – Messer mit Hohlheftgriff 800 Stück je Artikel;
 - Folgebestellungen: Besteck 100 Stück je Artikel – Messer mit Hohlheftgriff 800 Stück je Artikel.

Sonderkonditionen

Bestellungen von kundenindividuellen und/oder nicht standardmäßigen Sonderanfertigungen **können nicht storniert werden**.

Kundenindividuell gefertigte Artikel **können nicht umgetauscht werden**.

Beim Druck kann es zu Fehlern und/oder Auslassungen kommen. Sambonet Paderno Industrie S.p.A. behält sich die Korrektur von Druck- oder Rechenfehlern vor.

Bestecke

Wir behalten uns das Recht vor, die angegebenen Spezifikationen jederzeit zu ändern. Da verschiedene Bearbeitungsschritte handwerksmäßig ausgeführt werden, könnten leichte Abweichungen bei unterschiedlichen Warenpartien des selben Produktes auftreten. Das Profil der Bestecke ist nur als Informationsskizze zu verstehen. Es stellt nicht dar die wirklichen Profile.

N.B. Die Ware ist für die Vermarktung in dem Land, in dem der Kunde ansässig ist, bestimmt. Wenn die Ware in einem anderen Land vermarktet wird, liegt es in der Verantwortung des Kunden, die in diesem Land geltenden Vorschriften einschließlich Zoll- und Einfuhrbestimmungen sowie das Risiko von Streitigkeiten durch Dritte aus irgendeinem Grund zu überprüfen. Es versteht sich, dass Sambonet Paderno Industrie S.p.A. für jede mögliche Streitigkeit, die durch den Verkauf der Ware in diesem anderen Land entstehen kann, schadlos gehalten wird. Sambonet Paderno Industrie S.p.A. übernimmt keine Garantie für eventuelle Ansprüche wegen Verletzung von gewerblichen Schutzrechten und Rechten des geistigen Eigentums Dritter, insbesondere im Falle des Weiterverkaufs der Ware über Internet.

FRA

Termes et conditions générales de vente

- Toute commande est soumise à l'acceptation de Sambonet Paderno Industrie S.p.A.
- Le montant minimum de commande est de € 250,00 net HT.**
- Emballage standard gratuit.
- Toute modification de ces conditions doit se faire par écrit.

Droit de propriété et conditions de paiement

- Les marchandises fournies restent la propriété de Sambonet Paderno Industrie S.p.A. jusqu'au paiement intégral de la facture par le client.
- La facture doit être réglée dans le délai préalablement convenu entre les parties. Tout retard de paiement entraîne l'application d'intérêts calculés au taux fixé par l'article 5 du décret législatif italien 231/2002 tel que modifié par le décret législatif italien 192/2012, majoré de 8%.

Offres/Commandes

- Les offres de Sambonet Paderno Industrie S.p.A. sont libres et n'engagent pas à passer une commande.
- L'acceptation d'une offre par écrit, ou la confirmation de la commande (et les manières qui sont contenu), sera réputée une véritable commande, qui entraîne l'exécution d'un contrat conforme aux termes et aux conditions générales de vente.

Retours/Reclamations

- Les marchandises doivent être contrôlées à la réception.
- En cas de colis défectueux / endommagés, le document de transport devra être signé sous réserve, en spécifiant les raisons (la photo du colis avec l'étiquette logistique et le ruban du transporteur bien en évidence, accompagnée de la description du défaut, vaut réserve).
- Les réclamations doivent être soumises dans un délai maximum non négociable de 15 jours à compter de la date de la facture, aux conditions suivantes:

- la réclamation / la demande de retour de marchandises doit être soumise en suivant la procédure assistée disponible à l'adresse www.agenti.sambonet.it dans l'espace utilisateur;
- Tous les retours de marchandises sont départ notre usine;
- en cas de responsabilité du client, Sambonet Paderno Industrie S.p.A. facturera 15% du prix net, avec un montant minimum de € 25,00, pour les frais de gestion;
- en cas de responsabilité avérée de Sambonet Paderno Industrie S.p.A., les marchandises seront remplacées et retournées franco domicile client;
- pour les produits retournés pour réparation hors garantie, les frais de transport aller-retour sont à la charge du client;
- les retours d'articles spéciaux (hors catalogue), personnalisés ou hors production ne sont pas acceptés.

Annulation des commandes

- Les commandes de produits hors catalogue, personnalisés ou spéciaux ne peuvent pas être annulées.
- Les commandes de produits sur catalogue ne peuvent être annulées que si la commande n'a pas encore été confirmée.

Conditions de livraison pour les suivants Pays de l'UE (îles exclues) :

Belgique, Pays Bas, Luxembourg, France, Espagne, Allemagne

1. Les envois de marchandises sont **départ usine** pour tout montant de commande inférieur à € 500,00.

1.1 Les envois de marchandises sont **franco domicile client**:

- avec € 60,00 à la charge du client pour tout montant net HT de commande de € 500,00 à € 1.000,00;
- sans aucune charge pour tout montant net HT de commande supérieur à € 1.000,00.

1.2 Les conditions susmentionnées ne sont valables que pour les envois effectués par le transporteur conventionné avec Sambonet Paderno Industrie S.p.A.

Conditions de livraison pour les autres Pays de l'UE (îles exclues)

1. Les envois de marchandises sont **départ usine** pour tout montant de commande inférieur à € 500,00.

1.1 Les envois de marchandises sont **franco domicile client**:

- avec € 60,00 à la charge du client pour tout montant net HT de commande de € 500,00 à € 1.500,00;
- sans aucune charge pour tout montant net HT de commande supérieur à € 1.500,00.

1.2 Les conditions susmentionnées ne sont valables que pour les envois effectués par le transporteur conventionné avec Sambonet Paderno Industrie S.p.A.

Conditions de livraison pour les Pays n'appartenant pas à l'UE

1. Tous les envois de marchandises sont départ usine.

Produits personnalisés (les prix indiqués sont nets)

Sambonet Paderno Industrie S.p.A. est en mesure de réaliser des produits personnalisés à la demande du client aux conditions suivantes:

- paiement d'un **acompte de 30%** sur le montant de la commande;
- livraison à convenir après l'approbation du dessin exécutif et/ou de l'échantillon;
- Sambonet Paderno Industrie S.p.A. se réserve le droit d'appliquer à chaque référence une tolérance de livraison sur les quantités commandées de +/- 10% arrondie à l'unité supérieure;
- Sambonet Paderno Industrie S.p.A. enverra au client une fiche avec toutes les données techniques nécessaires (dessin, position, dimensions, etc.) et n'exécutera la commande qu'à la réception de la fiche signée pour autorisation.

Couteaux à dessert exécutés avec **lame dentelée** (si cette lame n'est pas la lame standard): € 0,65 par pièce.

Gravure pantographe/laser:

- frais de commande: € 70,00;
- frais de gravure: couverts € 0,50 par pièce - plats et articles de table, si gravure faisable, € 1,00 par pièce;
- quantité minimum de commande: couverts 100 pièces pour chaque référence - plats et articles de table 10 pièces pour chaque référence.

Poinçonnage:

- frais de poinçonnage: € 300,00 pour le premier poinçon - € 150,00 pour chaque poinçon supplémentaire;
- frais de poinçonnage: couverts € 0,50 par pièce - plats et articles de table: devis sur demande;
- quantité minimum de commande:
 - première commande: couverts 1.000 pièces par référence - couteaux poignée creuse 800 pièces par référence;
 - commandes suivantes: couverts 100 pièces par référence - couteaux poignée creuse 800 pièces par référence.

Conditions spéciales

Les commandes de produits personnalisés e/o spéciaux **ne peuvent pas être annulées**.

Les produits personnalisés **ne peuvent pas être retournés pour remplacement**.

Des fautes et/ou des omissions peuvent survenir lors de l'impression. Sambonet Paderno Industrie S.p.A. se réserve le droit de corriger toute faute d'impression ou de calcul.

Couverts

Nous nous réservons le droit de modifier à tout moment les spécifications techniques. Car différents cycles de production sont effectués artisanalement, on pourrait remarquer des légères différences entre différents lots du même produit.

Les silhouettes des couverts de ce tarif sont uniquement indicatives et elles ne se réfèrent pas à la silhouette réelle des couverts.

N.B. Les produits sont destinés à la commercialisation dans le Pays où le client est basé. Si les produits sont vendus dans un autre Pays, il est de la responsabilité du client de vérifier les réglementations applicables dans ce Pays, y compris les réglementations douanières et d'importation, ainsi que le risque de litiges par des tiers pour quelque motif que ce soit, étant entendu que Sambonet Paderno Industrie S.p.A. sera déchargé de tout litige qui pourrait survenir dans ce Pays différent. Sambonet Paderno Industrie S.p.A. ne fournit aucune garantie quant à d'éventuelles actions pour violation des droits de propriété industrielle et intellectuelle par des tiers, en particulier en cas de revente du produit sur Internet.

Condiciones generales y de venta

1. Los pedidos deben ser aprobados por Sambonet Paderno Industrie S.p.A.
2. Pedido mínimo de € 250,00 en factura.
3. Embalaje estándar incluido.
4. Cualquier variación de las presentes condiciones debe realizarse por escrito.

Derecho de propiedad y condiciones de pago

1. La mercancía queda de propiedad de Sambonet Paderno Industrie S.p.A. hasta que el cliente realice el pago total de la factura.
2. El plazo de pago de la factura debe realizarse dentro de los términos establecidos previamente por las partes. Al caducar dicho plazo, deberán considerarse los intereses de demora según lo dispuesto por el art. 5 D.LGS 231/2002 y siguientes modificaciones, como previsto en el D.LGS. 192/2012, con aumento del 8%.

Ofertas/Pedidos

1. Las ofertas de Sambonet Paderno Industrie S.p.A. son libres y no vinculantes al pedido.
2. Aceptando por escrito la oferta, o de la confirmación del pedido (con la modalidad en ella incluidas) se produce a todos los efectos un pedido que implica un contrato conforme a las condiciones generales y de venta.

Restituciones/Reclamaciones

1. La mercancía debe controlarse en el momento de la entrega.
2. En caso de embalajes defectuosos/deteriorados, el documento de transporte se deberá firmar bajo reserva especificando las razones (como reserva se debe presentar la foto del embalaje y su código de barra, la cinta del servicio de transporte y la descripción de la avería).
3. Las reclamaciones se aceptarán dentro de **15 días** a partir de la fecha de emisión de la factura, plazo no negociable, bajo las condiciones que se citan a continuación:
 - a) La reclamación/solicitud de restitución de mercancía debe realizarse a través del procedimiento guiado en la página web: www.agenti.sambonet.it en el área de usuarios;
 - b) La mercancía se entrega franco nuestra fábrica;
 - c) En caso de que el cliente sea responsable, Sambonet Paderno Industrie S.p.A. le cargará el 15% del precio neto, con un mínimo de € 25,00 de coste de gestión;
 - d) En caso de responsabilidad comprobada de Sambonet Paderno Industrie S.p.A., la mercancía será reemplazada y entregada al cliente con porte pagado;
 - e) los gastos de transporte para la reparación de productos sin garantía, corren a cargo del cliente;
 - f) para los artículos especiales (no incluidos en el catálogo), personalizados o fuera de producción no será posible restituir la mercancía.

Cancelación del pedido

- a) para los productos no incluidos en el catálogo, personalizados o especiales NO es posible cancelar el pedido.
- b) para los productos incluidos en el catálogo, es posible cancelar el pedido sólo en caso de que aún no haya sido confirmado.

Condiciones de entrega en los siguientes Países UE

Bélgica, Holanda, Luxemburgo, Francia, España, Alemania

1. Los pedidos cuyo importe no alcance los € 500,00 se remiten **franco fábrica**.

1.1 La mercancía se remite a **porte pagado**:

- a) cargando € 60,00 para pedidos de entre € 500,00 y € 1.000,00 netos;
- b) sin cargo alguno si el pedido neto sobrepasa los € 1.000,00.

- 1.2 Las condiciones mencionadas arriba deben considerarse válidas sólo para los servicios de transporte elegidos por Sambonet Paderno Industrie S.p.A.

Condiciones de entrega en los demás Países UE (islas excluidas)

1. Los pedidos cuyo importe no alcance los € 500,00 se remiten **franco fábrica**.

1.1 La mercancía se remite a **porte pagado**:

- a) cargando € 60,00 para pedidos de entre € 500,00 y € 1.500,00 netos;
- b) sin cargo alguno si el pedido neto sobrepasa los € 1.500,00.

- 1.2 Las condiciones mencionadas arriba deben considerarse válidas sólo para los servicios de transporte elegidos por Sambonet Paderno Industrie S.p.A.

Condiciones de entrega en los Países extra UE (islas excluidas)

1. La mercancía se entrega **franco fábrica**.

Personalizaciones (Los precios indicados deben considerarse netos)

Bajo solicitud del cliente, Sambonet Paderno Industrie S.p.A. realiza personalizaciones y acabados particulares según las siguientes condiciones:

- a) **pago de un anticipo del 30%** del valor del pedido;
- b) La entrega será establecida tras aprobar el diseño ejecutivo y/o la muestra;
- c) Sambonet Paderno Industrie S.p.A. se reserva el derecho de aplicar, en cada artículo, una **tolerancia** del +/- 10%, redondeando por exceso, para el envío de las cantidades solicitadas;
- d) Sambonet Paderno Industrie S.p.A. enviará al cliente una ficha con toda la información necesaria (diseño, posición, medidas, ecc). La entrega se efectuará sólo después de haber recibido la ficha firmada por el cliente.

Endentado de hojas cuchillos poste: si no previsto de serie, con cargo de € 0,65 / pieza.

Grabado por Pantógrafo/Láser:

- a) coste instalación: € 70,00;
- b) coste grabado: cubiertos € 0,50 / pieza - vajilla, grabado (si es posible) € 1,00 / pieza;
- c) cantidades mínimas. Cubiertos: 100 piezas por modelo - vajilla: 10 piezas por modelo.

Punzonado:

- a) coste punzones: € 300,00 para el primer punzón - € 150,00 para los siguientes (cada uno);
- b) coste punzonado: cubiertos € 0,50 / pieza - vajilla: solicitando un presupuesto;
- c) pedidos mínimos:
 - nuevas instalaciones. Cubiertos: 1.000 piezas por modelo - cuchillos de mango hueco: 800 piezas por modelo;
 - pedidos adicionales. Cubiertos: 100 piezas por modelo - cuchillos de mango hueco: 800 piezas por modelo.

Condiciones especiales

Pedidos personalizados y/o acabados particulares **no se pueden cancelar**. **No se pueden devolver, para su reemplazo**, los productos personalizados.

Al imprimir puede que surjan errores y/o omisiones. Sambonet Paderno Industrie S.p.A. se reserva el derecho a rectificar eventuales errores de impresión o de cálculo.

Cubiertos

Nos reservamos el derecho de modificar las medidas indicadas sin aviso previo. Puesto que diferentes fases del mecanizado se efectúan con un cuidado artesanal, podrían manifestarse pequeñas diferencias entre distintos lotes del mismo artículo. Los perfiles de los cubiertos de la lista de precios son meramente simbólicos y no corresponden a los perfiles reales.

N.B. Los productos están destinados a la comercialización en el País donde se encuentra el cliente. Si los productos se comercializan en un País diferente, será responsabilidad del cliente verificar las regulaciones aplicables en ese País, incluidas las regulaciones de aduanas e importación, así como el riesgo de disputas por parte de terceros por cualquier motivo, entendiéndose que Sambonet Paderno Industrie SpA estará libre de cualquier disputa que pueda surgir en este País diferente. Sambonet Paderno Industrie S.p.A. no ofrece ninguna garantía con respecto a posibles reclamos de violación de derechos de propiedad industrial e intelectual de terceros, en particular en el caso de reventa de los productos a través de Internet.

FOTO - PHOTO

Riccardo Bianchi
Felice Scoccimarro

STAMPA - PRINT

Graphicscalve S.p.A.

MEMBER
OF 

ARCTURUS GROUP

© COPYRIGHT

- Ogni riproduzione anche parziale del presente catalogo è vietata se non espressamente autorizzata per iscritto da Sambonet Paderno Industrie S.p.A.
- This catalogue may not be reproduced in whole or in part unless specific prior written authorization of Sambonet Paderno Industrie S.p.A.
- Die Vervielfältigung dieses Katalogs -auch wenn partial- ohne unsere ausdrückliche schriftliche Erlaubnis ist untersagt.
- Toute reproduction ou reproduction partielle de ce catalogue est interdite sauf expressément autorisée par Sambonet Paderno Industrie S.p.A.
- Queda prohibida la reproducción total o parcial de este catálogo sin autorización de forma expresa y por escrito de Sambonet Paderno Industrie S.p.A.

NOTE - NOTES

- Le misure, caratteristiche ed illustrazioni dei prodotti sono indicative e soggette a variazioni senza preavviso qualora esigenze tecnico produttive lo richiedessero.
- The pictures illustrated and data are representatives. We reserve the right to alter at any time the specifications stated without notice, whenever technical requirements shall so demand.
- Fotos und Abmessungen sind nur als information zu verstehen. Wir behalten uns das Recht vor, die angegebenen Spezifikationen jederzeit zu ändern, sofern es aus produktionstechnischen Gründen erforderlich ist.
- Les photos et dimensions indiquées sont indicatives. Nous nous réservons le droit de modifier à tout moment les spécifications techniques, si la situation l'exige.
- Fotos, datos y medidas que aparecen en este catálogo son indicativos y susceptibles, sin previo aviso, de modificación por exigencias técnicas o de producción.

ICONS - SIMBOLOGIA - SYMBOLE - SYMBOLES - ICONOS



No microwave safe
Non idoneo a microonde



No oven safe
Non idoneo a forno



Suitable for electric stoves
Adatto per fornelli elettrici



Suitable for glass-ceramic stoves
Adatto per fornelli in vetroceramica



Suitable for induction stoves
Adatto per fornelli a induzione



Suitable for gas stoves
Adatto per fornelli a gas



For gluten free food
Per alimenti senza glutine



Cooling
Refrigerabile



Heated
Riscaldato



Water resistant
Resistente all'acqua



NO water resistant
NON resistente all'acqua



With light
Con luce



Food safe
Per alimenti



Stackable
Impilabile



GN size
Misure GN



Battery powered
Alimentato a batterie



Hand wash
Lavare a mano



Do not use sharp objects
Non usare oggetti taglienti



Do not use on open flames
Non utilizzare su fiamme libere



Dishwasher safe
Lavabile in lavastoviglie



No dishwasher safe
Non lavabile in lavastoviglie



Microwave safe
Idoneo a microonde



Oven safe
Idoneo a forno

PADERNO[®]



WORLD CUISINE

www.hotel.paderno.it
www.hotel.sambonet.it

MEMBER
OF 
ARCTURUS GROUP

XA9060 - Ed. 10/2019

8 014808 181825

